

2013



mAntra

...siente la luz

MEDITERRÁNEO

DESIGN
HUGO TEJADA
2013

El efecto lumínico como protagonista, el valor de las sombras y las luces proyectadas por un objeto luminoso, Mediterráneo está diseñada para ser un concepto imperecedero, no es un objeto de tendencia, está destinado a perdurar en el tiempo. Mediterráneo se inspira en el movimiento de las olas, sus líneas orgánicas acentúan el carácter amigable de su pantalla, creando una sensación mágica a lo largo de su superficie de cristal. Gracias a la utilización de cristal de alta calidad la luz se difumina homogéneamente generando una iluminación dulce e íntima. La colección está compuesta por una gran variedad de aplicaciones y acabados metálicos, perfecta para ser utilizada en ambientes íntimos y acogedores o en grandes instalaciones.

The lighting effect as protagonist, the value of shade and light projected in a luminous object, Mediterráneo is designed to be an enduring concept, It is not a trend object, It is destined to last over time. Mediterráneo is inspired by the movement of the waves, organic lines accentuate the kind of their screen, creating a magical effect along their glass surface. By using high quality glass, the light is sweet and intimate. The collection consists of a variety of applications and metallic finishes, this is perfect for use in intimate and cozy places or large premises





MEDITERRÁNEO

DESIGN
HUGO TEJADA
2013

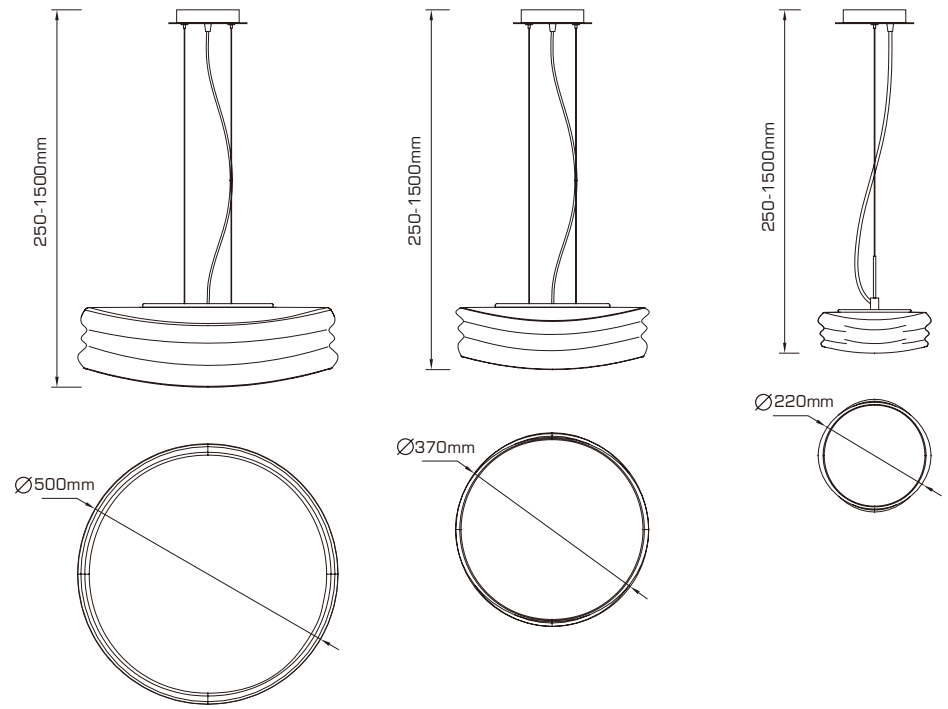

Mediterraneo 3620

▨ cristal opal / crome
opal glass / chrome
💡 3 × Max.13W E27



Mediterraneo 3621

▨ cristal opal / crome
opal glass / chrome
💡 2 × Max.13W E27



Mediterraneo 3622

▨ cristal opal / crome
opal glass / chrome
💡 2 × Max.9W GU10





MEDITERRÁNEO

DESIGN
HUGO TEJADA
2013





Mediterraneo 3625

▨ cristal opal / blanco epoxi
 opal glass / white
 2 × Max.9W GU10

Mediterraneo 3624

▨ cristal opal / blanco epoxi
 opal glass / white
 2 × Max.13W E27

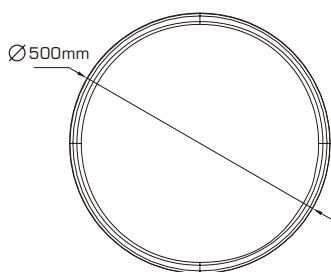
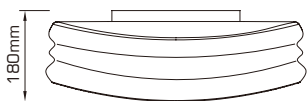
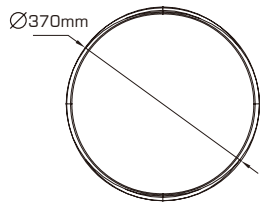
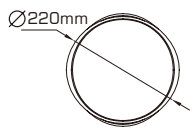
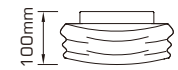

Mediterraneo 3623

▨ cristal opal / blanco epoxi
 opal glass / white
 3 × Max.13W E27



MEDITERRÁNEO

DESIGN
HUGO TEJADA
2013

Mediterraneo 3628

▨ cristal opal /cromo
opal glass /chrome
💡 2 × Max.13W E27 bajo



Mediterraneo 3626

▨ cristal opal /cromo
opal glass /chrome
💡 2 × Max.13W E27



Mediterraneo 3627

▨ cristal opal /cromo
opal glass /chrome
💡 2 × Max.9W GU10



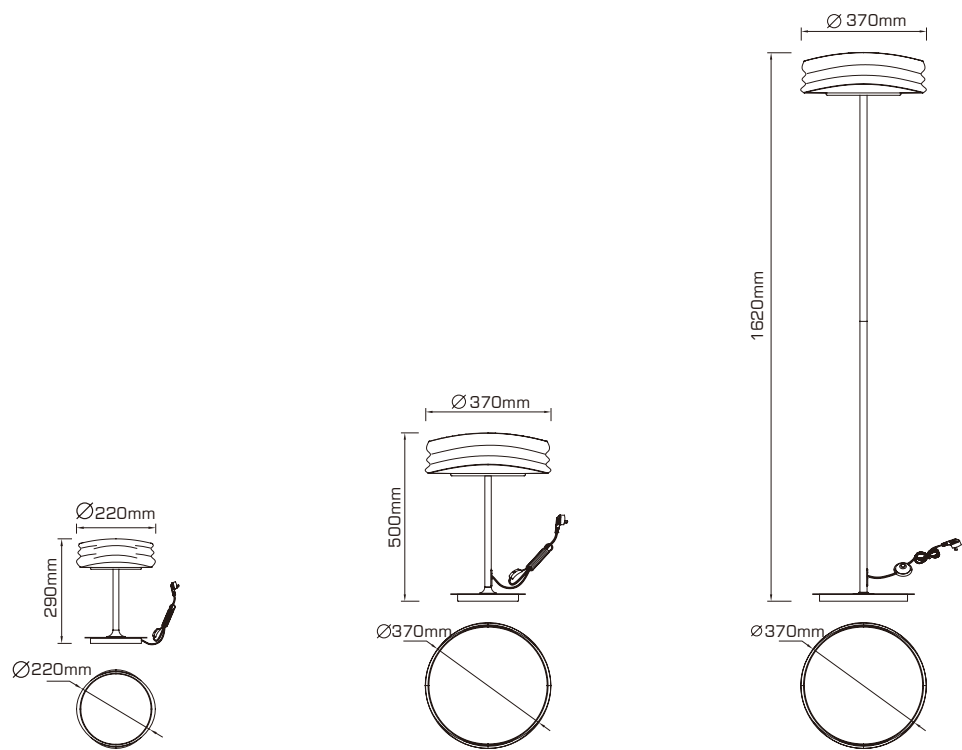

MEDITERRÁNEO

DESIGN
HUGO TEJADA
2013





Colección On
On Coleccion



Diseño/Design Equipo Mantra.



On



On 3561

■ acrílico blanco / crome
white acrylic / chrome

☀ led 4 x 6W

On

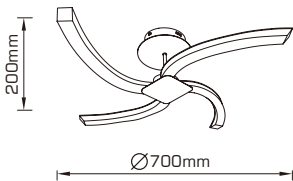



On 3560
■ acrílico blanco / crome
white acrylic / chrome
☰ led 5 x 6W

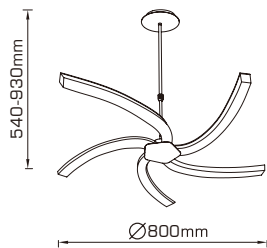

On

On

On 3563

▨ acrílico blanco / crome
white acrylic / chrome
💡 led 1 x 6W



On 3564

▨ acrílico blanco / crome
white acrylic / chrome
💡 led 1 x 6W

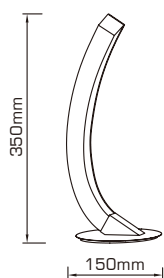

3564

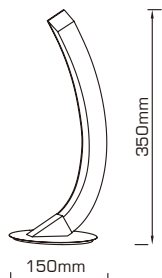

3563

On



On 3562

■ acrílico blanco / crome
white acrylic / chrome

☰ led 3 x 6W

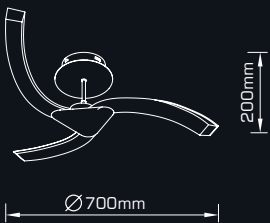

On 3565

■ acrílico blanco / crome
white acrylic / chrome

☰ led 1 x 6W

On 3566

■ acrílico blanco / crome
white acrylic / chrome

☰ led 1 x 6W

On

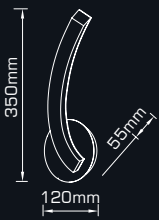

3566



3565

On

Bambú

Diseno /Design Santiago Sevillano.





Bambú

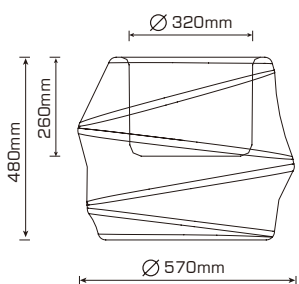

Bambú 3651
lacado blanco / white lacquer

Bambú 3652
lacado negro / black lacquer

Bambú 3653
lacado rojo / red lacquer

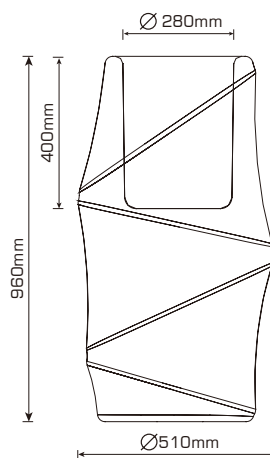

Bambú 3654
lacado blanco / white lacquer

Bambú 3655
lacado negro / black lacquer

Bambú 3656
lacado rojo / red lacquer

Bambú





Bambú 3646 (IP65)

blanco / white

2 x Max.13W E27 bajo cons.
save energy (no incl)



Bambú 3643 (IP65)

blanco / white

1 x Max.13W E27 bajo cons.
save energy (no incl)

Bambú 3647

blanco / white

no light

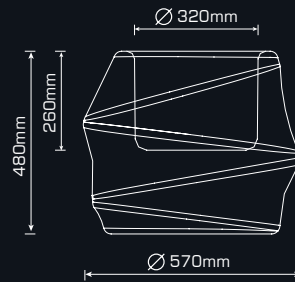
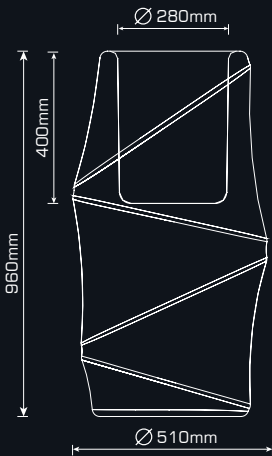





Bambú 3640 (IP44)

blanco / white
 2 x Max.13W E27 bajo cons.
 save energy (no incl)

Bambú 3641 (IP65)

blanco / white
 cristal 8mm. Glass 8mm.
 1 x Max.13W E27 bajo cons.
 save energy (no incl)

Bambú

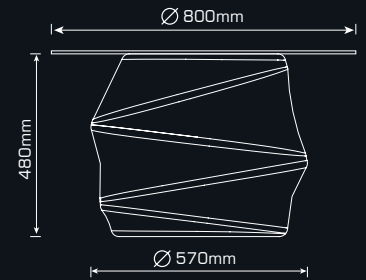
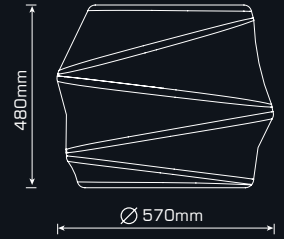
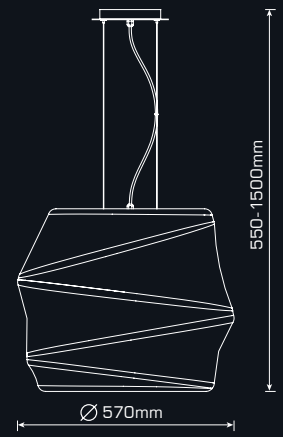

Bambú 3649 (IP65)

blanco / white
 1 x Max.13W E27 bajo cons.
 save energy (no incl)

Bambú 3650

blanco / white
 no light





Bambú



Diseño /Design Santiago Sevillano.



Looker

Looker



Looker 3615

Blanco / madera
white / wood
1 x Max.15W E27 (no incl.)



Looker 3613

Blanco / rosa
white / pink
1 x Max.15W E27 (no incl.)



Looker 3614

Blanco / verde
white / green
1 x Max.15W E27 (no incl.)

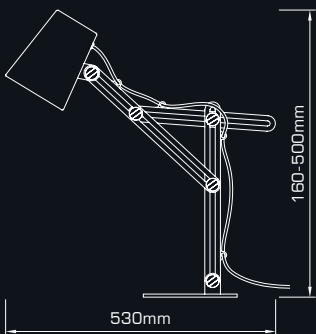

Looker



Looker 3613

Looker





2331



2333



2332

2331

- Cromo brillo / Chrome
- Plafon Cristal
- D50 x H34 cm
- 8 x G9 Max 40W

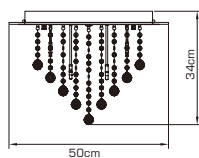

2332

- Cromo brillo / Chrome
- Plafon Cristal
- D30 x H20 cm
- 6 x G9 Max 40W

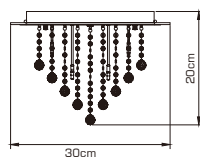

2333

- Cromo brillo / Chrome
- Plafon Cristal
- D20 x H14 cm
- 3 x G9 Max 40W

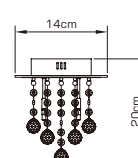



2774



2773



2663



2775

2663

/// Cromo brillo / Chrome

Plafon de Cristal

D36 x H15 cm

4 x G9Max 40W

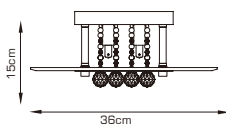

2773

/// Cromo brillo / Chrome

Plafon de Cristal

D39 x H15 cm

4 x G9 Max 40W

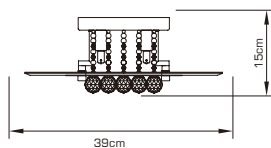

2774

/// Cromo brillo / Chrome

Plafon de Cristal

D50 x H15 cm

6 x G9 Max 40W

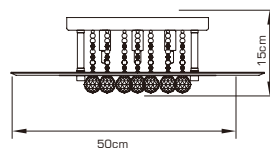

2775

/// Cromo brillo / Chrome

Plafon de Cristal

D50 x H15 cm

6 x G9 Max 40W

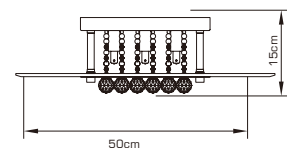



mantra



mantra

Polígono Industrial Los Vientos
Calle Alisio, Parcela 4
46119 Náquera
Valencia - SPAIN
Tel.: +34 96 160 99 50
Fax: +34 96 160 99 48
mail: mantra@mantraco.org
visit: www.mantraco.org