

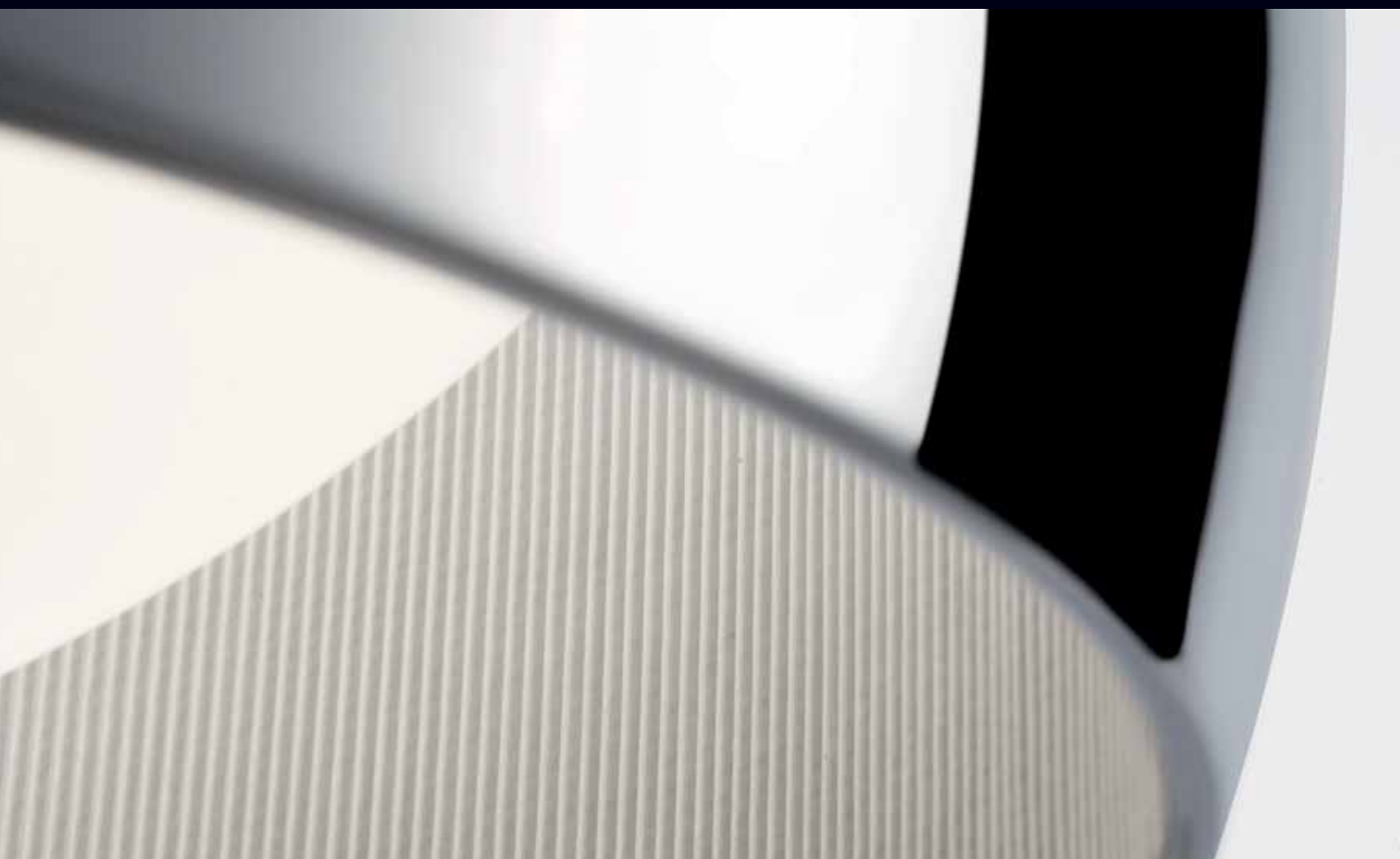

**GROK**

CATÁLOGO GENERAL 2010  
GENERAL CATALOGUE 2010



 **LED S-C4**



**GROK**

---

## Benedito Design

Beauty's utility.  
La utilidad de la belleza.



## Jantze, Brogård & Asshoff Design

We beautify and simplify our surroundings to improve the everyday life.  
Embellecemos y simplificamos nuestro entorno para mejorar el día a día

## Josep Patsí

When art and technique come together.  
Cuando arte y técnica se encuentran.



## Estudi Ribaudí

We work in a world where ideas are born, we make them grow and we transform them into objects.  
Trabajamos en el mundo donde nacen las ideas, las hacemos crecer y las transformamos en objetos

## WIS Design

Wisdom and poetry for everyday objects.  
Sabiduría y poesía para los objetos cotidianos.



## Xavi Muixí

It allows us to appreciate all the beauty surrounding us, each project is a tribute to make a tribute, The Light.  
Ella nos permite apreciar todo lo bello que nos rodea, cada proyecto es un intento de rendirle tributo, La Luz.

# \_Designers

Benedito Design  
Jantze, Brogård & Asshoff Design  
Josep Patsí  
Estudi Ribaudí  
WIS Design  
Xavi Muixí





\_Índice  
\_Index  
\_Index  
\_Index  
\_Índice

\_colgantes  
 \_pendants  
 \_suspensions  
 \_pendelleuchten  
 \_lampade a sospensione



adagio\_36-38-39

balloons\_12 new



class\_34



clear\_18 new



duna\_46



everyday\_26



leila\_30-32



linear\_48



oxygen\_44



scala\_35



shi\_28



siluet\_16 new



slimm\_42



swing\_52



tempo\_40



troppo\_20



twins\_50



umbrella\_22



\_apliques  
 \_wall fixtures  
 \_appliques  
 \_wandleuchten  
 \_lampade da parete



adagio\_68      arc\_66      boomerang\_78      ciao\_80



class\_84      dolce\_102      duna\_82      escher\_62      flat\_74



hotels\_98      ibis\_174      leila\_96      level\_71      mini\_178-180



mirror\_86      moon\_177      nemo\_148 <sup>new</sup>      ola\_103      open\_90      oxygen\_70



quattro\_184      scala\_104      ska\_182      slight\_144 <sup>new</sup>      slimm\_72



suite\_92      suite\_94      tempo\_76      traç\_56 <sup>new</sup>      troppo\_60      versatil\_100

\_sobremesas  
 \_table lamps  
 \_lampes de tables  
 \_tischleuchten  
 \_lampade da tavolo



adagio\_118      adn\_123      arc\_114      bonne nuit\_120      class\_122



escher\_110      everyday\_126      gloria\_128      hotels\_130      leila\_132



office\_138      open\_136      soul\_131      suite\_134      suite\_135



totem mini\_140      troppo\_116      umbrella\_124

\_plafones  
 \_ceiling fixtures  
 \_plafoniers  
 \_deckenleuchten  
 \_plafoniere



adagio\_166      adn\_188      basic\_168-170-171



diana\_176      escher\_156      ibis\_174      mini\_178-180      moon\_177



nemo\_148 new

ocho\_162-164

ona\_158

quattro\_184

ska\_182



slight\_144-146 new

slimm\_186

square\_172

traç\_150 new

tropo\_152

\_pies salón  
 \_floor lamps  
 \_lampadaires  
 \_stehleuchten  
 \_lampade da terra



adagio\_209

adn\_204

arc\_206

class\_208

escher\_194

everyday\_200

everyday outdoor\_196

fiore\_223



hotels\_214

leila\_212

open\_220

scala\_222

slimm\_210

soul\_215

suite\_218

suite\_216

totem\_224

tropo\_192

umbrella\_202





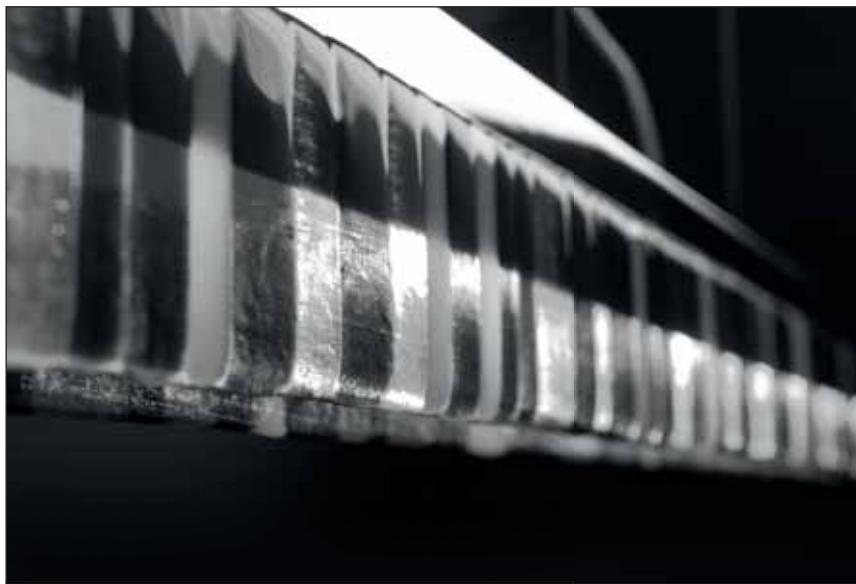

\_colgantes  
\_pendants  
\_suspensions  
\_pendelleuchten  
\_lampade a sospensione

balloons\_12  
siluet\_16  
clear\_18  
troppo\_20  
umbrella\_22  
everyday\_26  
shi\_28  
leila\_30  
class\_34  
scala\_35  
adagio\_36  
tempo\_40  
slimm\_42  
oxygen\_44  
duna\_46  
linear\_48  
twins\_50  
swing\_52



# balloons new

design \_ Josep Patsi

Estructura y detalles de metal acabado en cromo. Difusor de cristal opal soplado de color blanco mate que permite luz directa e indirecta. Cable de tela. Interior plisado en tela blanca que distribuye la luz en todas direcciones.

Chrome metal body and details. Matte-white blown opal glass diffuser that gives direct and indirect light. Cord cable. White pleated fabric interior that distributes light in all directions.

Structure et détails en métal avec finitions chromées. Diffuseur blanc mat en verre opale soufflé, qui permet la lumière directe et indirecte. Câble en tissu. Intérieur en tissu blanc plissé qui distribue la lumière.

Gehäuse und Details aus verchromtem Metall. Diffusor aus geblasenem Opalglas, Farbe mattweiß, zur direkten und indirekten Beleuchtung geeignet. Textilkabel. Plissierter Innenschirm aus weißem Stoff zur Verteilung des Lichts in alle Richtungen.

Struttura e particolari in metallo, con finitura cromata. Diffusore in cristallo opale soffiato, in colore bianco opaco, che consente luce diretta e indiretta. Cavo in tela. Interno plissettato in tela bianca, che distribuisce la luce in tutte le direzioni.





Cromo  
 Chrome  
 21 Chrome  
 Chrom  
 Cromo

Cristal opal triplex  
 Triplex Opal glass  
 F9 Verre opal triplex  
 Optishes Glas  
 Vetro ottico

**00-4348-21-F9**  
 E-27 Max. 150W  
 HALOGEN  
 PL E-27 30W  
 ENERGY SAVING



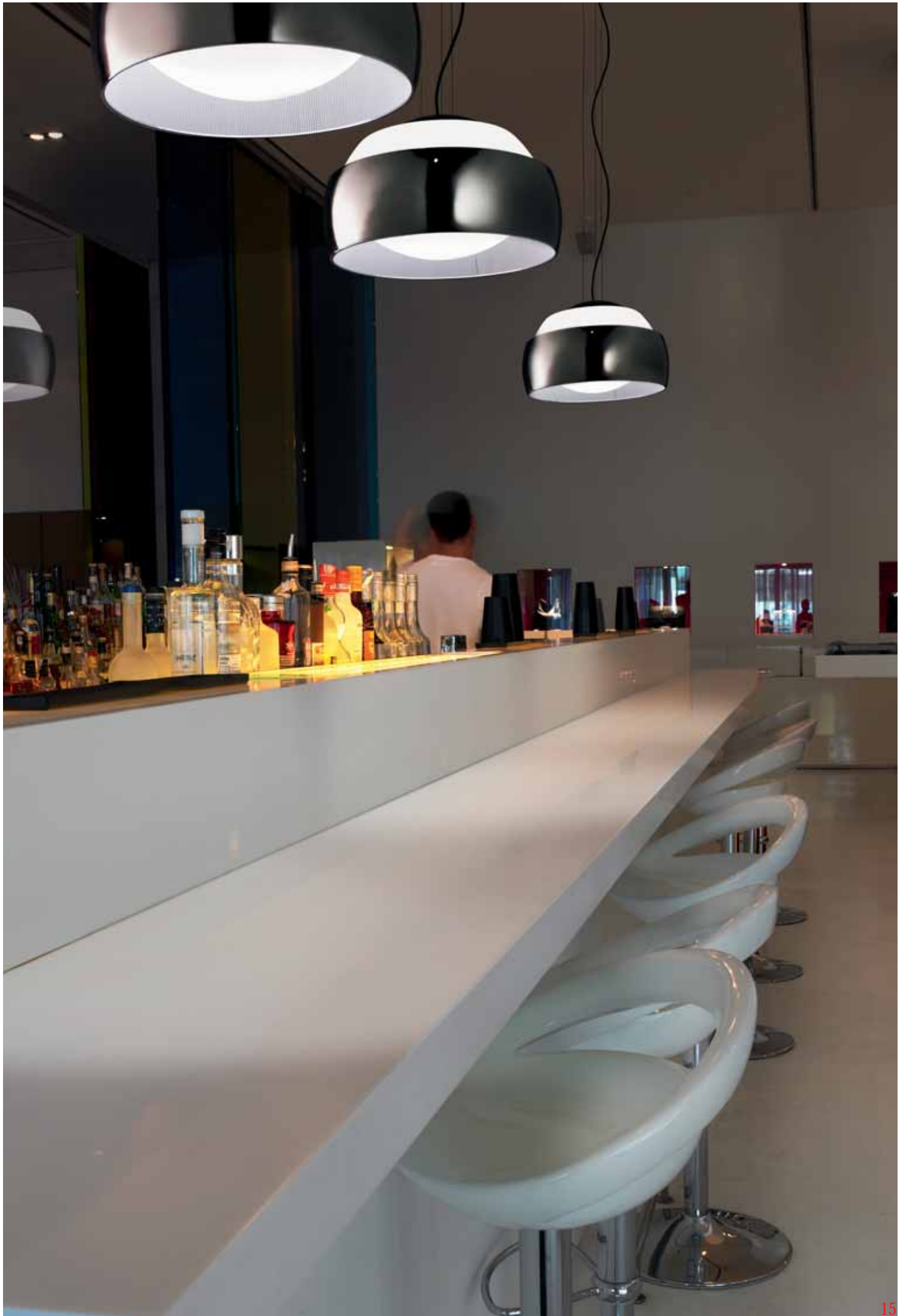



Estructura de poliuretano pintado en color blanco. Difusor de policarbonato matizado. Cable forrado en tela. Luz directa e indirecta.

Polyurethane body painted in white. Matte polycarbonate diffuser. Cord cable. Direct and indirect light.

Structure en polyuréthane peint en blanc. Diffuseur en polycarbonate teinté. Câble en tissu rayé. Lumière directe et indirecte.

Gehäuse aus Polyurethan, weiß lackiert. Diffusor aus matten Polykarbonat. Stoffisoliertes Kabel. Zur direkten und indirekten Beleuchtung.

Struttura in poliuretano dipinto, di colore bianco. Diffusore in policarbonato opacizzato. Cavo rivestito di tela. Luce diretta e indiretta.

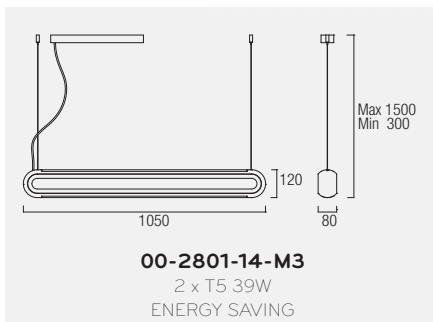

Iluminación indirecta  
Indirect light



Iluminación directa  
Direct light



- |                                    |  |
|------------------------------------|--|
| ○ Blanco<br>White                  | ○ Policarbonato mate<br>Matt polycarbonate                               |
| <b>14</b> Blanc<br>Weiss<br>Bianco | <b>M3</b> Polycarbonate mat<br>Matter Polykarbonat<br>Polycarbonato matt |





# clear <sup>new</sup>

design \_ Josep Patsí

Estructura metálica acabada en cromo negro. Cable de tela. El difusor óptico de policarbonato transparente permite una luz ideal para ambientes íntimos.

Black chrome metal body and details. Cord cable. The transparent polycarbonate optical diffuser provides ideal lighting for intimate atmospheres.

Structure métallique avec finitions chromées noires. Câble en tissu. Le diffuseur optique en polycarbonate transparent diffuse une lumière idéale pour les atmosphères intimes.

Gehäuse aus verchromtem Metall in Schwarz. Textilkabel. Diffusor aus transparentem Polykarbonat, ideal zur diskreten Ambientebeleuchtung.

Struttura metallica rifinita con cromatura nera. Cavo in tela. Il diffusore ottico in policarbonato trasparente consente la luce ideale per ambienti raccolti.

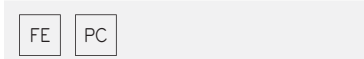

● Cromo negro  
Black chrome  
Chrome noir  
Schwartz Chrom  
Cromo nero

○ Policarbonato transparente  
Transparent polycarbonate  
**M2** Polycarbonate transparent  
Transparenter Polykarbonat  
Polycarbonato transparente

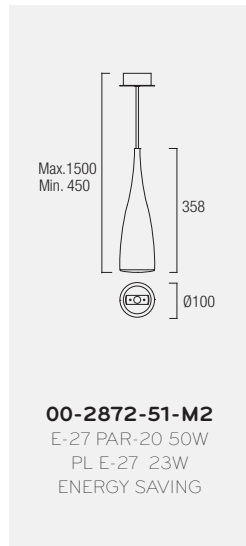





# tropo

design\_Benedito Design

tropo\_collection

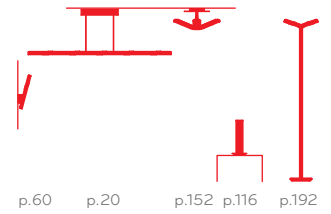

Estructura de aluminio acabado en cromo. Cristales de borosilicato matizado. Elegante combinación de formas simples: líneas y círculos. Emite luz directa y también indirecta gracias a las aperturas de la parte superior de la estructura.

Chrome aluminium body. Matte borosilicate glass. Elegant combination of simple shapes - lines and circles. Provides direct and indirect light thanks to openings at the top of the luminaire.

Structure en aluminium avec finitions chromées. Verre borosilicate teinté. Combinaison élégante de formes simples telles que des lignes et des cercles. Émet une lumière directe mais aussi indirecte grâce aux ouvertures de la partie supérieure de la structure.

Gehäuse aus verchromtem Aluminium. Mattes Borosilikatglas. Elegante Kombination einfacher Formen: Linien und Kreise. Direkte Beleuchtung sowie indirekte Beleuchtung durch die Öffnungen an der Oberseite der Leuchte.

Struttura in alluminio con finitura cromata. Cristalli di borosilicato opacizzato. Elegante accostamento di forme semplici: linee e cerchi. Emette luce diretta e indiretta, anche grazie alle aperture della parte superiore della struttura.



- Cromo      ○ Cristal anti-deslumbrante
- Chrome     Anti-glare glass
- 21** Chrome   **F1** Verre antiéblouissante
- Chrom      Blendfreies Glas
- Cromo      Vetro antiriflesso

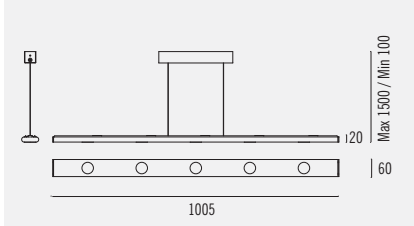

**00-2804-21-F1**

5 x G9 Max. 75W HALOGEN OSRAM included



# umbrella

design \_ WIS design

umbrella\_collection

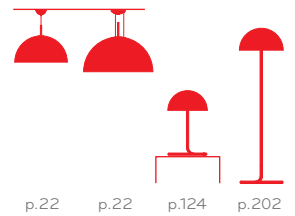

Estructura semiesférica disponible en acabados blanco y negro. Difusor de cristal óptico matizado. Interior plisado disponible en plateado y dorado respectivamente. Disponible en 2 diámetros, 60cm y 100cm. Cable de tela. Luz directa.

Semispherical body available in black and white. Matte optical glass diffuser. Pleated interior available in silver and gold. Available in 2 sizes: 60 cm and 100 cm. Cord cable. Direct light.

Structure semisphérique avec finitions proposées en noir et en blanc. Diffuseur en verre optique teinté. Intérieur plissé disponible en argenté ou en doré. Décliné en deux diamètres: 60 cm et 100 cm. Câble en tissu. Lumière directe.

Halbrundes Gehäuse, in Weiß und Schwarz lieferbar. Diffusor aus mattem Optikglas. Mit silber- oder goldfarbenen plissiertem Innenschirm lieferbar. In 2 Durchmessern lieferbar: 60 cm oder 100 cm. Textilkabel. Direkte Beleuchtung.

Struttura semisferica, disponibile con finitura bianca e nera. Diffusore in cristallo ottico opacizzato. Interno plissettato disponibile nella versione argentata e dorata. Disponibile in 2 diametri, 60 cm e 100 cm. Cavo in tela. Luce diretta.



**AP** Pantalla interior plisada dorada  
Golden pleated interior shade  
Intérieur d'abat-jour plissé doré  
Schirm, Innenseite Gold plissee  
Paralume interna plisata oro

**05** Lacado negro  
Black lacquered  
Laqué en noir  
Schwarz lackiert  
Laccato nero

**AQ** Pantalla interior plisada plata  
Silver pleated interior shade  
Intérieur d'abat-jour plissé argenté  
Schirm, Innenseite Silver plissee  
Paralume interna plisada argento

**78** Lacado blanco  
White lacquered  
Laqué en blanc  
Weiss lackiert  
Laccato bianco

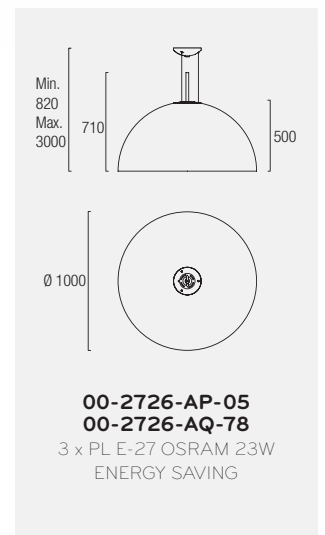
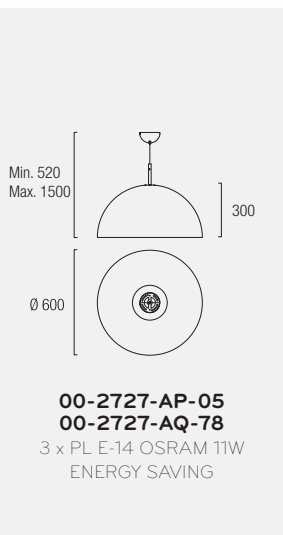





umbrella





# everyday

design \_ JBA design

everyday\_collection

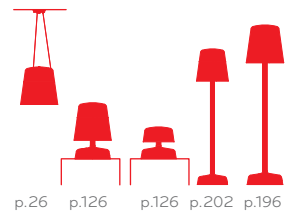

Estructura metálica blanca combinada con un difusor de cristal opal que oculta completamente la fuente de luz. Cable de tela.

White metal body combined with an opal glass diffuser that completely hides the light source. Cord cable.

Structure métallique blanche associée à un diffuseur en verre opale qui cache entièrement la source de lumière. Câble en tissu.

Gehäuse aus Metall, weiß lackiert. Kombiniert mit Diffusor aus Opalglas, der die Lichtquelle komplett verdeckt. Textilkabel.

Struttura metallica in colore bianco, abbinata a un diffusore in cristallo opale, che cela completamente la fonte luminosa. Cavo in tela.

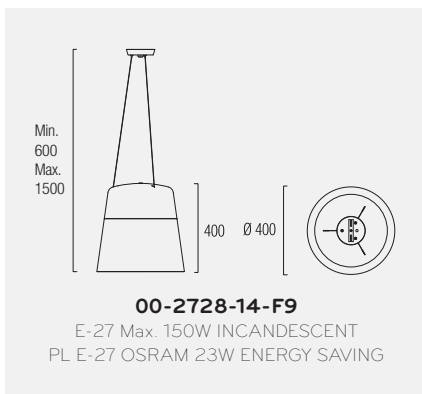

- |                 |                              |
|-----------------|------------------------------|
| ○ Blanco        | ○ Cristal opal triplex       |
| ○ White         | ○ Triplex Opal glass         |
| <b>14</b> Blanc | <b>F9</b> Verre opal triplex |
| ○ Weiss         | ○ Optisches Glas             |
| ○ Bianco        | ○ Vetro ottico               |







# shi

design \_ Josep Patsi

Estructura y esfera metálicas en acabado aluminio mate. Difusor de cristal opal disponible en negro y en blanco. Luz inferior directa. Luz superior de ambiente, que permite el cambio de color gracias al mando a distancia incluido.

Matte aluminium body and sphere. Opal glass diffuser available in black and white. Direct lower light. Ambient upper light that can change colour using the remote control included.

Structure et sphère métalliques avec finitions en aluminium mat. Diffuseur en verre opale proposé en noir et en blanc. Lumière inférieure directe. Lumière supérieure d'ambiance avec changement de couleur grâce à la télécommande fournie.

Gehäuse und Kugel aus Metall, Oberfläche matted Aluminium. Diffusor aus Opalglas, lieferbar in Schwarz und in Weiß. Unteres Licht direkte Beleuchtung. Oberes Licht Ambientebeleuchtung, mit Farbwechsel über mitgelieferter Fernbedienung.

Struttura e sfere metalliche con finitura in alluminio opaco. Diffusore in cristallo opale, disponibile in nero e in bianco. Luce inferiore diretta. Luce ambiente superiore, che consente di cambiare il colore grazie al telecomando fornito.

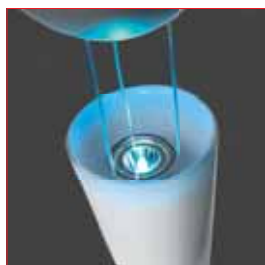

Cambio de color LED con mando a distancia  
LED color changing with remote control  
Changement de couleur par télécommande à distance  
LED Farbwechsel mit Fernbedienung  
Cambio di colore del LED con comando



Y5	Aluminio mate Matt aluminium Aluminium mat Alluminium matt Alluminio opaco	05	Cristal opal negro Black opal glass Verre opale noir Schwarzes Opalglas Vetro opal nero
14	Cristal opal blanco White opal glass Verre opale blanc Weisses Opalglas Vetro opal bianco		

**00-2725-Y5-05**  
**00-2725-Y5-14**  
E-27 Max. 100W INCANDESCENT  
GU10 LEDS 5W Included



# leila

design\_Benedito Design

leila\_collection

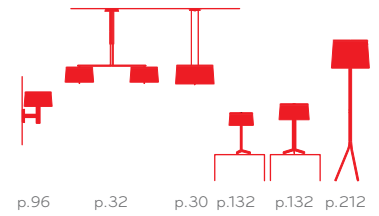

Estructura metálica en acabado cromo y aluminio satinado. Pantallas de tela disponibles en negro y en blanco. Difusor de metacrilato matizado. Sistema de doble iluminación Up & Down. Regulación de la luz superior mediante dimmer y inferior mediante ON-OFF. Luz directa e indirecta.

Chrome or satin aluminium body. Fabric shades available in black and white. Matte methacrylate diffuser. Up & Down double lighting system. Upper light regulated using dimmer switch and lower light by using on/off switch. Direct and indirect light.

Structure métallique avec finitions chromées et en aluminium satiné. Écrans en tissu, proposés en noir et en blanc. Diffuseur en méthacrylate teinté. Système à double éclairage «Up & Down». Réglage de la lumière supérieure par variateur et de la lumière inférieure par interrupteur. Lumière directe et indirecte.

Metallgehäuse, Oberfläche verchromt und aus satiniertem Aluminium. Stoffschirme in Schwarz und Weiß lieferbar. Diffusor aus matiertem Plexiglas. Doppeltes Beleuchtungssystem Up & Down. Regulierung des Oberlichts mit Dimmer und Regulierung des Unterlichts mit Ein-/Aus-Schalter. Zur direkten und indirekten Beleuchtung.

Struttura metallica con finitura cromata e alluminio satinato. Paralumi in tela disponibili in colore nero e bianco. Diffusore in metacrilato opacizzato. Sistema a doppia illuminazione Up & Down. Regolazione della luce superiore tramite un dimmer e di quella inferiore tramite ON-OFF. Luce diretta e indiretta.



ON - OFF

ILUMINACIÓN INFERIOR (E-27)  
BOTTOM LIGHTING (E-27)



ON - OFF

DIMMER

DIMMER  
ILUMINACIÓN SUPERIOR (G9)  
TOP LIGHTING (G9)

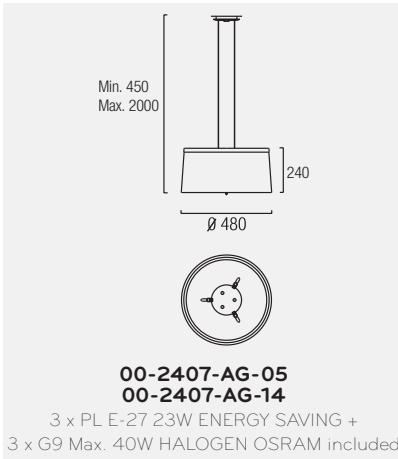

Metacrilato matizado / Methacrylate diffuser



**AG** Aluminio con cromo  
Aluminium with chrome  
Aluminium avec chrome  
Aluminium mit Chrom  
Alluminio con cromo

**05** Pantalla negra de tela incluida  
Black fabric shade included  
Abat-jour noir en tissu compris  
Schwarz Schirm inklusiv  
Paralume di tela nero inclusa

**14** Pantalla blanca de tela incluida  
White fabric shade included  
Abat-jour blanche en tissu compris  
Weiss Schirm inklusiv  
Paralume di tela bianca inclusa







ON - OFF

ILUMINACIÓN INFERIOR (E-14)  
BOTTOM LIGHTING (E-14)



ON - OFF

DIMMER

**DIMMER**

ILUMINACIÓN SUPERIOR (G9)  
TOP LIGHTING (G9)

Dimmer para la iluminación superior en una pantalla e interruptor ON-OFF para la iluminación inferior en la otra pantalla

Dimmer for the top lighting in one shade, and ON-OFF switch for bottom lighting in the other shade

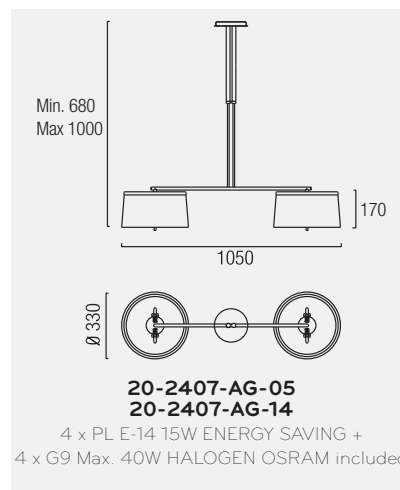

Metacrilato matizado / Methacrylate diffuser





# class

design \_ Josep Patsí

class\_collection

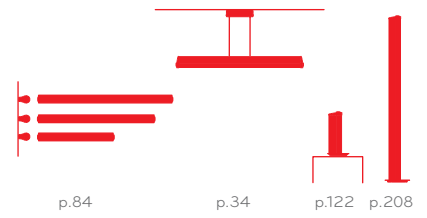

Estructura de aluminio Ecobright. Doble difusor: interior de policarbonato opal y exterior de borosilicato transparente. Luz directa.

Ecobright aluminium body. Double diffuser - inner: opal polycarbonate, exterior: transparent borosilicate Direct light.

Structure en aluminium Ecobright. Double diffuseur : intérieur en polycarbonate opale et extérieur en borosilicate transparent. Lumière directe.

Gehäuse aus Ecobright-Aluminium. Doppelter Diffusor: Innen aus Opal-Polykarbonat und außen aus transparentem Borosilikat. Direkte Beleuchtung.

Struttura in alluminio Ecobright. Doppio diffusore: interno in policarbonato opale ed esterno in borosilicato trasparente. Luce diretta.



Doble difusor  
Double diffuser  
Diffuseur double  
Doppelglas  
Difusore doppio

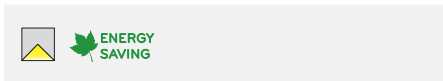
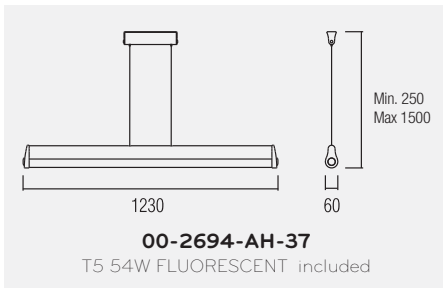

Aluminio Ecobright  
Ecobright aluminium  
**AH** Aluminium Ecobright  
Ecobright aluminium  
Alluminio Ecobright



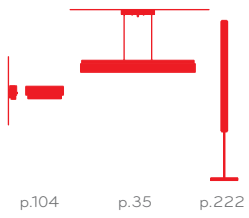

Estructura metálica en acabado cromo. Difusor de cristal fusing con tonos color cava. Luz directa.

Chrome metal body. Fusing glass diffuser in pale yellow tones. Direct light.

Structure métallique avec finitions chromées. Diffuseur en verre fondu avec des tons champagne. Lumière directe.

Gehäuse aus verchromtem Metall. Diffusor aus Fusing-Glas mit Sektfarbtönen. Direkte Beleuchtung.

Struttura metallica con finitura cromata. Diffusore in cristallo fusing, con toni color champagne. Luce diretta.

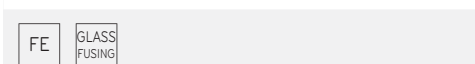
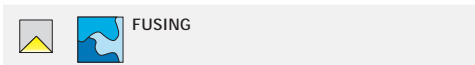
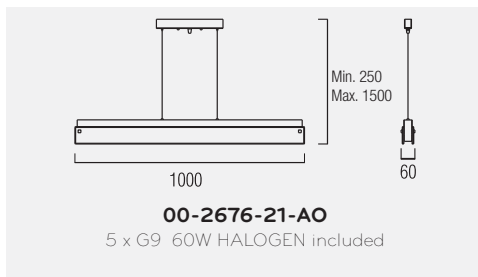

- Cromo
- Chrome
- 21** Chrome
- Chrom
- Cromo
- Cristal fusing cava
- Fusing cava glass
- AO** Verre fusing "cava"
- Sektfarbiges-fusing-Glas
- Vetro fusing cava



# adagio

design \_ Josep Patsí

adagio\_collection

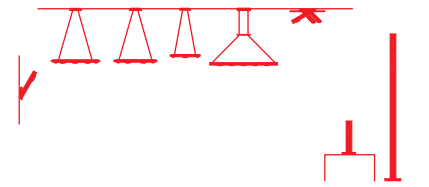

p.68 p.38 p.39 p.38 p.36 p.166 p.118 p.209

Estructura de aluminio y difusores de cristal anti-deslumbrante. Disponible en 4 versiones: lineal, cuadrada, rectangular de 6 y 8 luces. Disponible en acabados cromo y aluminio pulido satinado. Luz directa e indirecta.

Aluminium body and anti-glare glass diffusers. Available in 4 versions: line, square, 6-light and 8-light rectangle. Available in chrome or polished and satin aluminium. Direct and indirect light.

Structure en aluminium et diffuseurs en verre antireflets. Proposée en quatre versions : linéaire, carrée et rectangulaire avec six/huit lumières. Finitions chromées d'une part, et polies et satinées en aluminium d'autre part. Lumière directe mais aussi indirecte.

Gehäuse aus Aluminium und Diffusore aus entspiegeltem Glas. In 4 Ausführungen lieferbar: Linear, quadratisch, rechteckig 6 Lampen und 8 Lampen. Alle Ausführungen sind auch mit verchromter Oberfläche und aus poliertem satiniertem Aluminium lieferbar. Direkte Beleuchtung sowie indirekte Beleuchtung.

Struttura in alluminio e diffusori in cristallo anti-abbagliamento. Disponibile in 4 versioni: lineare, quadrata, rettangolare a 6 luci e a 8 luci. Disponibili con finitura cromata e finitura in alluminio lucido satinato. Luce diretta e indiretta.

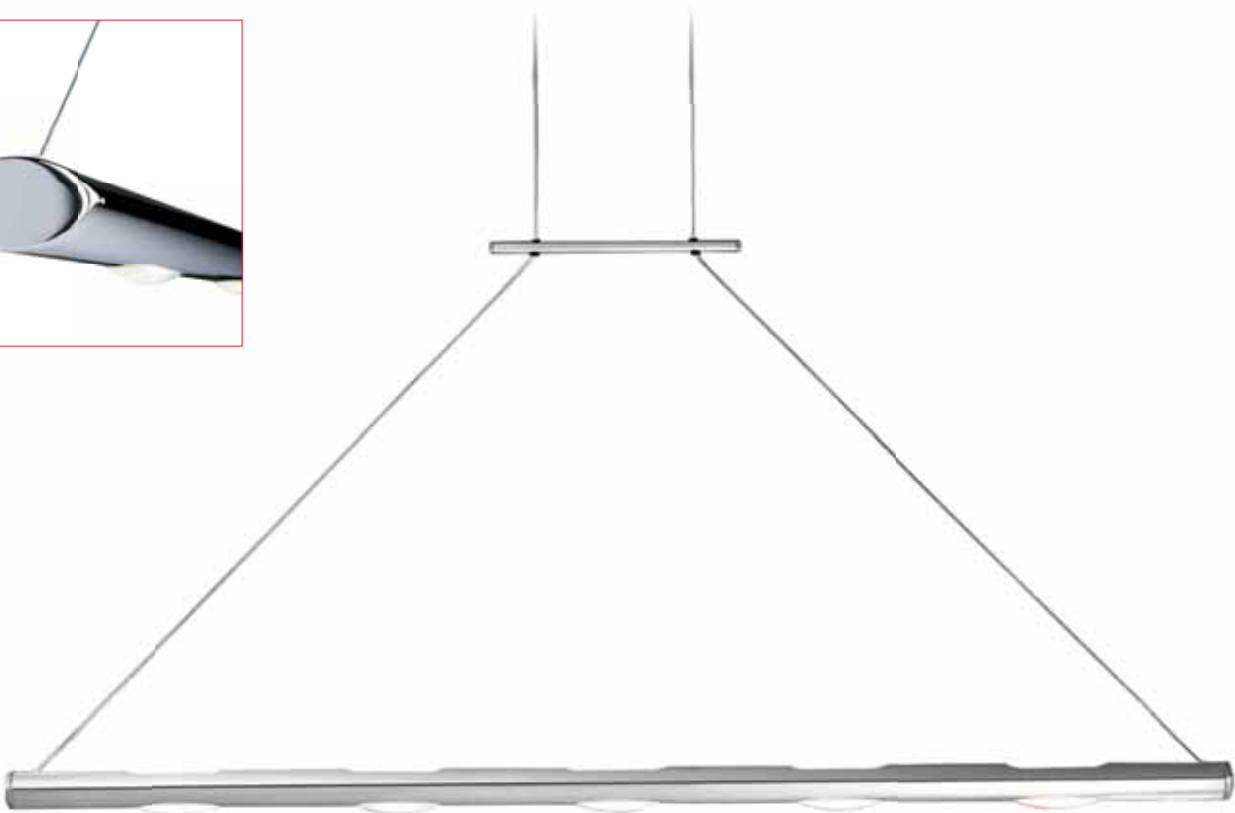

● Cromo  
21 Chrome  
● Chrome  
● Chrom  
● Cromo

● Aluminio pulido y satinado  
S3 Polished and burnished aluminium  
● Aluminium poli et satiné  
● Aluminium poliert und mattglänzend  
● Alluminio lucidato e satinato

○ Cristal anti-deslumbrante  
F1 Anti-glare glass  
● Verre antiéblouissante  
● Blendfreies Glas  
● Vetro antiriflesso

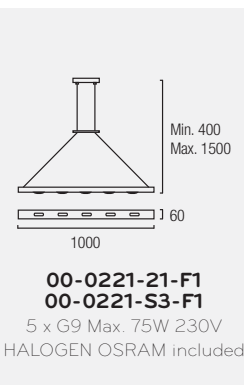



# adagio

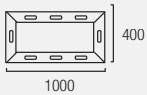

**20-0313-21-F1**  
**20-0313-S3-F1**

8 x G9 Max. 75W 230V  
HALOGEN OSRAM included

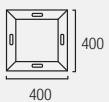
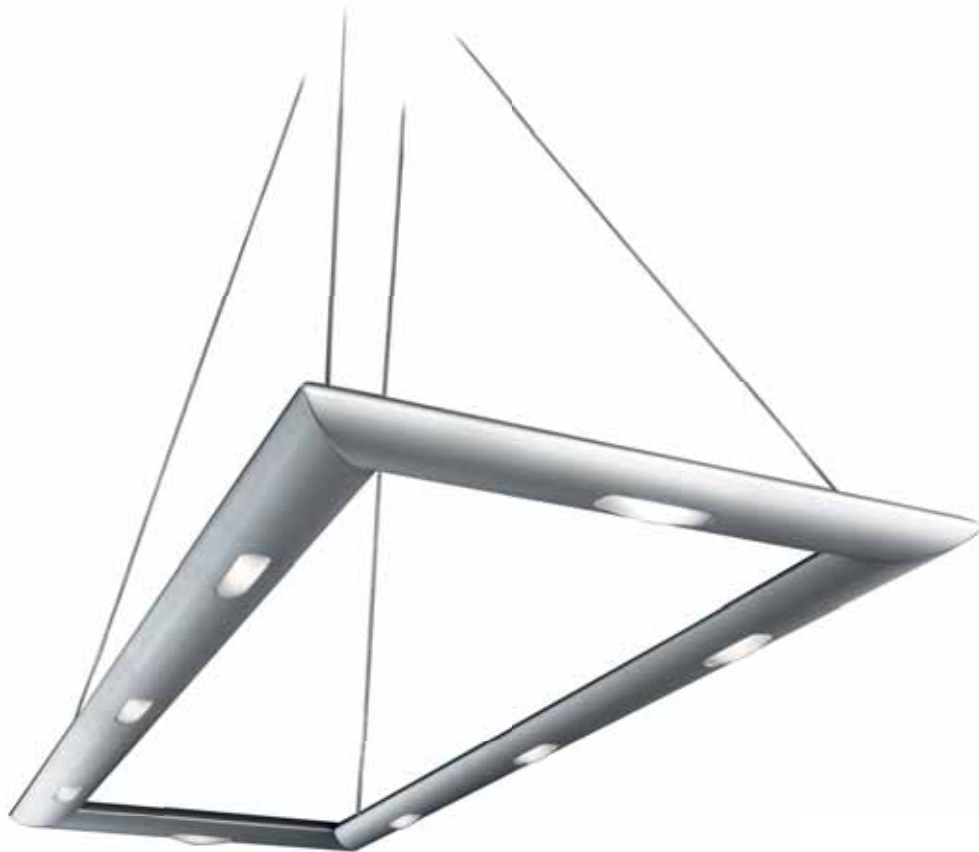

**20-0221-21-F1**  
**20-0221-S3-F1**

4 x G9 Max. 75W 230V  
HALOGEN OSRAM included



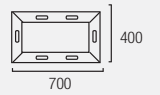

**20-0536-21-F1**  
**20-0536-S3-F1**

6 x G9 Max. 75W 230V  
HALOGEN OSRAM included

# tempo

design \_ Josep Patsí

tempo\_collection

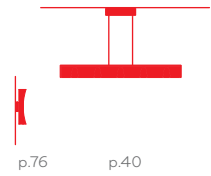

p.76

p.40

Estructura de aluminio disponible en 3 acabados: Ecobright, lacado negro y lacado blanco. Luz directa e indirecta gracias al difusor de metacrilato transparente matizado.

Aluminium body available in 3 finishes: Ecobright, black lacquer or white lacquer. Direct and indirect light thanks to matte and transparent methacrylate diffuser.

Structure en aluminium proposée avec trois finitions: Ecobright, verni noir et verni blanc. Lumière directe et indirecte grâce au diffuseur en méthacrylate teinté transparent.

Gehäuse aus Aluminium, lieferbar in 3 Ausführungen: Ecobright, schwarz lackiert und weiß lackiert. Zur direkten und indirekten Beleuchtung durch Diffusor aus transparentem mattiertem Plexiglas.

Struttura in alluminio, disponibile in 3 finiture: Ecobright, laccato nero e laccato bianco. Luce diretta e indiretta, grazie al diffusore in metacrilato trasparente opacizzato.



Metacrilato transparente matizado  
Transparent sand-blasted methacrylate



○ Aluminium Ecobright  
Ecobright aluminium  
**AH** Aluminium Ecobright  
Ecobright aluminium  
Alluminio Ecobright

● Lacado negro  
Black lacquered  
**05** Laqué en noir  
Schwarz lackiert  
Laccato nero

○ Lacado blanco  
White lacquered  
**78** Laqué en blanc  
Weiss lackiert  
Laccato bianco

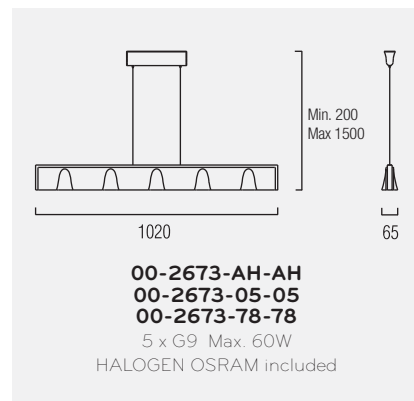





# slimm

design \_ Estudi Ribaudí

slimm\_collection

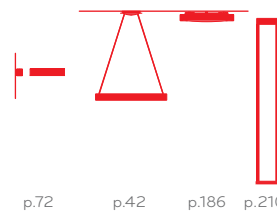

Estructura metálica disponible en acabados cromo y aluminio mate. Difusor de cristal óptico en la parte inferior. Incluye embellecedores de metacrilato en 3 colores intercambiables. Luz directa e indirecta.

Metal body available in chrome or matte aluminium. Optical glass diffuser in lower part. Includes methacrylate trims in 3 interchangeable colours. Direct and indirect light.

Structure métallique proposée avec finitions chromées et en aluminium mat. Diffuseur en verre optique pour la partie inférieure. Inclut des caches en méthacrylate en trois couleurs interchangeables. Lumière directe et indirecte.

Metallgehäuse lieferbar in Chrom und mattem Aluminium. Diffusor aus Optikglas an Unterseite. Mitgeliefert werden austauschbare Plexiglasauflätze in 3 Farben. Zur direkten und indirekten Beleuchtung.

Struttura metallica disponibile con finitura cromata e alluminio opaco. Diffusore in cristallo ottico nella parte inferiore. Comprende elementi decorativi in metacrilato, in 3 colori intercambiabili. Luce diretta e indiretta.



Incluye 3 acrílicos de color intercambiables  
Includes 3 color interchangeable acrylic pieces

		RF 850°C	
FE	GLASS OPT	PMMA	
	Cromo Chrome 21 Chrome Chrom Cromo		
	Cristal óptico Optic glass E9 Verre optique Optisches Glas Vetro ottico		
	Aluminio mate Matt aluminium Y5 Aluminium mat Alluminium matt Alluminio opaco		

**00-2397-Y5-E9**  
**00-2397-21-E9**  
2 x R7s L=118 Max. 150W  
HALOGEN OSRAM included





# oxygen

design \_ Josep Patsí

oxygen\_collection



p.70

p.44

Estructura de aluminio circular acabado Ecobright. Difusores de cristal anti-deslumbrante. Emite luz directa y también indirecta gracias a las aperturas de la parte superior de la estructura.

Circular Ecobright aluminium body. Anti-glare glass diffusers. Provides direct and indirect light thanks to openings at the top of the luminaire.

Structure circulaire en aluminium avec finitions Ecobright. Diffuseurs en verre antireflets. Émet une lumière directe mais aussi indirecte grâce aux ouvertures de la partie supérieure de la structure.

Rundes Gehäuse aus Aluminium, Oberfläche Ecobright. Diffusore aus entspiegeltem Glas. Direkte Beleuchtung sowie indirekte Beleuchtung durch die Öffnungen an der Oberseite der Leuchte.

Struttura in alluminio circolare con finitura Ecobright. Diffusori in cristallo anti-abbagliamento. Emette luce diretta e indiretta, anche grazie alle aperture della parte superiore della struttura.



<b>Aluminio Ecobright</b> Ecobright aluminium Aluminium Ecobright Ecobright aluminium Alluminio Ecobright	<b>Cristal anti-deslumbrante</b> Anti-glare glass Verre antiéblouissante Blendfreies Glas Vetro antiriflesso		

**00-0573-AH-B8**  
6 x G9 Max. 60W 230V  
HALOGEN OSRAM included





# duna

design \_ Álex Sánchez

duna\_collection

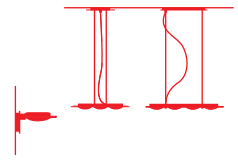

p.82 p.46 p.46

Estructura de aluminio satinado. Difusor de cristal óptico. Disponible en 2 versiones, rectangular y cuadrada. Luz directa e indirecta.

Satin aluminium body. Optical glass diffuser. Available in 2 versions: rectangle and square. Direct and indirect light.

Structure en aluminium satiné. Diffuseur en verre optique. Proposée en deux versions: rectangulaire et carrée.

Gehäuse aus satiniertem Aluminium. Diffusor aus mattem Optikglas. In 2 Ausführungen: rechteckig und quadratisch.

Struttura in alluminio satinato. Diffusore in cristallo ottico. Disponibile in 2 versioni: rettangolare e quadrata.

		RF 850°C
AL	GLASS OPT	
● Aluminio satinado Satin aluminium Aluminium satiné Aluminium matt Alluminio satinato	○ Cristal óptico Optic glass Verre optique Optisches Glas Vetro ottico	

**20-0325-Y6-E9**  
4 x G9 Max. 75W 230V  
HALOGEN OSRAM included

**20-0326-Y6-E9**  
4 x G9 Max. 75W 230V  
HALOGEN OSRAM included

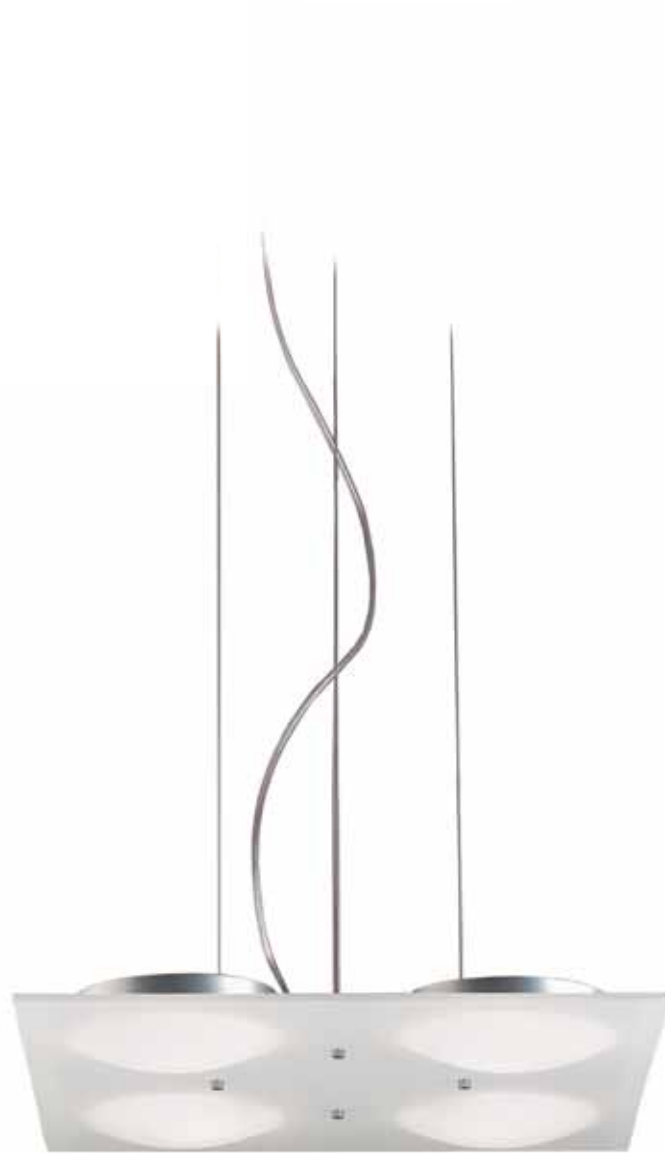



# linear

design \_Benedito Design

Estructura de aluminio acabado pulido satinado. La basculación de la estructura permite elegir la cantidad de luz directa e indirecta deseada.

Metal body finished in satin aluminium. The body's tilt allows you to choose the quantity of direct and indirect light desired.

Structure en aluminium avec finitions polies satinées. L'inclinaison de la structure permet de choisir la quantité désirée de lumière directe et indirecte.

Gehäuse aus Aluminium, glatte satinierte Oberfläche. Das Gehäuse ist kippbar, so dass der gewünschte Grad der direkten und indirekten Beleuchtung reguliert werden kann.

Struttura in alluminio, finitura lucida satinata. La struttura basculante consente di scegliere la quantità di luce diretta e indiretta desiderata.



AL

● Aluminio satinado  
Satin aluminium  
**Y6** Aluminium satiné  
Aluminium matt  
Alluminio satinato

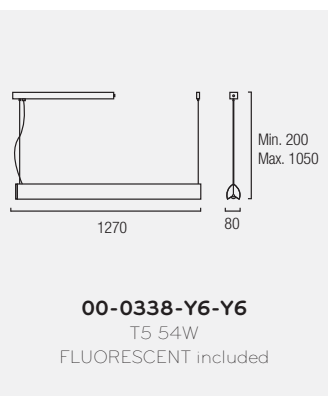



# twins

design \_Benedito Design

Estructura metálica en acabado gris textura. El difusor combina el cristal transparente y el cristal opal triplex. Luz directa.

Metal body in grey textured finish. The diffuser combines transparent glass and triplex opal glass. Direct light.

Structure métallique avec finitions de texture grise. Le diffuseur allie le verre transparent et le verre opal triplex. Lumière directe.

Metallgehäuse mit Oberfläche in grauer Textur. Der Diffusor kombiniert transparentes Glas und Triplex-Opalglas. Direkte Beleuchtung.

Struttura metallica con finitura grigia texture. Il diffusore abbina il cristallo trasparente al cristallo opale triplex. Luce diretta.

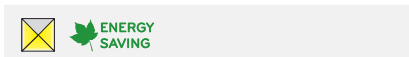
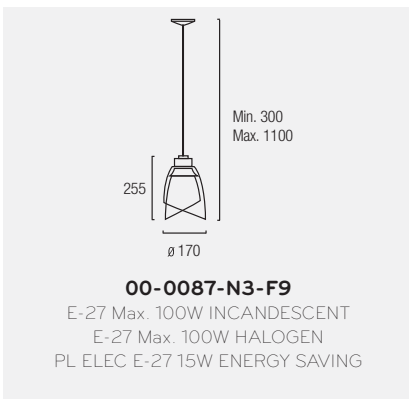

- Gris textura
- Grey texture
- N3** Gris à effet de texture
- Grau rauh-matt
- Grigio rugoso

Cristal transparente y opal triplex  
Transparent and triplex opal glass  
Verre transparent et opal triplex  
Durchsichtigem Glas und triplex-Opalglas  
Cristallo opalino triplex ed trasparente







# swing

design \_ Josep Patsí

Estructura metalizada en acabado gris textura con detalles en cromo. Difusor de cristal óptico. Posibilidad de instalar en techos inclinados. Luz directa e indirecta.

Metal body in grey textured finish with chrome details. Optical glass diffuser. Can be installed on sloping ceilings. Direct and indirect light.

Structure métallisée avec finitions à texture grise avec des détails chromés. Diffuseur en verre optique. Installation sur toits inclinés possible. Lumière directe et indirecte.

Metallgehäuse mit Oberfläche in grauer Textur mit verchromten Details. Diffusor aus mattem Optikglas. Zur Befestigung an Dachschrägen geeignet. Zur direkten und indirekten Beleuchtung.

Struttura metallizzata con finitura grigia texture, con finiture cromate. Diffusore in cristallo ottico. Possibilità di installazione su soffitti inclinati. Luce diretta e indiretta.

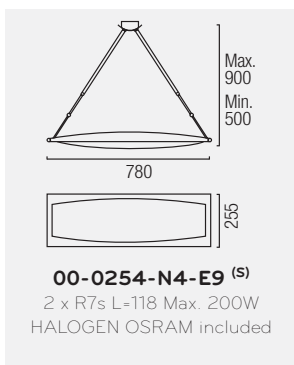

	Gris textura con cromo Grey texture with chrome	
<b>N4</b>	Gris à effet de texture avec chrome Grau rauh-matt mit Chrom Grigio rugoso con cromo	
	Cristal óptico Optic glass	
<b>E9</b>	Verre optique Optishes Glas Vetro ottico	



# otras referencias / other references

LOMA es una colección del catálogo ARCHITECTURAL de LEDS-C4

LOMA is an ARCHITECTURAL catalogue series (LEDS-C4)



## LOMA

**Sistema de fluorescencia lineal preparada para conexión de dispositivos.**  
*Fluorescent lineal lighting system suitable for optional devices*

**Loma es algo más que una luminaria. Su arquitectura modular y su diseño permiten la incorporación de una variada gama de dispositivos. Equipada con lámparas T5 (39W-54W-80W) que proporcionan luz directa e indirecta para lograr un mayor confort lumínico.**

*LOMA is more than a luminaire. Its modular architecture and its design give the possibility to incorporate a wide variety of devices. The modules are equipped with fluorescent tubes T5 (39-54-80W) that provide excellent luminous comfort through direct/indirect light emission.*

SP-1801-N3-B9 TL5 G5 3x39W (1022 x 214 x max.2200 cm)  
SP-1802-N3-B9 TL5 G5 3x54W (1322 x 214 x max.2200 cm)  
SP-1803-N3-B9 TL5 G5 3x80W (1622 x 214 x max.2200 cm)  
SP-1805-N3-B9 TL5 G5 3x39W (1010 x 214 x max.2200 cm)  
SP-1806-N3-B9 TL5 G5 3x54W (1310 x 214 x max.2200 cm)  
SP-1807-N3-B9 TL5 G5 3x80W (1610 x 214 x max.2200 cm)







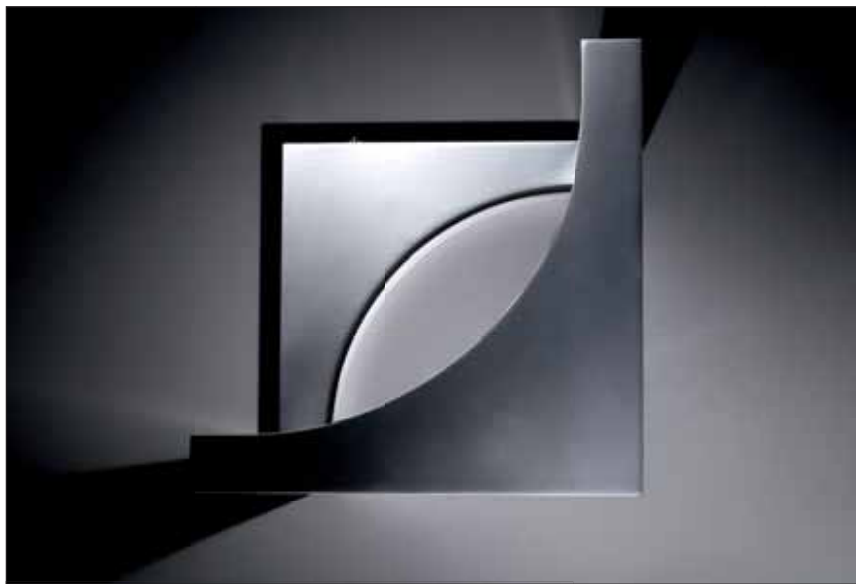

\_apliques  
\_wall fixtures  
\_appliques  
\_wandleuchten  
\_lampade da parete

traç\_56  
troppo\_60  
escher\_62  
arc\_66  
adagio\_68  
oxygen\_70  
level\_71  
slimm\_72  
flat\_74  
tempo\_76  
boomerang\_78  
ciao\_80  
duna\_82  
class\_84  
mirror\_86  
open\_90  
suite\_92  
leila\_96  
hotels\_98  
versatil\_100  
dolce\_102  
ola\_103  
scala\_104



Estructura de aluminio Ecobright y reflector metálico disponible en 2 acabados, blanco y pan de plata. Luz principalmente indirecta y en parte directa gracias al difusor de cristal anti-deslumbrante.

Ecobright aluminium body and metal reflector available in 2 finishes: white and silver leaf. Mainly indirect light and some direct light thanks to an anti-glare glass diffuser.

Structure en aluminium Ecobright et réflecteur métallique proposés avec deux finitions (en blanc et en argenté). Lumière principalement indirecte, partiellement directe à travers son diffuseur en verre antireflets.

Gehäuse aus Ecobright-Aluminium und Metallreflektor, lieferbar in 2 Ausführungen: Weiß und Silberfolie. Direkte Beleuchtung und auch indirekte Beleuchtung durch Diffusor aus entspiegeltem Glas.

Struttura in alluminio Ecobright e riflettore metallico disponibile in due finiture, bianco e foglia d'argento. Luce principalmente indiretta e parzialmente diretta, grazie al diffusore in cristallo anti-abbagliamento.



- |  |   |
|--|---|
| ○ Blanco<br>White<br><b>AH</b><br>Blanc<br>Weiss<br>Bianco | ● Pan de plata<br>Silver leaf<br><b>D9</b><br>Feuille d'argent<br>Blattsilber<br>Foglia argento |
|--|---|

- Cristal anti-deslumbrante  
Anti-glare glass  
**F1**  
Verre antiéblouissant  
Blendfreies Glas  
Vetro antiriflesso

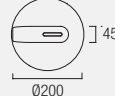
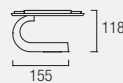

**05-2870-AH-F1**  
**05-2870-D9-F1**

G9 Max. 75W  
HALOGEN OSRAM included









# tropo

design\_ Benedito Design

tropo\_collection

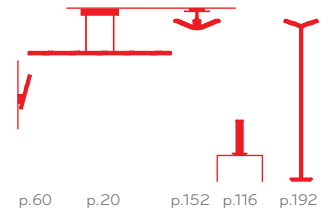

Estructura de aluminio acabado en cromo. Cristales de borosilicato matizado. Elegante combinación de formas simples: línea y círculo. Emite luz directa y también indirecta gracias a las aperturas de la parte posterior de la estructura.

Aluminium body finished in chrome. Matte borosilicate glass. Elegant combination of simple shapes - lines and circles. Provides direct and indirect light thanks to openings on the back of the luminaire.

Structure en aluminium avec finitions chromées. Verre borosilicate teinté. Combinaison élégante de formes simples telles que des lignes et des cercles. Émet une lumière directe mais aussi indirecte grâce aux ouvertures de la partie postérieure de la structure.

Wandleuchte Gehäuse aus verchromtem Aluminium. Mattes Borsilikatglas. Elegante Kombination einfacher Formen: Linie und Kreis. Direkte Beleuchtung sowie indirekte Beleuchtung durch die Öffnungen an der Rückseite der Leuchte.

Struttura in alluminio con finitura cromata. Cristalli di borosilicato opacizzato. Elegante accostamento di forme semplici: linee e cerchi. Emette luce diretta e indiretta, anche grazie alle aperture nella parte posteriore della struttura.



● Cromo  
● Chrome  
**21** Chrome  
● Chrom  
● Cromo

○ Cristal anti-deslumbrante  
○ Anti-glare glass  
**F1** Verre antiéblouissante  
○ Blendfreies Glas  
○ Vetro antiriflesso

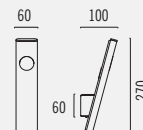

**05-2804-21-F1**

G9 75W

HALOGEN OSRAM included





# escher

design \_ Josep Patsí

escher\_collection

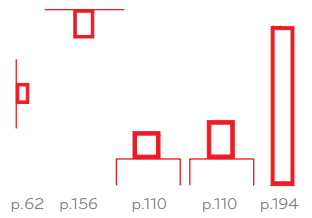

Estructura metálica en 3 acabados disponibles: aluminio Ecobright, lacado blanco y lacado negro. Luz indirecta.

Metal body available in 3 finishes: Ecobright, black lacquer or white lacquer. Indirect light.

Structure métallique proposée avec trois finitions : aluminium Ecobright, verni blanc et verni noir. Lumière indirecte.

Metallgehäuse in 3 Ausführungen lieferbar: Ecobright-Aluminium, weiß lackiert und schwarz lackiert. Indirekte Beleuchtung.

Struttura metallica disponibile con 3 finiture: alluminio Ecobright, laccato bianco e laccato nero. Luce indiretta.

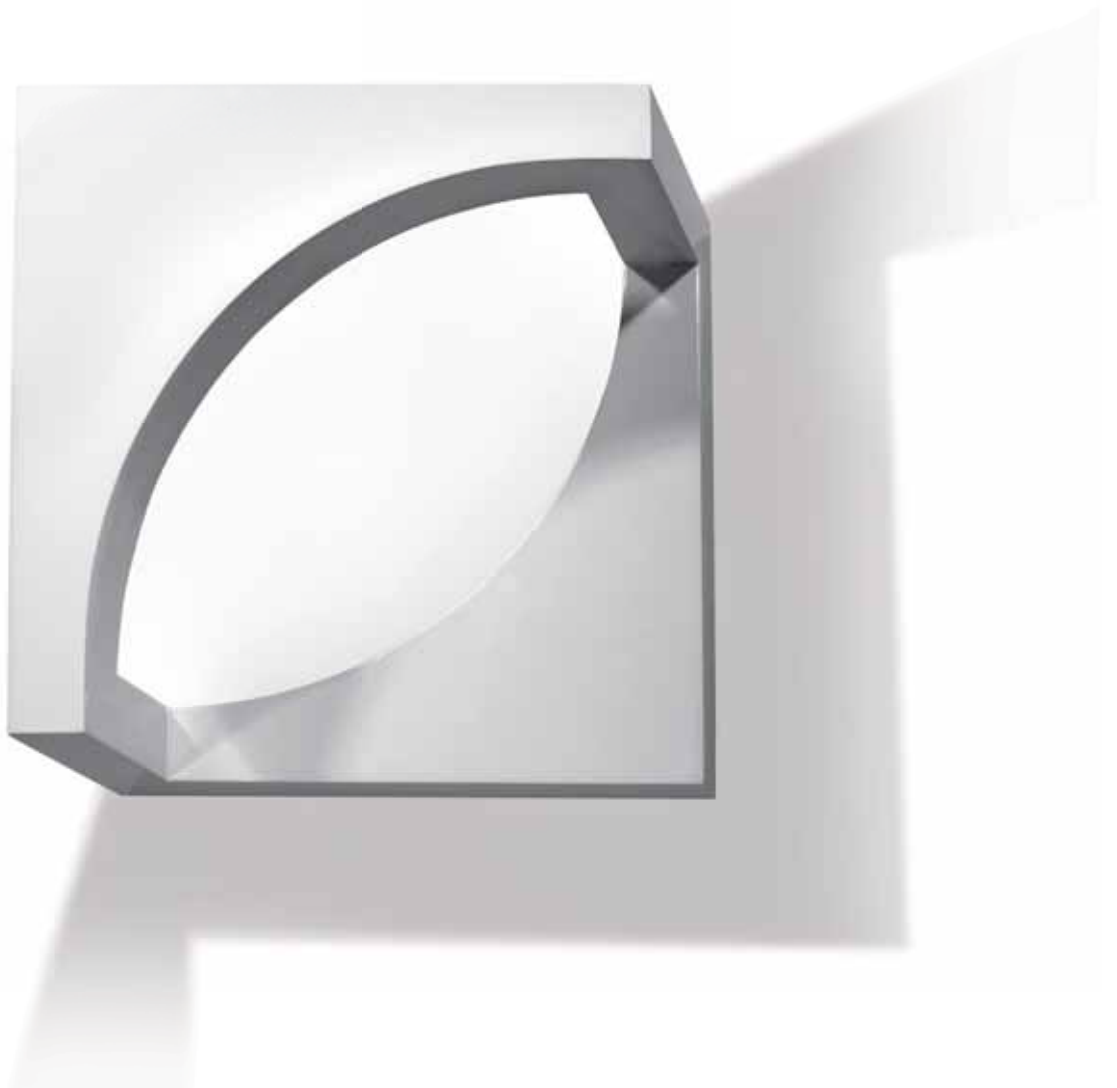

FE

● Aluminio Ecobright  
Ecobright aluminium  
**AH** Aluminium Ecobright  
Ecobright aluminium  
Alluminio Ecobright

● Lacado negro  
Black lacquered  
**05** Laqué en noir  
Schwarz lackiert  
Laccato nero

○ Lacado blanco  
White lacquered  
**78** Laqué en blanc  
Weiss lackiert  
Laccato bianco

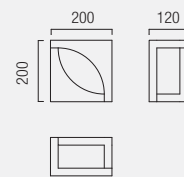

**05-2782-AH-AH**  
**05-2782-05-05**  
**05-2782-78-78**

2 x G9 75W

HALOGEN OSRAM included









# arc

design \_ Estudi Ribaudí

arc\_collection

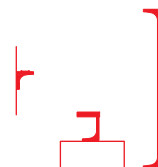

p.66 p.114 p.206

Estructura de aluminio y difusor de metacrilato. Disponible en 3 acabados: aluminio Ecobright, lacado blanco y lacado negro. Luz indirecta.

Aluminium body and methacrylate diffuser. Available in 3 finishes: Ecobright aluminium, black lacquer or white lacquer. Indirect light.

Applique Structure en aluminium et diffuseur en méthacrylate. Proposée avec trois finitions: aluminium Ecobright, verni blanc et verni noir. Lumière indirecte.

Gehäuse aus Aluminium und Diffusor aus Plexiglas. In 3 Ausführungen lieferbar: Ecobright-Aluminium, weiß lackiert und schwarz lackiert. Indirekte Beleuchtung.

Struttura in alluminio e diffusore in metacrilato. Disponibile in 3 finiture: alluminio Ecobright, laccato bianco e laccato nero. Luce indiretta.



AL PMMA

● Aluminium Ecobright  
Ecobright aluminium  
**AH** Aluminium Ecobright  
Ecobright aluminium  
Alluminio Ecobright

● Lacado negro  
Black lacquered  
**05** Laqué en noir  
Schwarz lackiert  
Laccato nero

○ Lacado blanco  
White lacquered  
**78** Laqué en blanc  
Weiss lackiert  
Laccato bianco

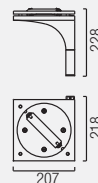

**05-2580-AH-AH**  
**05-2580-05-05**  
**05-2580-78-78**

R7s L=118 Max 150W  
HALOGEN OSRAM included



# adagio

design \_ Josep Patsí

adagio\_collection

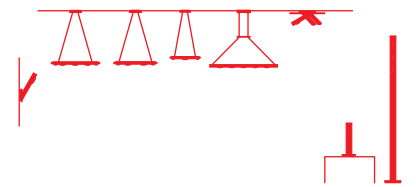

p.68 p.38 p.39 p.38 p.36 p.166 p.118 p.209

Estructura de aluminio y difusores de cristal anti-deslumbrante. Disponible en acabados cromo y aluminio pulido satinado. Emite luz directa y también indirecta gracias a las aperturas de la parte posterior de la estructura.

Aluminium body and anti-glare glass diffusers. Available in chrome or polished and satin aluminium. Provides direct and indirect light thanks to openings on the back of the luminaire.

Structure en aluminium et diffuseurs en verre anti-reflets. Proposée avec des finitions chromées et en aluminium poli satiné. Émet une lumière directe mais aussi indirecte grâce aux ouvertures de la partie postérieure de la structure.

Gehäuse aus Aluminium und Diffusore aus entspiegeltem Glas. Verchromt und in poliertem satinier-tem Aluminium lieferbar. Direkte Beleuchtung sowie indirekte Beleuchtung durch die Öffnungen an der Rückseite der Leuchte.

Struttura in alluminio e diffusori in cristallo anti-abbagliamento. Disponibile con finitura in cromo e alluminio lucido satinato. Emette luce diretta e indiretta, anche grazie alle aperture nella parte posteriore della struttura.



● Cromo  
● Chrome  
● Chrom  
● Cromo

**21**

● Aluminio pulido y satinado  
● Polished and burnished aluminium  
● Aluminium poli et satiné  
● Aluminium poliert und mattglänzend  
● Alluminio lucidato e satinato

**S3**

○ Cristal anti-deslumbrante  
○ Anti-glare glass  
○ Verre antiéblouissante  
○ Blendfreies Glas  
○ Vetro antiriflesso

**F1**

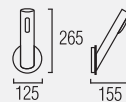

**05-0221-21-F1**

**05-0221-S3-F1**

G9 Max. 75W 230V

HALOGEN OSRAM included

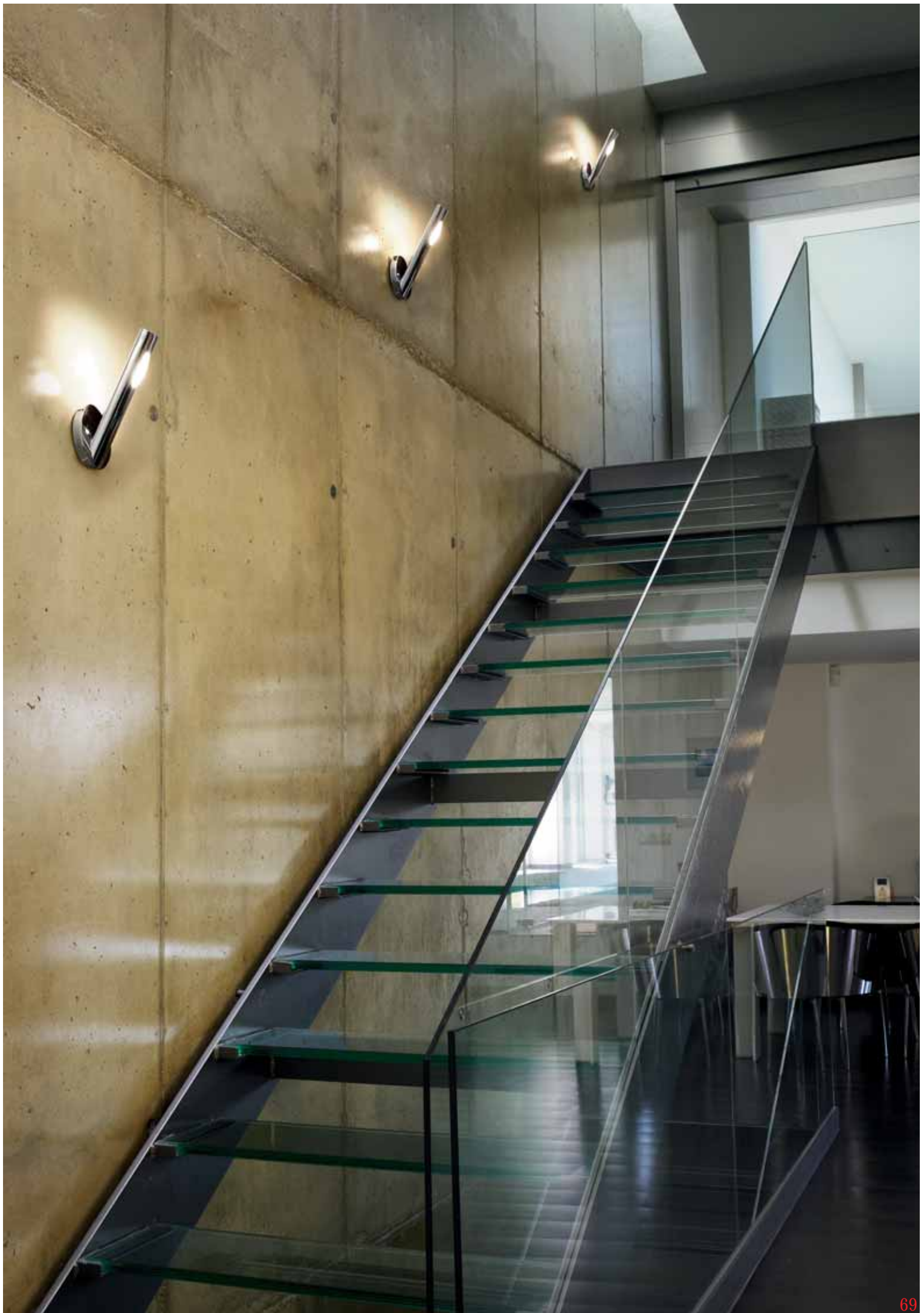



# oxygen

design \_ Josep Patsí

oxygen\_collection



p.70

p.44

Estructura de aluminio semi-circular, acabado Ecobright. Difusores de cristal anti-deslumbrante. Luz indirecta.

Circular Ecobright aluminium body. Anti-glare glass diffusers. Indirect light.

Structure semi-circulaire en aluminium avec finitions Ecobright. Diffuseurs en verre antireflets. Lumière indirecte.

Halbrundes Gehäuse aus Aluminium, Oberfläche Ecobright. Diffusoren aus entspiegeltem Glas. Direktes und indirektes Licht.

Struttura in alluminio semicircolare, con finitura Ecobright. Diffusori in cristallo anti-abbagliamento. Luce diretta e indiretta.

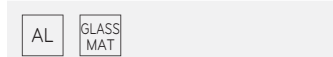
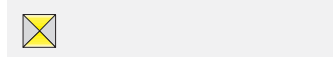
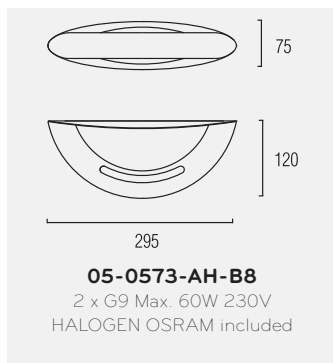

● Aluminio Ecobright  
Ecobright aluminium  
**AH** Aluminium Ecobright  
Ecobright aluminium  
Alluminio Ecobright

○ Cristal anti-deslumbrante  
Anti-glare glass  
**B8** Verre antiéblouissante  
Blendfreies Glas  
Vetro antiriflesso



Estructura metálica que combina los acabados cromo y gris textura. Cristal óptico matizado. Luz indirecta.

Metal body that combines in chrome and grey textured finishes. Matte optical glass. Indirect light.

Structure métallique qui associe des finitions chromées et une texture grise. Verre optique teinté. Lumière indirecte.

Metallgehäuse mit Oberfläche aus Chrom und grauer Textur. Mattiertes Optikglas. Indirekte Beleuchtung.

Struttura metallica che abbina finiture cromate e grigio texture. Cristallo ottico opacizzato. Luce indiretta.

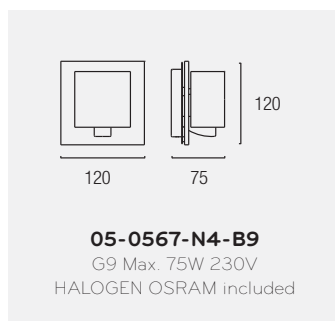

Gris textura con cromo  
 Grey texture with chrome  
**N4** Gris à effet de texture avec chrome  
 Grau rauh-matt mit Chrom  
 Grigio rugoso con cromo

Cristal óptico  
 Optic glass  
**B9** Verre optique  
 Optishes Glas  
 Vetro ottico



# slimm

design \_ Estudi Ribaudí

slimm\_collection

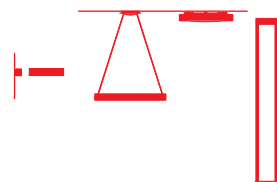

p.72 p.42 p.186 p.210

Estructura metálica disponible en acabados cromo y aluminio mate. Difusor de cristal óptico en la parte inferior. Incluye embellecedores de metacrilato en 3 colores intercambiables. Luz emitida hacia arriba y hacia abajo.

Metal body available in chrome or matte aluminium. Optical glass diffuser in lower part. Includes methacrylate trims in 3 interchangeable colours. Lighting diffused up and down.

Structure métallique proposée avec finitions chromées et en aluminium mat. Diffuseur en verre optique pour la partie inférieure. Inclut des caches en méthacrylate en trois couleurs interchangeables. Lumière émise vers le haut et vers le bas.

Metallgehäuse lieferbar in Chrom und mattem Aluminium. Diffusor aus Optikglas an Unterseite. Mitgeliefert werden austauschbare Plexiglasauflätze in 3 Farben. Lichtstrahl nach oben und nach unten.

Struttura metallica disponibile con finitura cromata e alluminio opaco. Diffusore in cristallo ottico nella parte inferiore. Comprende elementi decorativi in metacrilato, in 3 colori intercambiabili. Flusso di luce emesso verso l'alto e verso il basso.



- Cromo  
● Chrome  
**21** Chrome  
● Chrom  
● Cromo
- Aluminio mate  
● Matt aluminium  
**Y5** Aluminium mat  
● Alluminium matt  
● Alluminio opaco

- Cristal óptico  
○ Optic glass  
**E9** Verre optique  
○ Optishes Glas  
○ Vetro ottico



**05-2397-Y5-E9**  
**05-2397-21-E9**

R7s L=118 Max. 150W  
HALOGEN OSRAM included



Incluye 3 acrílicos de color intercambiables  
Includes 3 color interchangeable acrylic pieces

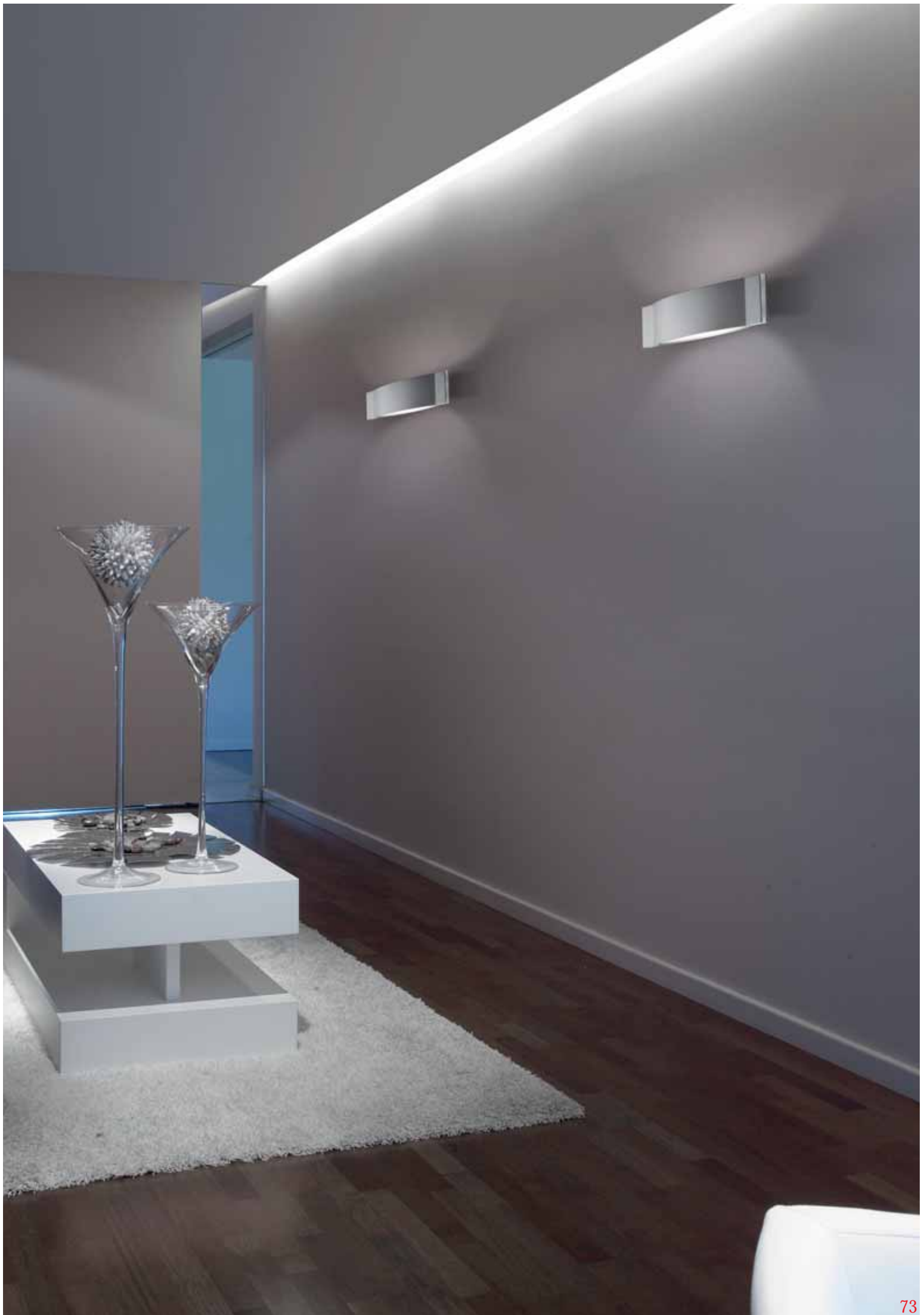



Estructura metálica en acabado níquel satinado. Difusor de cristal óptico matizado. Disponible en 3 tamaños distintos: 18 cm de ancho sólo para halógeno y 25 y 40 cm de ancho para halógeno o fluorescente. Luz directa e indirecta.

Satin nickel metal body. Matte optical glass diffuser. Available in 3 different sizes: 18 cm for halogen lamps only and 25 and 40 cm for halogen and fluorescent lamps. Direct and indirect light.

Structure métallique avec finitions en nickel satiné. Diffuseur en verre optique teinté. Proposée en trois tailles: largeur de 18 cm de large (seulement pour l'halogène) et largeur de 25 et 40 cm pour la version fluoescence. Lumière directe et indirecte.

Metallgehäuse in satinier-tem Nickel. Diffusor aus mattem Optikglas. In 3 Größen lieferbar: 18 cm breit nur für Halogenlam- pen und 25 und 40 cm breit Für Halogen- und fluoesczierende Lampen. Zur direkten und indirekten Beleuchtung.

Struttura metallica con finitura nichel satinato. Diffusore in cristallo ottico opacizzato. Disponibile in 3 diverse misure: 18 cm di larghezza, solo per alogene e 25 e 40 cm di larghez- za per alogene e lampade fluoescenti. Luce diretta e indiretta.

**05-0570-81-B9**  
R7s L=78 Max. 100W  
HALOGEN OSRAM included

**05-0571-81-B9**  
R7s L=118 Max. 150W  
HALOGEN OSRAM included

**05-2366-81-B9**  
G24d-2 18W  
ENERGY SAVING

**05-0572-81-B9**  
2 x R7s L=118 Max. 150W  
HALOGEN OSRAM included

**05-2367-81-B9**  
2 x G24d-2 18W  
ENERGY SAVING



**ENERGY SAVING**

**81** Níquel Satinado  
Satin nickel  
Nickel satiné  
Nickel matt  
Nichel satinato

**B9** Cristal óptico  
Optic glass  
Verre optique  
Optishes Glas  
Vetro ottico





# tempo

design \_ Josep Patsí

tempo\_collection

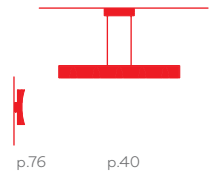

Estructura de aluminio disponible en 3 acabados: Ecobright, lacado negro y lacado blanco. Luz directa e indirecta gracias al difusor de cristal óptico matizado.

Aluminium body available in 3 finishes: Ecobright, black lacquer or white lacquer. Direct and indirect light thanks to matte optical glass diffuser.

Structure en aluminium proposée avec trois finitions : Ecobright, verni noir et verni blanc. Lumière directe et indirecte grâce au diffuseur en verre optique teinté.

Gehäuse aus Aluminium, lieferbar in 3 Ausführungen: Ecobright, schwarz lackiert und weiß lackiert. Zur direkten und indirekten Beleuchtung durch Diffusor aus mattiertem Optikglas.

Struttura in alluminio, disponibile in 3 finiture: Ecobright, laccato nero e laccato bianco. Luce diretta e indiretta, grazie al diffusore in cristallo ottico opacizzato.



<b>AH</b> Aluminium Ecobright Ecobright aluminium Aluminium Ecobright Ecobright aluminium Alluminio Ecobright	<b>05</b> Lacado negro Black lacquered Laqué en noir Schwarz lackiert Laccato nero	<b>78</b> Lacado blanco White lacquered Laqué en blanc Weiss lackiert Laccato bianco	

**05-2673-AH-AH (S)**  
**05-2673-05-05 (S)**  
**05-2673-78-78 (S)**  
 2 x G9 75W  
 HALOGEN OSRAM included



# boomerang

design \_ Josep Patsí

boomerang\_collection



Estructura metálica en acabado níquel satinado. Difusor de cristal óptico matizado. Disponible en versión halógena (20cm ancho) y en versión fluorescente (25cm ancho). Luz directa.

Satin nickel metal body. Matte optical glass diffuser. Available in halogen version (20 cm) and fluorescent version (25 cm). Direct light.

Structure métallique avec finitions en nickel satiné. Diffuseur en verre optique teinté. Proposée en halogène (20 cm de largeur) et en version fluorescente (25 cm de largeur). Lumière directe.

Metallgehäuse in satinier-tem Nickel. Diffusor aus mattem Optikglas. Lieferbar für Halogenlampen (20cm breit) und für fluoreszierende Lampen (25 cm breit). Direkte Beleuchtung.

Struttura metallica con finitura nichel satinato. Diffusore in cristallo ottico opacizzato. Disponibile in versione alogena (larghezza 20 cm) e fluorescente (larghezza 25 cm). Luce diretta.



● Níquel Satinado  
Satin nickel  
**81** Nickel satiné  
Nickel matt  
Nichel satinato

○ Cristal óptico  
Optic glass  
**B4** Verre optique  
Optisches Glas  
Vetro ottico



**05-2573-81-B4**

G24d2 18W  
ENERGY SAVING

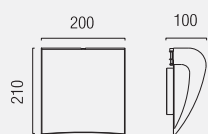

**05-2572-81-B4**

R7s L=118 Max. 150W  
HALOGEN OSRAM included





# ciao

design \_ Josep Patsí

Estructura metálica en acabado cromo. Difusor de cristal óptico matizado. Luz directa.

Chrome metal body. Matte optical glass diffuser. Direct light.

Structure métallique avec finitions chromées. Diffuseur en verre optique teinté. Lumière directe.

Gehäuse aus verchromtem Metall. Diffusor aus mattem Optikglas. Direkte Beleuchtung.

applique Struttura metallica con finitura cromata. Diffusore in cristallo ottico opacizzato. Luce diretta.

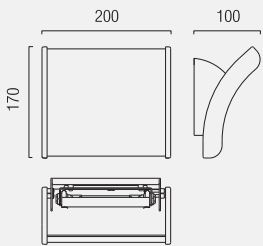

**05-2574-21-B4**

R7s L=118 Max. 150W

HALOGEN OSRAM included



● Cromo  
● Chrome  
**21** Chrome  
● Chrom  
● Cromo

○ Cristal óptico  
○ Optic glass  
**B4** Verre optique  
○ Optishes Glas  
○ Vetro ottico



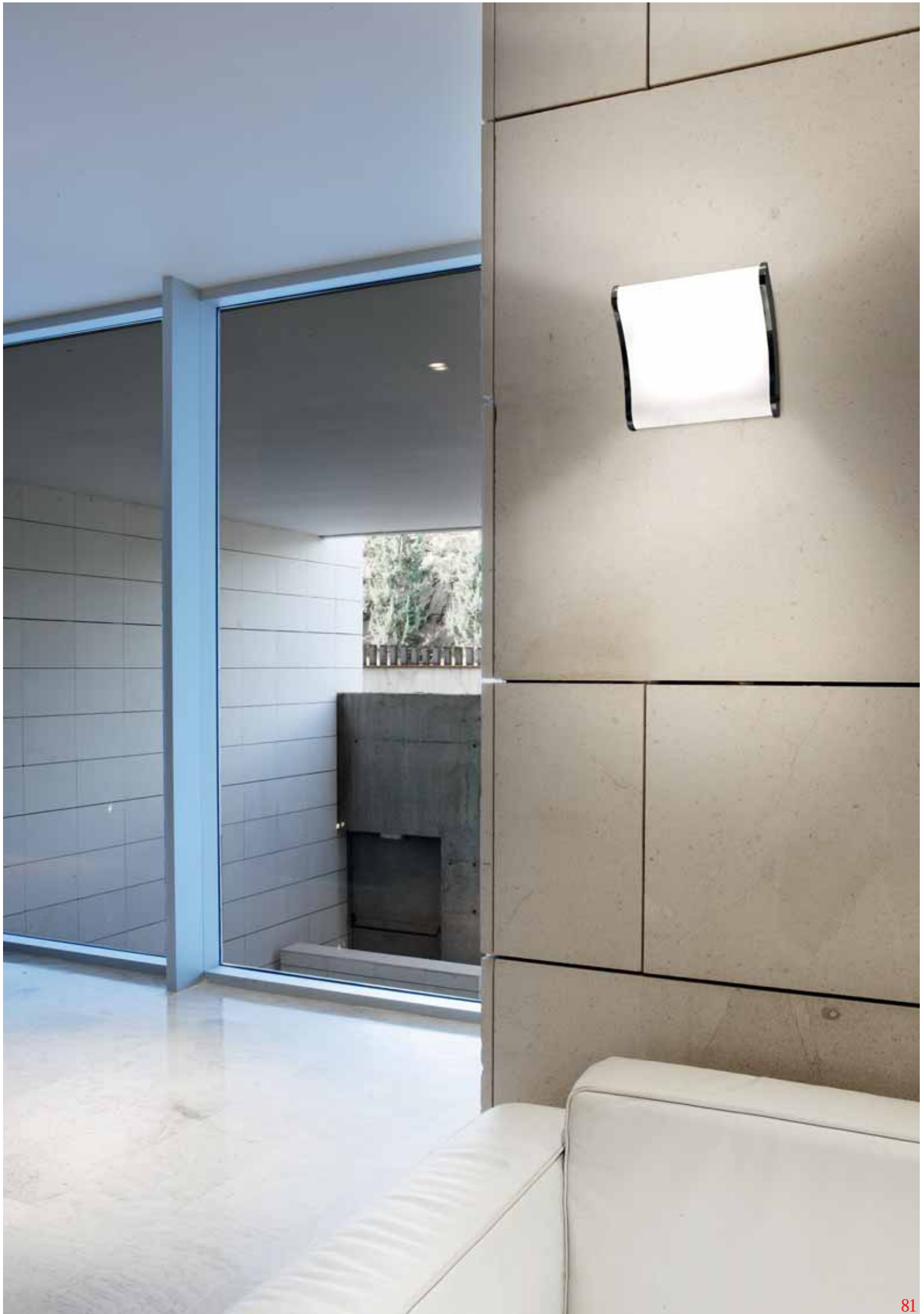

# duna

design \_ Álex Sánchez

duna\_collection

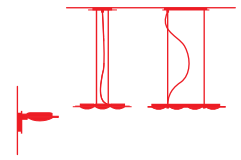

p.82 p.46 p.46

Estructura de aluminio satinado. Difusor de cristal óptico. Luz emitida hacia arriba y hacia abajo.

Satin aluminium body. Optical glass diffuser. Lighting diffused up and down.

Structure en aluminium satiné. Diffuseur en verre optique. Lumière émise vers le haut et vers le bas.

Gehäuse aus satiniertem Aluminium. Diffusor aus mattedem Optikglas. Lichtstrahl nach oben und nach unten.

Struttura in alluminio satinato. Diffusore in cristallo ottico. Flusso di luce emesso verso l'alto e verso il basso.

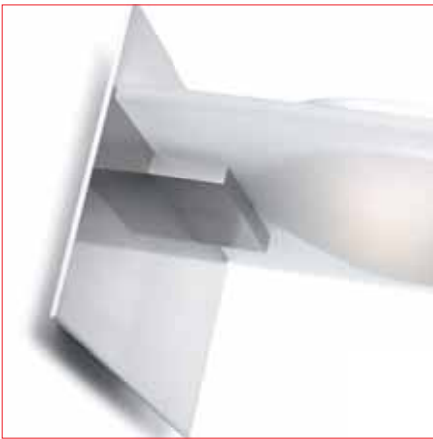

● Níquel Satinado  
Satin nickel  
**81** Nickel satiné  
Nickel matt  
Nichel satinato

○ Cristal óptico  
Optic glass  
**E9** Verre optique  
Optishes Glas  
Vetro ottico

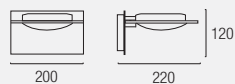

**05-0325-81-E9**  
G9 Max. 75W 230V  
HALOGEN OSRAM included



# class

design \_ Josep Patsi

class\_collection

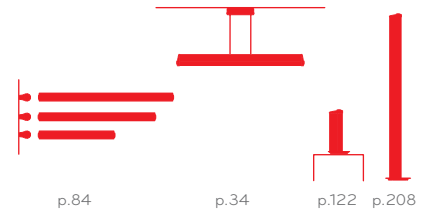

Estructura de aluminio Ecobright. Doble difusor: interior de policarbonato opal y exterior de borosilicato transparente. Luz directa. Disponible en 3 tamaños. Luz directa. Apto para baño (IP44).

Double diffuser - inner: opal polycarbonate, exterior: transparent borosilicate Direct light. Available in 3 sizes. Direct light. Suitable for bathrooms (IP44).

Double diffuseur: intérieur en polycarbonate opale et extérieur en borosilicate transparent. Lumière directe. Proposée en trois largeurs. Lumière directe. Convient à un usage en salle de bain (IP44).

Diffusor: Innen aus Opal-Polykarbonat und außen aus transparentem Borosilikat. Direkte Beleuchtung. In 3 Größen lieferbar. Geeignet für Badezimmer (IP44).

Doppio diffusore: interno in policarbonato opale ed esterno in borosilicato trasparente. Luce diretta. Disponibile in 3 misure. Luce diretta. Adatto per il bagno (IP44).



Doble difusor  
Double diffuser  
Diffuseur double  
Doppelglas  
Difusore doppio

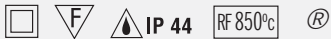

● Aluminio Ecobright  
Ecobright aluminium  
**AH** Aluminium Ecobright  
Ecobright aluminium  
Alluminio Ecobright

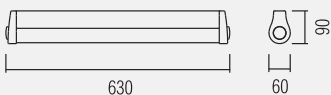

**05-2694-AH-37 (S)**

T5 24W FLUORESCENT included

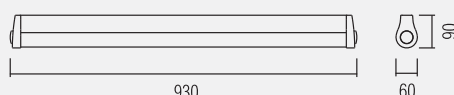

**05-2695-AH-37 (S)**

T5 39W FLUORESCENT included

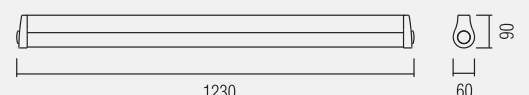

**05-2696-AH-37 (S)**

T5 54W FLUORESCENT included





# mirror

design \_ Josep Patsí

mirror\_collection



Estructura de aluminio satinado. Difusor de policarbonato opal. Disponible en 3 tamaños: 60cm, 90cm y 120cm de ancho. Luz directa. Apto para baño (IP44).

Satin aluminium body. Opal polycarbonate diffuser. Available in 3 sizes: 60cm, 90cm and 120cm. Direct light. Suitable for bathrooms (IP44).

Structure en aluminium satiné. Diffuseur en polycarbonate opale. Proposée en trois largeurs: 60 cm, 90 cm et 120 cm. Lumière directe. Convient à un usage en salle de bain (IP44).

Gehäuse aus satiniertem Aluminium. Diffusor aus Opal-Polykarbonat. In 3 Größen lieferbar: 60cm, 90cm und 120cm breit. Direkte Beleuchtung. Geeignet für Badezimmer (IP44).

Struttura in alluminio satinato. Diffusore in policarbonato opale. Disponibile in 3 misure: larghezza 60 cm, 90 cm e 120 cm. Luce diretta. Adatto per il bagno (IP44).



**Y6**  Aluminio satinado  
Satin aluminium  
Aluminium satiné  
Aluminium matt  
Alluminio satinato

**M1**  Difusor policarbonato opal  
Opal polycarbonate diffuser  
Diffuseur polycarbonate opale  
Polykarbonatdiffusor Opal  
Diffusore in policarbonato opalino

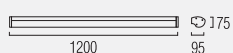

**05-0267-Y6-M1**  
T5 54W  
FLUORESCENT  
included

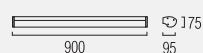

**05-0266-Y6-M1**  
T5 39W  
FLUORESCENT  
included



**05-0265-Y6-M1**  
T5 24W  
FLUORESCENT  
included

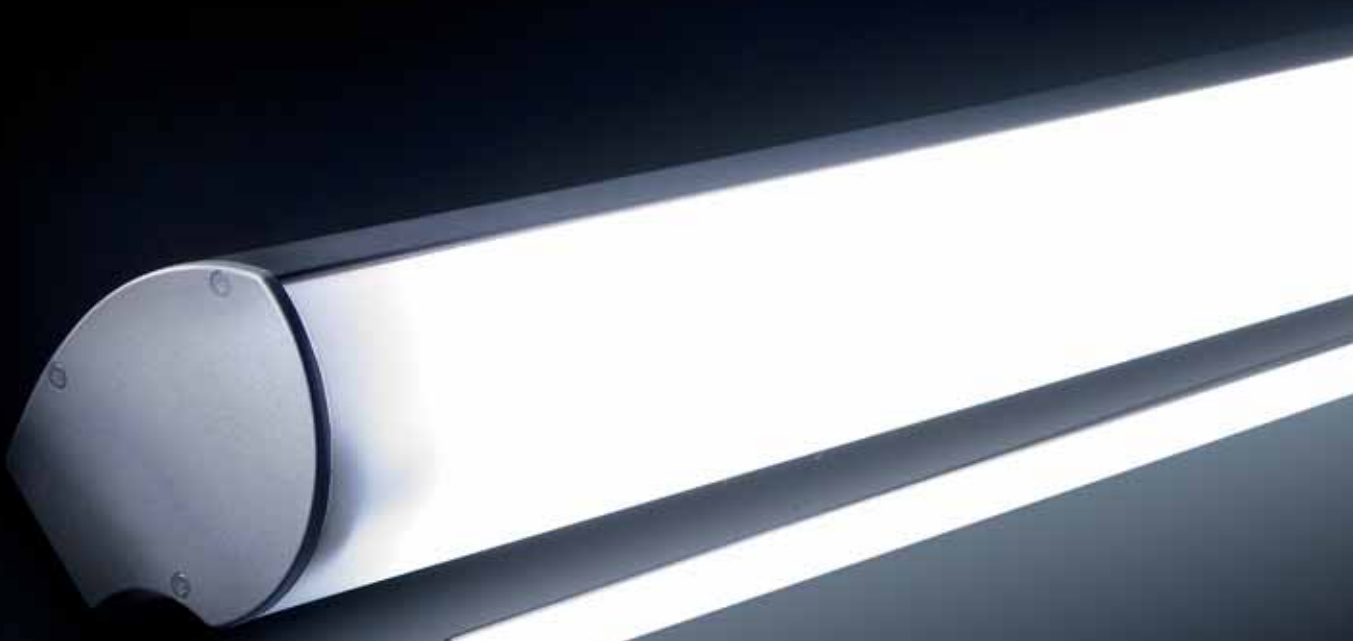

mirror



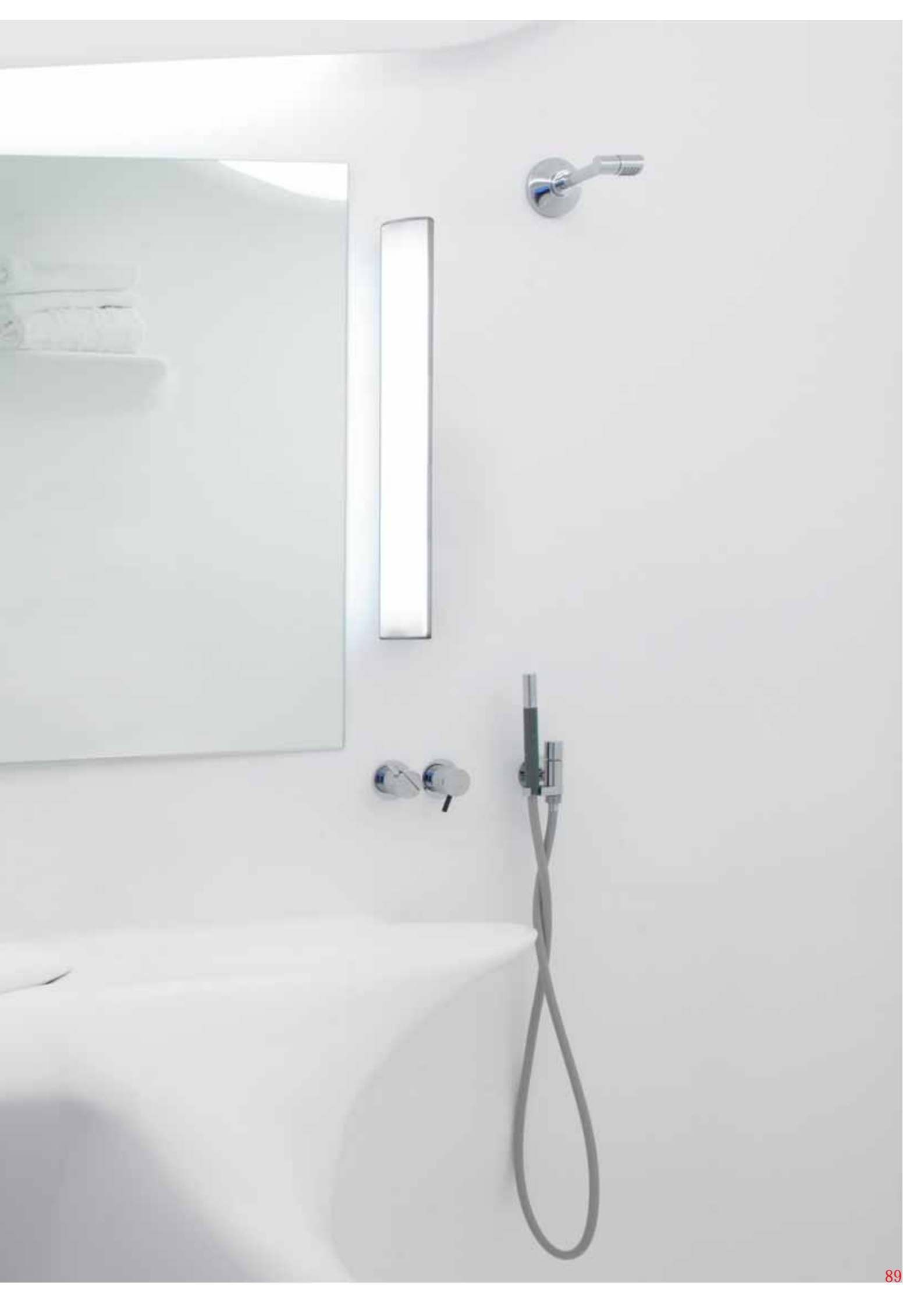

# open

design \_ Josep Patsí

open\_collection

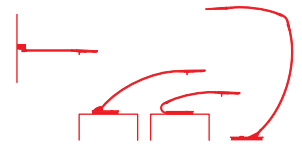

p.90 p.136 p.136 p.220

Estructura metálica en acabados aluminio Ecobright y cromo. Interruptor incluido. Difusor de policarbonato transparente. Cabezal orientable. Luz directa.

Metal body finished in Ecobright aluminium or chrome. Switch included. Transparent polycarbonate diffuser. Adjustable head. Direct light.

Structure métallique avec finitions en aluminium Ecobright et chromées. Interrupteur fourni. Diffuseur en polycarbonate transparent. Tête orientable. Lumière directe.

Metallgehäuse in den Ausführungen Ecobright-Aluminium und Chrom. Inkl. Schalter. Diffusor aus transparentem Polycarbonat. Verstellbares Kopfteil. Direkte Beleuchtung.

Struttura metallica con finitura cromata e alluminio Ecobright. Interruttore compreso. Diffusore in policarbonato trasparente. Testina orientabile. Luce diretta.

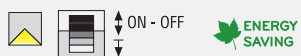

Cromo  
 Chrome  
 Chrom  
 Cromo  
 Aluminio Ecobright  
 Ecobright aluminium  
 Aluminium Ecobright  
 Ecobright aluminium  
 Alluminio Ecobright

21

AH

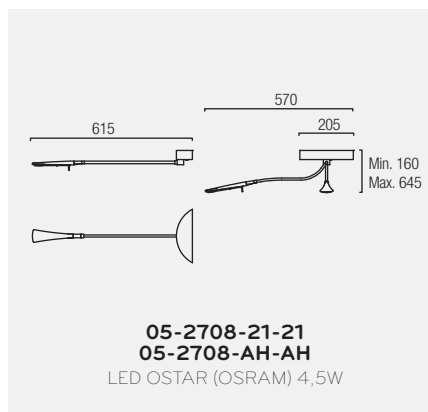



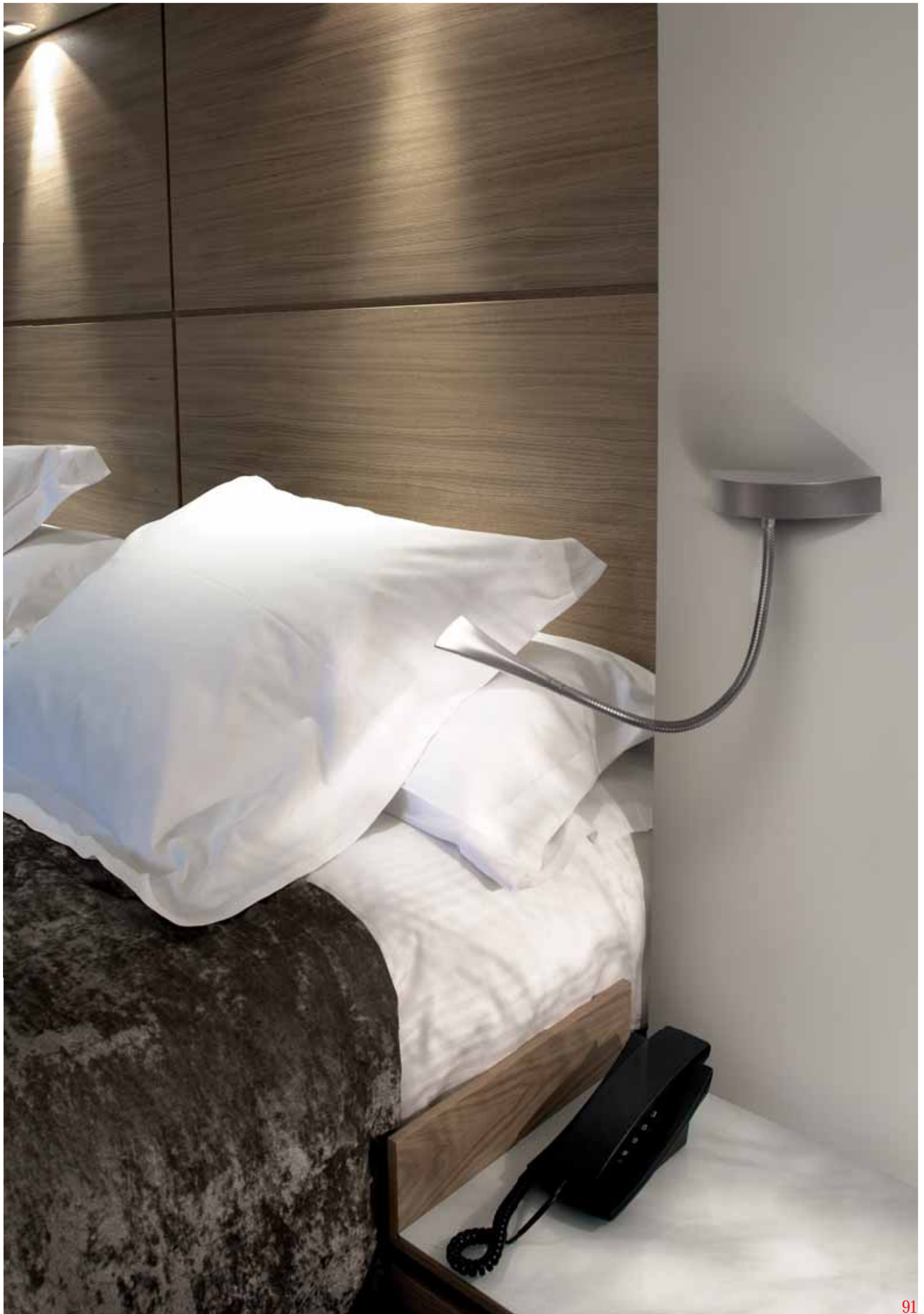

# suite

design \_ Benedito Design

suite\_collection

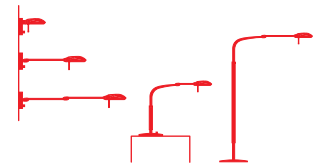

p.92

p.134

p.218

Estructura metálica en acabado níquel satinado. Interruptor-dimmer y luz directa. Difusor de cristal opal satinado. Sin brazo, con brazo articulado y con doble brazo articulado.

Satin nickel metal body. Dimmer switch and direct light. 3 models with satin opal crystal diffuser. No arm, articulated arm or double articulated arm.

Structure métallique avec finitions en nickel satiné. Interrupteur-variateur et lumière directe. Trois modèles dotés d'un diffuseur en verre opale satiné. Sans bras, avec bras articulé simple et avec bras double articulé.

Metallgehäuse in satiniertem Nickel. Dimmer-Schalter und direkte Beleuchtung. 3 Modelle mit Diffusor aus satiniertem Opalglas. Ohne Arm, mit Gelenkarm und mit Doppel-Gelenkarm.

Struttura metallica con finitura nichel satinato. Interruttore-dimmer e luce diretta. 3 modelli con diffusore in cristallo opale satinato. Senza braccio, con braccio articolato e con doppio braccio articolato.



DIMMER

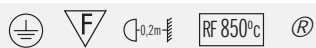

DIMMER



● Níquel Satinado  
Satin nickel  
**81** Nickel satiné  
Nickel matt  
Nichel satinato

○ Cristal opal satinado  
Satin opal glass  
**B8** Verre opal satin  
Satiniertes opales Glas  
Vetro opal satinado

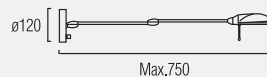

**05-0380-81-B8**

G9 Max. 75W 230V  
HALOGEN OSRAM included

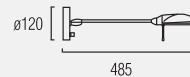

**05-0379-81-B8**

G9 Max. 75W 230V  
HALOGEN OSRAM included

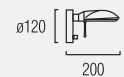

**05-0378-81-B8**

G9 Max. 75W 230V  
HALOGEN OSRAM included



# suite

design \_ Benedito Design

suite\_collection

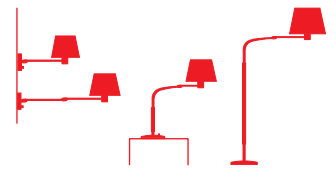

p.94

p.135

p.216

Estructura metálica en acabado níquel satinado con interruptor-dimmer y luz directa. Pantalla de tela gris Ópera.

Satin nickel metal body with dimmer switch and direct light. Grey fabric shade Opera.

Structure métallique avec finitions en nickel satiné. Interrupteur-variateur et lumière directe. Ecran en tissu gris Opéra.

Metallgehäuse in satiniertem Nickel. Dimmer-Schalter und direkter Beleuchtung. Schirm in grauem Opera-Stoff lieferbar.

Struttura metallica con finitura nichel satinato. Interruttore-dimmer e luce diretta. Paralume in tela grigio Opera.

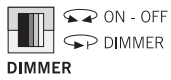

DIMMER



DIMMER



● Níquel Satinado  
Satin nickel  
**81** Nickel satiné  
Nickel matt  
Nichel satinato

● Pantalla Gris Ópera incluida  
Opera Grey shade included  
**AJ** Abat-jour Gris Opéra compris  
Grau Schirm inklusiv  
Paralume grigio inclusa

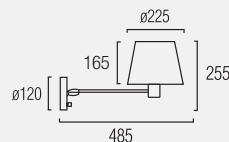

**05-0381-81-AJ**  
E-27 Max. 60W  
INCANDESCENT

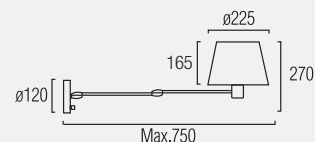

**05-0382-81-AJ**  
E-27 Max. 60W  
INCANDESCENT





# leila

design \_ Benedito Design

leila\_collection

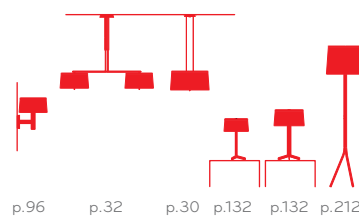

Estructura metálica en acabado cromo y aluminio satinado. Pantallas de tela disponibles en negro y en blanco. Luz directa.

Chrome or satin aluminium body. Fabric shades available in black and white. Direct light.

Structure métallique avec finitions chromées et en aluminium satiné. Écrans en tissu, proposés en noir et en blanc. Lumière directe.

Metallgehäuse, Oberfläche verchromt und aus satiniertem Aluminium. Stoffschirme in Schwarz und Weiß lieferbar. Direkte Beleuchtung.

Struttura metallica con finitura cromata e alluminio satinato. Paralumi in tela disponibili in colore nero e bianco. Luce diretta.



● Aluminium con cromo  
● Aluminium with chrome  
**AG** Aluminium avec chrome  
● Aluminium mit Chrom  
● Alluminio con cromo

● Pantalla negra de tela incluida  
● Black fabric shade included  
**05** Abat-jour noir en tissu compris  
● Schwartz Schirm inklusiv  
● Paralume di tela nero inclusa

● Pantalla blanca de tela incluida  
● White fabric shade included  
**14** Abat-jour blanche en tissu compris  
● Weiss Schirm inklusiv  
● Paralume di tela bianca inclusa

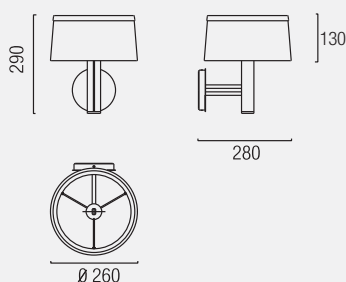

**05-2407-AG-05**  
**05-2407-AG-14**  
G9 Max. 40W  
HALOGEN OSRAM included



# hotels

design \_ Benedito Design

hotels\_collection

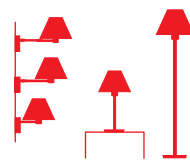

p.98 p.130 p.214

Estructura metálica en acabados níquel y oro satinado pintado. Sin brazo, con brazo articulado y con doble brazo articulado. Portalámparas E-27 y G24d1. Pantalla blanca y beige no incluidas.

Painted satin nickel or gold metallic body. No arm, articulated arm or double articulated arm. E-27 and G24d1 lampholders. White or beige shade not included.

Structure métallique avec finitions en nickel ou or peint satiné. Sans bras, avec bras articulé ou avec bras double articulé. Porte-lampe E-27 ou G24d1. Écran blanc ou beige non fournis.

Metallgehäuse in satinier-tem lackiertem Nickel. Ohne Arm, mit Gelenkarm und mit Doppel-Gelenkarm. Je nach Lampenhalter (E-27 und G24d1) und je nach Schirm (weiß und beige). Schirme nicht im Lieferumfang enthalten.

Struttura metallica con finitura nichel e oro satinato dipinto. Senza braccio, con braccio articolato e con doppio braccio articolato. Portalampada E-27 e G24d1. Paralume bianco e beige non forniti.



Sistema patentado  
Patented system

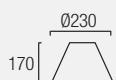

Pan-103-14  
Pan-103-20



● Níquel satinado pintado  
Painted satin nickel  
**U4** Nickel satiné peint  
Lackiertes Nickel matt  
Nichel satinato dipinto

● Oro satinado pintado  
Painted satin gold  
**S8** Or satiné peint  
Lackiertes Gold matt  
Oro satinato dipinto

○ Pantalla blanca  
White shade  
**14** Abat-jour blanc  
Weiss Stoffschirm  
Paralume bianca

○ Pantalla beige  
Beige shade  
**20** Abat-jour beige  
Beige Stoffschirm  
Paralume beige

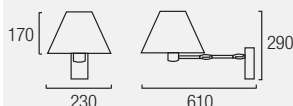

**05-2275-U4-82**  
**05-2275-S8-82**  
E-27 Max. 60W  
INCANDESCENT

**05-2276-U4-82**  
G24d1 13W  
ENERGY SAVING

+ Pan-103-14 / Pan-103-20



**05-2273-U4-82**  
E-27 Max. 60W  
INCANDESCENT

**05-2274-U4-82**  
G24d1 13W  
ENERGY SAVING

+ Pan-103-14 / Pan-103-20

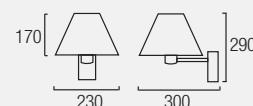

**05-2271-U4-82**  
E-27 Max. 60W  
INCANDESCENT

**05-2272-U4-82**  
G24d1 13W  
ENERGY SAVING

+ Pan-103-14 / Pan-103-20

Para conjunto completo solicite referencias de luminaria y pantalla  
For complete set please order by separate fixture and shade reference



# versatil

design \_ Estudi Ribaudí

Estructura y difusor metálicos en acabado níquel mate. Difusor giratorio y abatible. Interruptor incluido. Luz directa.

Matte nickel body and diffuser. Swivel and hinged diffuser. Switch included. Direct light.

Structure et diffuseur métalliques avec finitions en nickel mat. Diffuseur rotatif et inclinable. Interrupteur fourni. Lumière directe.

Gehäuse und Diffusor aus Metall mit Oberfläche in mattem Nickel. Diffusor dreh- und klappbar. Inkl. Schalter. Direkte Beleuchtung.

Struttura e diffusore metallici, con finitura in nichel opaco. Diffusore girevole e a scomparsa. Interruttore compreso. Luce diretta.

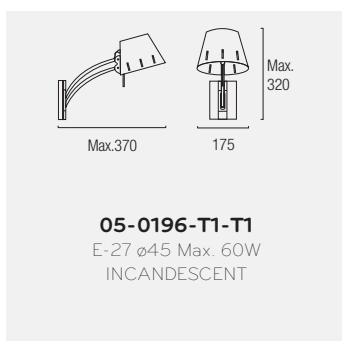
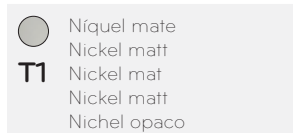
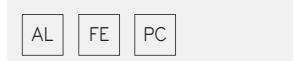
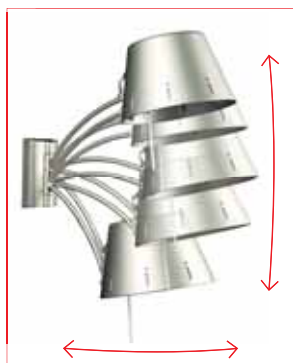







Estructura metálica en acabado níquel satinado. Difusor de cristal óptico matizado. Disponible en 2 tamaños: 20 cms y 30 cms. Luz directa.

Satin nickel metal body. Matte optical glass diffuser. Available in 2 sizes: 20cm and 30cm. Direct light.

Structure métallique avec finitions en nickel satiné. Diffuseur en verre optique teinté. Décliné en deux tailles: 20 cm et 30 cm. Lumière directe.

Metallgehäuse in satinier-tem Nickel. Diffusor aus mattem Optikglas. Mit Durchmesser 30 cm oder 100 cm lieferbar. Direkte Beleuchtung.

Struttura metallica con finitura nichel satinato. Diffusore in cristallo ottico opacizzato. Disponibile in dimensioni da 20 e 30 cm. Luce diretta.

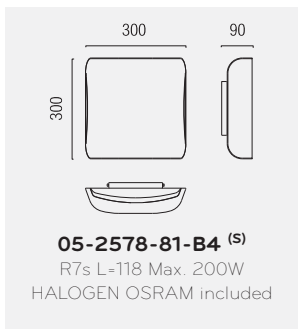
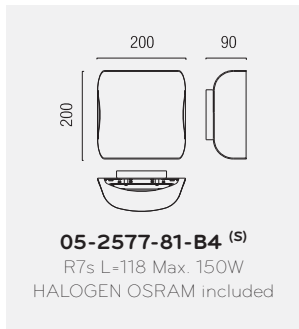

	Níquel Satinado Satin nickel		
<b>81</b>	Nickel satiné Nickel matt Nichel satinato		
	Cristal óptico Optic glass		
<b>B4</b>	Verre optique Optisches Glas Vetro ottico		

Estructura metálica en acabado níquel satinado. Difusor de cristal óptico curvado y matizado. Luz directa.

Satin nickel metal body. Curved and matte optical glass diffuser. Direct light.

Structure métallique avec finitions en nickel satiné. Diffuseur en verre optique courbé et teinté. Lumière directe.

Metallgehäuse in satinier-tem Nickel. Diffusor aus gebogenem, mattiertem Optikglas. Direkte Beleuchtung.

Struttura metallica con finitura nichel satinato. Diffusore in cristallo ottico ricurvo e opacizzato. Luce diretta.



● Níquel Satinado Satin nickel	○ Cristal óptico Optic glass
<b>81</b> Nickel satiné Nickel matt Nichel satinato	<b>E9</b> Verre optique Optishes Glas Vetro ottico

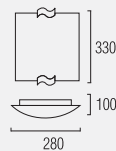

**05-1876-81-E9**

E-27 Max. 100W  
INCANDESCENT  
E-27 Max. 100W  
HALOGEN  
PL E-27 OSRAM 20W  
ENERGY SAVING



# scala

design \_ Josep Patsí / Xavier Muixí

scala\_collection

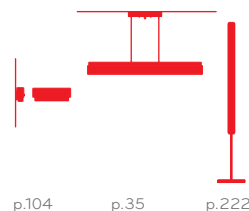

Estructura metálica en acabado cromo. Difusor de cristal fusing con tonos color cava. Luz directa e indirecta.

Chrome metal body. Fusing glass diffuser in pale yellow tones. Direct and indirect light.

Structure métallique avec finitions chromées. Diffuseur en verre fondu avec des tons champagne. Lumière directe et indirecte.

Gehäuse aus verchromtem Metall. Diffusor aus Fusing-Glas mit Sektfarbtönen. Zur direkten und indirekten Beleuchtung.

Struttura metallica con finitura cromata. Diffusore in cristallo fusing, con toni color champagne. Luce diretta e indiretta.

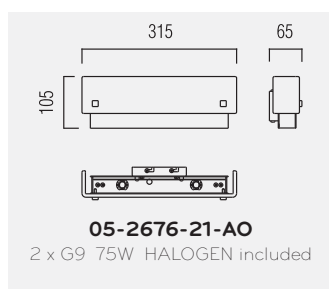
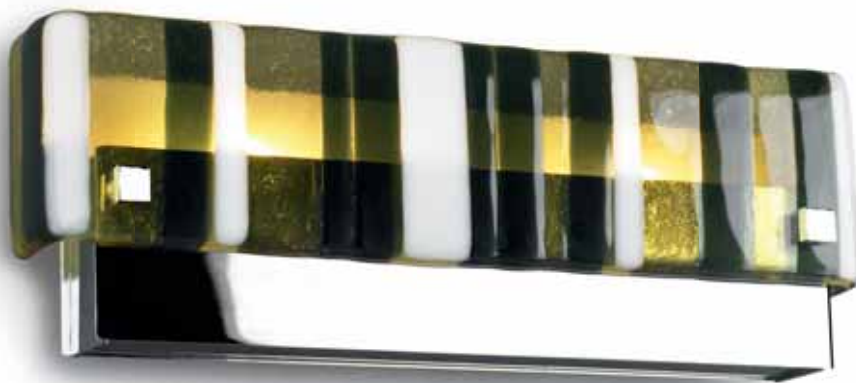

		<b>FUSING</b>	
<p> Cromo</p> <p><b>21</b> Chrome</p> <p>Chrom</p> <p>Cromo</p>	<p> Cristal fusing cava</p> <p><b>AO</b> Fusing cava glass</p> <p>Verre fusing "cava"</p> <p>Sektfarbiges-fusing-Glas</p> <p>Vetro fusing cava</p>		



# otras referencias / other references

YEDAY y STAR son colecciones del catálogo LED (LEDS-C4) / YEDAY and STAR are LED catalogue series (LEDS-C4)



**Serie de apliques led de diseño minimalista realizados en aluminio pulido con junta transparente que crea un efecto de anillo luminoso. Innovadora familia con un espectacular haz de luz concentrado.**

*A series of minimalist led light-fittings executed in polished aluminium with a transparent joint to create an effect of a luminous ring. An innovative family boasting spectacular, concentrated light.*

- 05-3377-S2-00 Led 1-3W ( 50 x 49 x 40) cold / frío
- 05-3378-S2-00 Led 1-3W ( 50 x 49 x 40) warm / cálido
- 05-3381-S2-00 Led 2-6W ( 66 x 49 x 40) cold / frío
- 05-3382-S2-00 Led 2-6W ( 66 x 49 x 40) warm / cálido



## YEDAY



## STAR



**Aplique decorativo de superficie con tecnología led y cuerpo de aluminio. Proyecta 4 flujos luminosos perpendiculares creando un efecto de cuadrícula en la pared, por lo que resulta ideal para ambientes contemporáneos y modernos.**

*A decorative surface led light fitting with an aluminium body. It projects 4 luminous perpendicular beams, creating a grid effect onto the wall, which makes it ideal for contemporary and modern environments*

- 05-3391-N3-00 Led 4W ( Ø96 x 37 x 82) azul/ blue
- 05-3397-N3-00 Led 4W ( Ø96 x 37 x 82) natural





# otras referencias / other references

CLAM es una colección del catálogo ARCHITECTURAL de LEDS-C4 / CLAM is an ARCHITECTURAL catalogue series (LEDS-C4)

Cuerpo metálico acabado en pintura epoxi de color blanco. Vano óptico realizado en chapa doblada con acabado blanco, con reflector incorporado de aluminio de alta pureza (99%). Disponible en 2 diámetros: 200 y 400mm, con fuentes de luz FLC y Halógenas (para versión LED RGB consultar).

El cuerpo va fijado a un marco de pre-instalación suministrado que permite la rotación de la luminaria para un enfoque óptimo del flujo luminoso a la vez que integra la pieza perfectamente en el entorno (concepto trimless). Los equipos quedan suspendidos del chasis del vano óptico facilitando la instalación y mantenimiento de los mismos.

CLAM ha nacido para integrarse en la arquitectura. Su concepto Trimless aunado a su mínima profundidad de instalación le permite ser instalado en muros tipo Pladur de 15 mm.

*Metallic body finished in white epoxy paint. Optic device made of steel with a high purity anodised aluminium reflector (99%).*

*Available in 2 diameters: 200 and 400mm and 3 different lamp sources: CFL and halogen (for RGB LED version please advise).*

*The housing is fixed onto the supplied mounting kit allowing the rotation of the fitting and its output while integrating it on the wall. The gear hangs from the optic device housing to facilitate installation and maintenance.*

*CLAM means architecture's integration. Its Trimless concept together with its minimum depth allows it to be mounted in double plasterboard walls (15mm. depth).*

EP-1601-14-14 QT-16 G9 max. 40W (250 x Ø197 x 61 cm)

EP-1602-14-14 TC-DEL G24q-2 18W (365 x Ø197 x 61 cm)

EP-1608-14-14 TC-F 2G10 24W (582 x Ø397 x 65 cm)

EP-1605-14-14 QT-16 G9 max. 60W (445 x Ø397 x 65 cm)

EP-1610-14-14 CDM-Tm PGJ5 max. 60W (445 x Ø397 x 65 cm)

# CLAM



# otras referencias / other references

SMART y THIN son colecciones del catálogo LED (LEDS-C4) / SMART and THIN are LED catalogue series (LEDS-C4)



**Aplique inteligente de señalización, con tecnología led, de diseño contemporáneo con cuerpo de aluminio inyectado.**

**Incorpora un sensor infrarrojo de movimiento y un sensor detector de luz. Excelente para garantizar la seguridad en la oscuridad, proyectando un haz de luz cálido hacia el suelo al detectar el movimiento.**

**Versión empotrada o de superficie fácilmente adaptable.**

*Intelligent led light-fitting indicator with a modern design, featuring an injected aluminium body. It includes an infrared movement sensor and a light detector. Excellent to guarantee safety in the dark, projecting a warm beam of light towards the floor when it detects movement. Easily adaptable fitted or surface version.*

05-3303-N3-00 Led 11W ( 110 x 110 x 34) warm / cálido

71-3303-N3-00 ( 110 x 110 x 36,5) Caja para montaje en superficie / Surface kit



**Aplique inteligente de señalización que incorpora un sensor infrarrojo de movimiento y un sensor detector de luz.**

*Intelligent led light-fitting indicator that includes an infrared movement sensor and a light detector.*

# SMART

(ENERGY SAVING)

# THIN

(ENERGY SAVING)

**Kit de tres luminarias led minimalistas de señalización con un único controlador de equipo. Extremadamente delgado, ideal para suelos, paredes y techos de madera... permite una rápida y cómoda instalación en cualquier localización. El cuerpo está fabricado en aluminio con frontal de policarbonato resistente al peso y elevada estanqueidad.**

*A kit of three minimalist signposting led lights with a unique controller. It is extremely slim and ideal for wooden floors, walls and ceilings ... it enables rapid and convenient installation in any location. Features an aluminium body with a weight resistant polycarbonate frontal that is highly water resistant.*

55-3357-54-M3 Led 3 x 0,5W ( Ø55 x 8) warm / cálido







\_sobremesas  
\_table lamps  
\_lampes de tables  
\_tischleuchten  
\_lampade da tavolo

escher\_110  
arc\_114  
troppo\_116  
adagio\_118  
bonne nuit\_120  
class\_122  
adn\_123  
umbrella\_124  
everyday\_126  
gloria\_128  
hotels\_130  
soul\_131  
leila\_132  
suite\_134  
open\_136  
office\_138  
totem mini\_140

# escher

design \_ Josep Patsí

escher\_collection

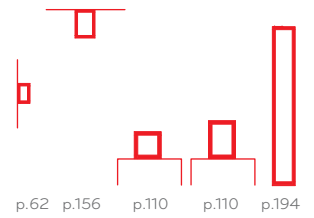

Estructura metálica en 3 acabados disponibles: aluminio Ecobright, lacado blanco y lacado negro. Los 3 acabados están disponibles en tamaño grande, con interruptor push-dimmer incorporado, y en tamaño pequeño, con interruptor-dimmer incluido. Cable de tela. Luz indirecta.

Metal body available in 3 finishes: Ecobright, black lacquer or white lacquer. The 3 finishes are available in large, with incorporated push-dimmer switch; and small, with dimmer switch included. Cord cable. Indirect light.

Structure métallique proposée avec trois finitions : aluminium Ecobright, verni blanc et verni noir. Celles-ci existent en grande taille avec interrupteur poussoir-variateur incorporé et en petite taille avec interrupteur-variateur fourni. Câble en tissu. Lumière indirecte.

Metallgehäuse in 3 Ausführungen lieferbar: Ecobright-Aluminium, weiß lackiert und schwarz lackiert. Die 3 Oberflächenausführungen sind in großer Größe, mit integriertem Push-Dimmerschalter und in kleiner Größe mit Dimmerschalter lieferbar. Textilkabel. Indirekte Beleuchtung.

Struttura metallica disponibile con 3 finiture: alluminio Ecobright, laccato bianco e laccato nero. Le 3 finiture sono disponibili in dimensione grande, con interruttore push-dimmer incorporato e in dimensione piccola, con interruttore dimmer compreso. Cavo in tela. Luce indiretta.

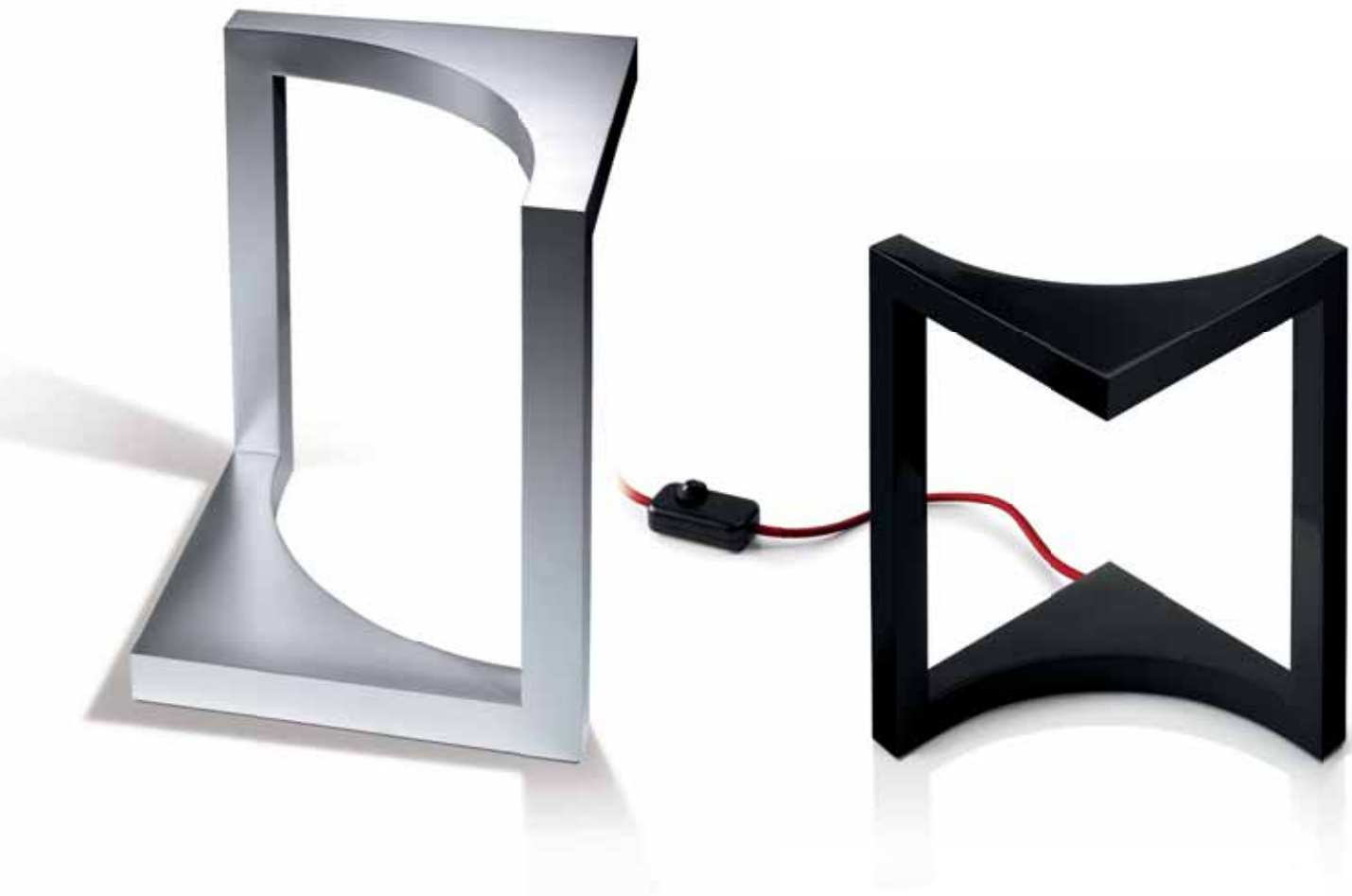

<b>AH</b> Aluminium Ecobright Ecobright aluminium Aluminium Ecobright Ecobright aluminium Alluminio Ecobright	<b>05</b> Lacado negro Black lacquered Laqué en noir Schwarz lackiert Laccato nero	<b>78</b> Lacado blanco White lacquered Laqué en blanc Weiss lackiert Laccato bianco	

**10-2782-AH-AH**  
**10-2782-05-05**  
**10-2782-78-78**  
G9 75W  
HALOGEN OSRAM included-  
Push dimmer

**10-2809-AH-AH**  
**10-2809-05-05**  
**10-2809-78-78**  
G9 60W  
HALOGEN OSRAM included  
Dimmer





escher







# arc

design \_ Estudi Ribaudí

arc\_collection

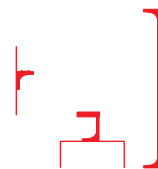

p.66 p.114 p.206

Estructura de aluminio y difusor de metacrilato matizado. Disponible en 3 acabados: aluminio Ecobright, lacado blanco y lacado negro. Interruptor incluido. Luz directa e indirecta.

Aluminium body and matte methacrylate diffuser. Available in 3 finishes: Ecobright, black lacquer or white lacquer. Switch included. Direct and indirect light.

Structure en aluminium et diffuseur en méthacrylate teinté. Proposée avec trois finitions : aluminium Ecobright, verni blanc et verni noir. Interrupteur fourni. Lumière directe et indirecte.

Gehäuse aus Aluminium und Diffusor aus mattiertem Plexiglas. In 3 Ausführungen lieferbar: Ecobright-Aluminium, weiß lackiert und schwarz lackiert. Inkl. Schalter. Zur direkten und indirekten Beleuchtung.

Struttura in alluminio e diffusore in metacrilato opacizzato. Disponibile in 3 finiture: alluminio Ecobright, laccato bianco e laccato nero. Interruttore compreso. Luce diretta e indiretta.

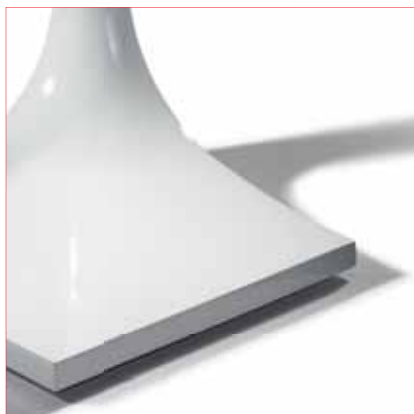

● Aluminium Ecobright  
Ecobright aluminium  
**AH** Aluminium Ecobright  
Ecobright aluminium  
Alluminio Ecobright

● Lacado negro  
Black lacquered  
**05** Laqué en noir  
Schwarz lackiert  
Laccato nero

○ Lacado blanco  
White lacquered  
**78** Laqué en blanc  
Weiss lackiert  
Laccato bianco

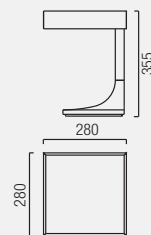

**10-2580-AH-AH**  
**10-2580-05-05**  
**10-2580-78-78**

T5 circular 22W  
FLUORESCENT included





# tropo

design\_ Benedito Design

tropo\_collection

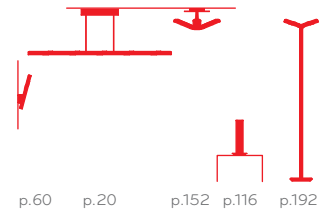

Estructura de aluminio acabado en cromo. Cristal de borosilicato matizado. Elegante combinación de formas simples: línea y círculo. Dimmer switch incluido. Emite luz directa y también indirecta gracias a la apertura de la parte posterior de la estructura.

Chrome aluminium body. Matte borosilicate glass. Elegant combination of simple shapes - lines and circles. Dimmer switch included. Provides direct and indirect light thanks to an opening on the back of the luminaire.

Structure en aluminium avec finitions chromées. Verre en borosilicate teinté. Combinaison élégante de formes simples telles que des lignes et des cercles. Interrupteur-variateur fourni. Émet une lumière directe mais aussi indirecte grâce à l'ouverture de la partie postérieure de la structure.

Gehäuse aus verchromtem Aluminium. Mattiertes Borosilikat-Glas. Elegante Kombination einfacher Formen: Linie und Kreis. Inkl. Dimmerschalter. Direkte Beleuchtung sowie indirekte Beleuchtung durch die Öffnung an der Rückseite der Leuchte.

Struttura in alluminio con finitura cromata. Cristallo di borosilicato opacizzato. Elegante accostamento di forme semplici: linee e cerchi. Interruttore dimmer compreso. Emette luce diretta e indiretta, anche grazie all'apertura nella parte posteriore della struttura.

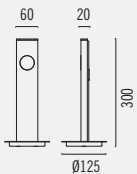

**10-2804-21-F1**

G9 60W

HALOGEN OSRAM included



● Cromo  
Chrome  
21 Chrome  
Chrom  
Cromo

○ Cristal anti-deslumbrante  
Anti-glare glass  
F1 Verre antiéblouissante  
Blendfreies Glas  
Vetro antiriflesso



# adagio

design \_ Josep Patsí

adagio\_collection

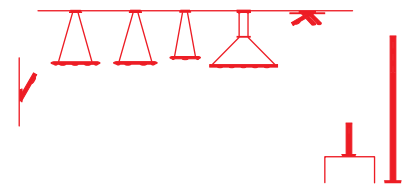

p.68 p.38 p.39 p.38 p.36 p.166 p.118 p.209

Estructura de aluminio y difusor de cristal anti-deslumbrante. Disponible en acabados cromo y aluminio pulido satinado. Interruptor incorporado. Emite luz directa y también indirecta gracias a la apertura de la parte posterior de la estructura.

Aluminium body and anti-glare glass diffuser. Available in chrome or polished and satin aluminium. Incorporated switch. Provides direct and indirect light thanks to an opening on the back of the luminaire.

Structure en aluminium et diffuseur en verre antireflets. Proposée avec des finitions chromées et en aluminium poli satiné. Interrupteur incorporé. Émet une lumière directe mais aussi indirecte grâce à l'ouverture de la partie postérieure de la structure.

Gehäuse aus Aluminium und Diffusor aus entspiegeltem Glas. Verchromt und in poliertem satinier-tem Aluminium lieferbar. Inkl. Schalter. Direkte Beleuchtung sowie indirekte Beleuchtung durch die Öffnung an der Rückseite der Leuchte.

Struttura in alluminio e diffusore in cristallo anti-abbagliamento. Disponibile con finitura in cromo e alluminio lucido satinato. Interruttore incorporato. Emette luce diretta e indiretta, anche grazie all'apertura nella parte posteriore della struttura.

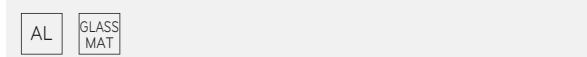

- Cromo
- Chrome
- 21** Chrome
- Chrom
- Cromo
- Aluminio pulido y satinado
- Polished and burnished aluminium
- S3** Aluminium poli et satiné
- Aluminium poliert und mattglänzend
- Alluminio lucidato e satinato

- Cristal anti-deslumbrante
- Anti-glare glass
- F1** Verre antiéblouissante
- Blendfreies Glas
- Vetro antiriflesso

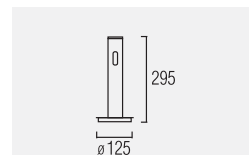

**10-0221-21-F1**  
**10-0221-S3-F1**  
 G9 Max. 60W 230V  
 HALOGEN OSRAM included

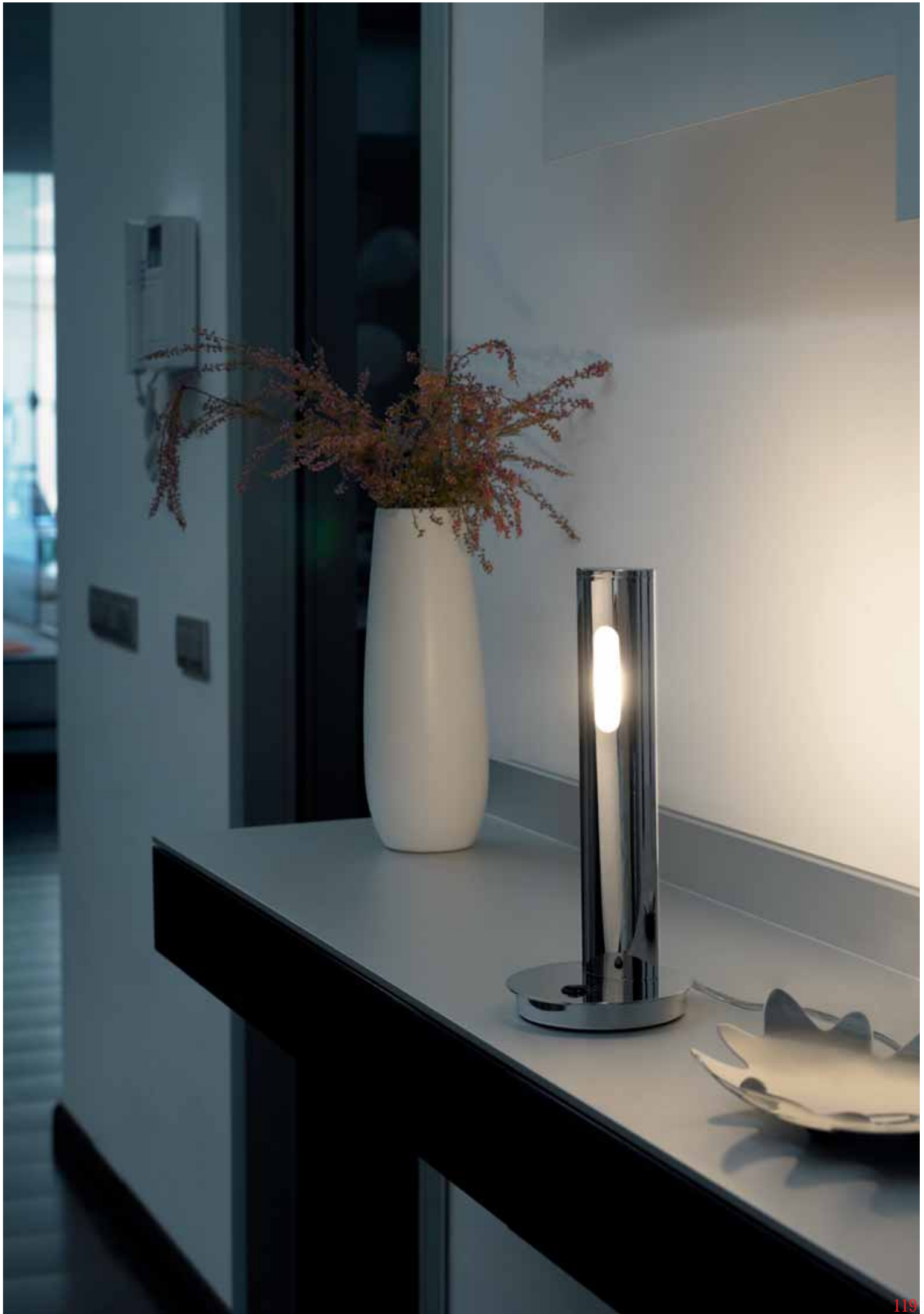

# bonne nuit

design \_ Benedito Design

Estructura metálica en acabado níquel satinado. Difusor de cristal opal triplex. Interruptor incluido. Luz directa.

Satin nickel metal body. Triplex optical glass diffuser. Switch included. Direct light.

Structure métallique avec finitions en nickel satiné. Diffuseur en verre opale triplex. Interrupteur fourni. Lumière directe.

Metallgehäuse in satiniertem Nickel. Diffusor aus Triplex-Opalglas. Inkl. Schalter. Direkte Beleuchtung.

Struttura metallica con finitura nichel satinato. Diffusore in cristallo opale triplex. Interruttore compreso. Luce diretta.



● Níquel Satinado  
Satin nickel  
**81** Nickel satiné  
Nickel matt  
Nichel satinato

○ Cristal opal triplex  
Triplex Opal glass  
**F9** Verre opal triplex  
Optishes Glas  
Vetro ottico

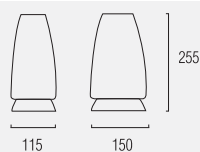

**10-2056-81-F9**  
E-27 ø45 Max. 60W  
INCANDESCENT  
PL ELECT E-27 15W  
ENERGY SAVING





# class

design \_ Josep Patsí

class\_collection

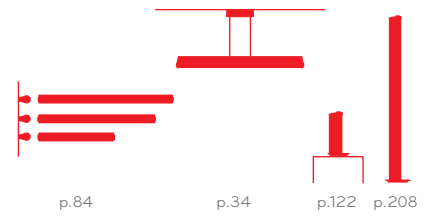

Estructura de aluminio Ecobright. Doble difusor: interior de policarbonato opal y exterior de borosilicato transparente. Interruptor incorporado. Luz directa.

Ecobright aluminium body. Double diffuser - inner: opal polycarbonate, exterior: transparent borosilicate. Incorporated switch. Direct light.

Structure en aluminium Ecobright. Double diffuseur: intérieur en polycarbonate opale et extérieur en borosilicate transparent. Interrupteur incorporé. Lumière directe.

Gehäuse aus Ecobright-Aluminium. Doppelter Diffusor: Innen aus Opal-Polykarbonat und außen aus transparentem Borosilikat. Inkl. Schalter. Direkte Beleuchtung.

Struttura in alluminio Ecobright. Doppio diffusore: interno in policarbonato opale ed esterno in borosilicato trasparente. Interruttore incorporato. Luce diretta.



Doble difusor  
Double diffuser  
Diffuseur double  
Doppelglas  
Difusore doppio



	ENERGY SAVING		
AL	PC	GLASS BOSI	
	Aluminio Ecobright Ecobright aluminium <b>AH</b> Aluminium Ecobright Ecobright aluminium Alluminio Ecobright		

**10-2694-AH-37 (S)**  
T5 8W FLUORESCENT included



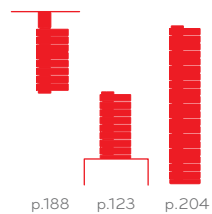

Estructura metálica y embellecedores de ABS, ambos en acabado cromo. Difusor compuesto por 8 pantallas giratorias de color blanco escarcha. Interruptor incluido. Luz directa.

Metal body and ABS trims, both finished in chrome. Diffuser consisting of 8 swivel frosted white shades. Switch included. Direct light.

Structure métallique et caches en ABS avec finitions chromées. Diffuseur composé de huit écrans rotatifs en blanc glacé. Interrupteur fourni. Lumière directe.

Metallgehäuse und Zierblende aus ABS, verchromt. Diffusor aus 8 drehbaren in Ice-Weiß. Inkl. Schalter. Direkte Beleuchtung.

Struttura metallica ed elementi di finitura in ABS, entrambi con finitura cromata. Diffusore composto da 8 paralumi girevoli in colore bianco ghiaccio. Interruttore compreso. Luce diretta.



	<p><b>21</b> Cromo Chrome Chrom Cromo</p>	<p><b>AL</b> Pantallas Blanco Escarcha incluidas Iced white shades included Abat-jour gelée blanche compris Weiss Schirm inklusiv Paralume bianco brina inclusa</p>

**10-2705-21-AL**  
T5 24W  
FLUORESCENT included



# umbrella

design \_ WIS design

umbrella\_collection

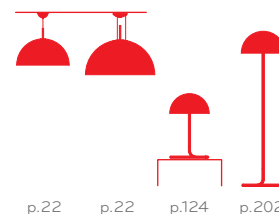

Estructura metálica con pantalla semiesférica de aluminio. Hay 2 versiones disponibles: acabado lacado blanco con pantalla interior plisada plata y acabado lacado negro con pantalla interior plisada dorada. Interruptor incluido. Cable de tela. Luz directa.

Metal body with hemisphere aluminium shade. Available in 2 versions: white lacquer finish with inner silver pleated shade and black lacquer finish with inner gold pleated shade. Switch included. Cord cable. Direct light.

Structure métallique avec écran semisphérique en aluminium. Existe en deux déclinaisons: une avec finitions en vernis blanc avec écran intérieur plissé couleur argent et une autre avec finitions en vernis noir avec écran intérieur plissé couleur doré. Interrupteur fourni. Câble en tissu. Lumière directe.

Metallgehäuse mit halbrundem Schirm aus Aluminium. In 2 Ausführungen lieferbar: weiß lackierte Oberfläche mit silberfarben-plissiertem Innenschirm und schwarz lackierte Oberfläche mit goldfarben-plissiertem Innenschirm. Inkl. Schalter. Textilkabel. Direkte Beleuchtung.

Struttura metallica con paralume semisferico in alluminio. 2 versioni disponibili: finitura laccata bianca con paralume interno plissettato colore argento e finitura laccata nera, con paralume interno plissettato dorato. Interruttore compreso. Cavo in tela. Luce diretta.

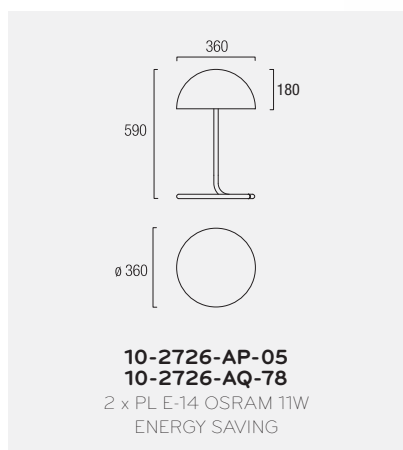

**AP** Pantalla interior plisada dorada  
Golden pleated interior shade  
Intérieur d'abat-jour plissé doré  
Schirm, Innenseite Gold plissée  
Paralume interna plisata oro

**AQ** Pantalla interior plisada plata  
Silver pleated interior shade  
Intérieur d'abat-jour plissé argenté  
Schirm, Innenseite Silver plissée  
Paralume interna plisada argento

**05** Lacado negro  
Black lacquered  
Laqué en noir  
Schwarz lackiert  
Laccato nero

**78** Lacado blanco  
White lacquered  
Laqué en blanc  
Weiss lackiert  
Laccato bianco





# everyday

design \_ JBA design

everyday\_collection

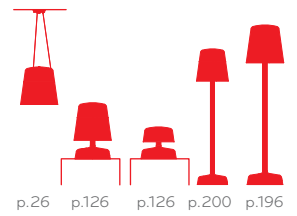

Estructura metálica blanca. Disponible con y sin difusor de cristal opal triplex. Interruptor de diseño. Cable de tela. Luz directa e indirecta.

White metal body. Available with or without triplex optical glass diffuser. Design switch. Cord cable. Direct and indirect light.

Structure métallique blanche. Proposée avec ou sans diffuseur en verre opale triplex. Interrupteur design. Câble en tissu. Lumière directe et indirecte.

Metallgehäuse, weiß. Lieferbar mit und ohne Diffusor aus Triplex-Opalglas. Design-Schalter. Textilka- bel. Zur direkten und indi- rekten Beleuchtung.

Struttura metallica bianca. Disponibile con e senza diffusore in cristallo opale triplex. Interruttore di design. Cavo in tela. Luce di- retta e indiretta.



			<b>ENERGY SAVING</b>
<b>FE</b>			
	Blanco		Cristal opal triplex
	White		Triplex Opal glass
<b>14</b>	Blanc	<b>F9</b>	Verre opal triplex
	Weiss		Optisches Glas
	Bianco		Vetro ottico

**10-2729-14-14**  
2 x E-14 Max. 40W  
INCANDESCENT  
2 x PL E-14 OSRAM 11W  
ENERGY SAVING

**10-2728-14-F9**  
E-27 Max. 100W  
INCANDESCENT  
PL E-27 OSRAM 23W  
ENERGY SAVING



Estructura metálica en acabado níquel satinado con detalles en cromo. El difusor combina cristal anti-deslumbrante y pantalla plisada (no incluida). Interruptor incorporado en la parte superior. Posibilidad de esconder el cableado debajo de la base. Luz directa e indirecta.

Satin nickel body with chrome details. The diffuser combines anti-glare glass with pleated shade (not included). Switch incorporated in upper part. Cables can be hidden under the base. Direct and indirect light.

Structure métallisée avec finitions en nickel satiné, avec des détails chromés. Le diffuseur intègre du verre antireflets et un écran plissé (non fourni). Interrupteur incorporé sur la partie supérieure. Câble rangeable sous le socle. Lumière directe et indirecte.

Metallgehäuse in satinier-tem Nickel mit verchromten Details. Der Diffusor kombiniert entspiegeltes Glas und einen plissierten Schirm (nicht im Preis enthalten). Inkl. Schalter an Oberseite. Kabel lässt sich unter dem Fuß verstecken. Zur direkten und indirekten Beleuchtung.

Struttura metallica con finitura nichel satinata e finiture cromate. Il diffusore abbina cristallo anti-abbagliamento e paralume plissettato (non fornito). Interruttore integrato nella parte superiore. Possibilità di inserire il cavo sotto la base. Luce diretta e indiretta.



● Níquel satinado con cromo  
Satin nickel with chrome  
**N6** Nickel satiné avec chrome  
Nickel matt mitt Chrom  
Nichel satinato con cromo

Cristal anti-deslumbrante  
Anti-glare glass  
Verre antiéblouissante  
Blendfreies Glas  
Vetro antiriflesso

Pantalla Plisada  
Pleated cloth shade  
Abat-jour en tissu plissé  
Schirm aus Plisseestoff  
Paralume plissettato

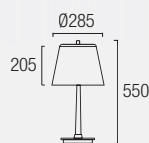

**10-2278-N6-82**  
**+ Pan-100-14**  
2 x E-14 Max. 60W  
INCANDESCENT

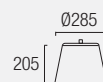

**Pan-100-14**

Para conjunto completo solicite referencias de luminaria y pantalla  
For complete set please order by separate fixture and shade references





# hotels

design \_ Benedito Design

hotels\_collection

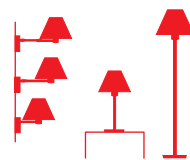

p.98 p.130 p.214

Estructura metálica. Hay 4 posibles combinaciones: en función del acabado, níquel satinado pintado u oro pintado; y en función de la pantalla, blanca o beige. Pantallas no incluidas. Interruptor incluido. Luz directa e indirecta.

Metal body. Available in 4 combinations: according to finish (painted satin nickel or painted gold) or shade (white or beige). Shades not included. Switch included. Direct and indirect light.

Structure métallique. Quatre combinaisons possibles en fonction des finitions (couleur nickel satiné ou peint en doré) et de l'écran (blanc ou beige). Écrans non fournis. Interrupteur fourni. Lumière directe et indirecte.

Metallgehäuse. 4 mögliche Kombinationen: Oberfläche in lackiertem satiniertem Nickel oder goldfarben lackiert. Lampenschirm weiß oder beige. Schirme nicht im Lieferumfang enthalten. Inkl. Schalter. Zur direkten und indirekten Beleuchtung.

Struttura metallica. Esistono 4 possibili combinazioni: in funzione della finitura, nickel satinato dipinto o oro dipinto e, in funzione del paralume, bianco o beige. Paralumi non forniti. Interruttore compreso. Luce diretta e indiretta.

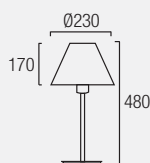

**10-2271-U4-82**  
**10-2271-S8-82**  
 E-27 Max. 60W  
 INCANDESCENT  
 +  
**Pan-103-14**  
 / **Pan-103-20**

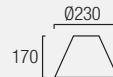

**Pan-103-14**  
**Pan-103-20**



● Níquel satinado pintado  
 Painted satin nickel  
**U4** Nickel satiné peint  
 Lackiertes Nickel matt  
 Nickel satinato dipinto

● Oro satinado pintado  
 Painted satin gold  
**S8** Or satiné peint  
 Lackiertes Gold matt  
 Oro satinato dipinto

○ Pantalla blanca  
 White shade  
**14** Abat-jour blanc  
 Weiss Stoffschirm  
 Paralume bianca

○ Pantalla beige  
 Beige shade  
**20** Abat-jour beige  
 Beige Stoffschirm  
 Paralume beige

Para conjunto completo solicite referencias de luminaria y pantalla  
 For complete set please order by separate fixture and shade reference





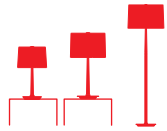

p.131 p.131 p.215

Estructura metálica en acabado cromo. Difusor superior de cristal fumé. Pantalla, de color negro soirée o blanco escarcha. Pantalla de tela incluida. Interruptor-dimmer incluido. 2 tamaños de lámpara.

Chrome metal body. Upper smoked glass diffuser. Soirée black or frosted white shade. Fabric shade included. Dimmer switch included. 2 sizes

Structure métallique avec finitions chromées. Diffuseur supérieur en verre fumé. Écran (couleur noir soirée ou blanc glacé). Écran en tissu fourni. Interrupteur-variateur fourni. 2 tailles.

Gehäuse aus verchromtem Metall. Oberer Diffusor aus Fumé-Glas. Schirm: Soirée-Schwarz oder Ice-Weiß. Mit Stoffschirm. Inkl. Dimmerschalter. Beleuchtung. 2 lieferbar.

Struttura metallica con finitura cromata. Diffusore superiore in cristallo fumé. Paralume, di colore nero soirée o bianco ghiaccio. Compreso paralume in tela. Interruttore dimmer compreso. 2 dimensioni

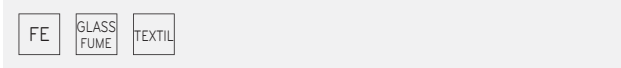
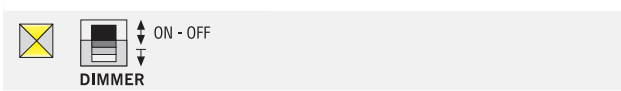
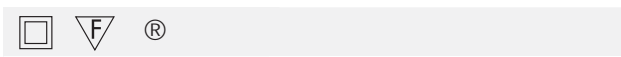
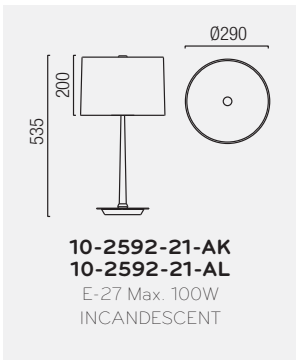
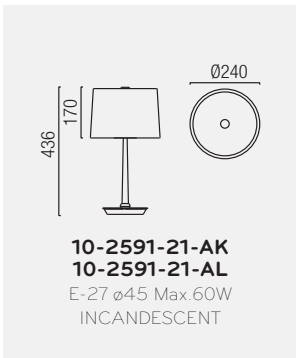
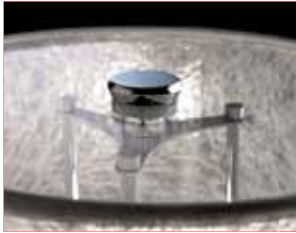

- Cromo  
 Chrome  
 Chrom  
 Cromo
- Pantalla negra de tela incluida  
 Black fabric shade included  
**AK** Abat-jour noir en tissu compris  
 Schwarz Schirm inklusiv  
 Paralume di tela nero inclusa
- Cristal fumé  
 Smoked glass  
 Verre fumé  
 Fumé Glas  
 Vetro fumé
- Pantalla blanca de tela incluida  
 White fabric shade included  
**AL** Abat-jour blanche en tissu compris  
 Weiss Schirm inklusiv  
 Paralume di tela bianca inclusa



# leila

design \_ Benedito Design

leila\_collection

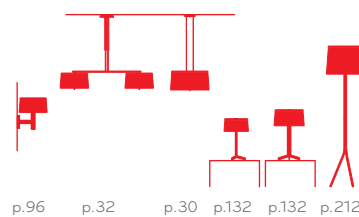

Estructura de la base de metal en acabado cromo y pie de aluminio satinado. Cristal superior óptico matizado. Disponible en 2 tamaños, cada uno con pantalla de tela de color negro o blanco. Interruptor incluido. Luz directa e indirecta.

Chrome base and satin aluminium foot. Upper matte optical glass. Available in 2 sizes, each with fabric shade in black or white. Switch included. Direct and indirect light.

Structure du socle en métal avec finitions chromées et pied en aluminium satiné. Verre optique supérieur teinté. Proposée en deux tailles, chacune avec écran en tissu noir ou blanc. Interrupteur fourni. Lumière directe et indirecte.

Basis aus verchromtem Metall und Fuß aus satiniertem Aluminium. Oberglas aus mattiertem Optikglas. In 2 Größen lieferbar, Schirm aus Stoff in Schwarz oder Weiß. Inkl. Schalter. Zur direkten und indirekten Beleuchtung.

Struttura della base di metallo con finitura cromata e base in alluminio satinato. Cristallo superiore ottico opacizzato. Disponibile in 2 dimensioni, ciascuna con paralume di tela di colore nero o bianco. Interruttore compreso. Luce diretta e indiretta.



Cristal óptico  
Optic glass



**AG** Aluminio con cromo  
Aluminium with chrome  
Aluminium avec chrome  
Aluminium mit Chrom  
Alluminio con cromo

**05** Pantalla negra de tela incluida  
Black fabric shade included  
Abat-jour noir en tissu compris  
Schwarz Schirm inklusiv  
Paralume di tela nero inclusa

**14** Pantalla blanca de tela incluida  
White fabric shade included  
Abat-jour blanche en tissu compris  
Weiss Schirm inklusiv  
Paralume di tela bianca inclusa

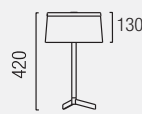

Ø 260

**10-2407-AG-05**  
**10-2407-AG-14**  
G9 Max. 75W  
HALOGEN OSRAM included



Ø 330

**10-2571-AG-05**  
**10-2571-AG-14**  
2 x E-14 Max. 60W  
INCANDESCENT

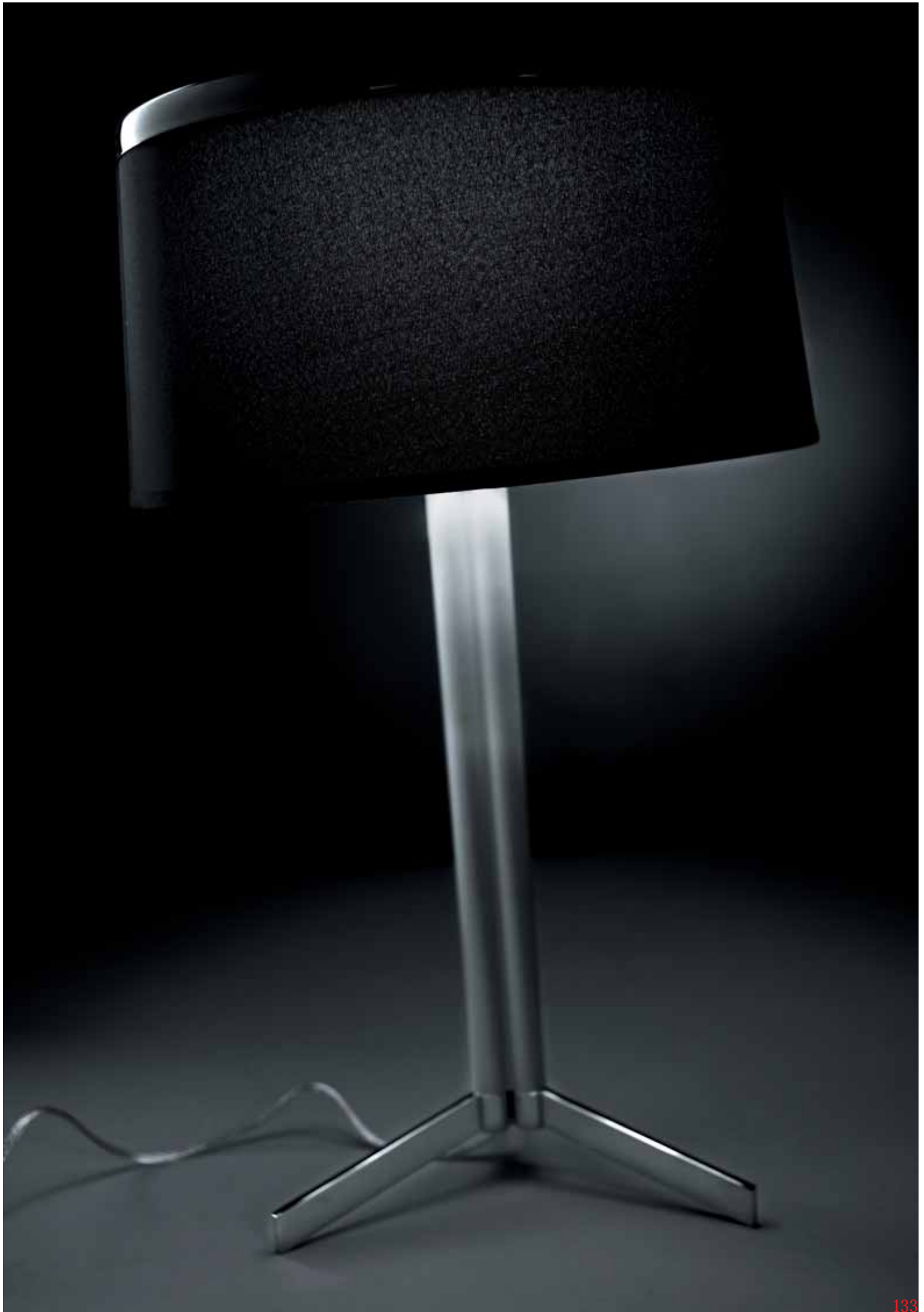

# suite

design \_ Benedito Design

suite\_collection

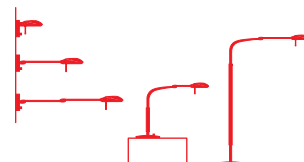

p.92

p.134

p.218

Estructura metálica en acabado níquel satinado. Difusor de cristal opal satinado. Interruptor-dimmer incorporado. Luz directa e indirecta.

Satin nickel metal body. Satin opal glass diffuser. Dimmer switch incorporated. Direct and indirect light.

Structure métallique avec finitions en nickel satiné. Diffuseur en verre opale satiné. Interrupteur-variateur incorporé. Lumière directe et indirecte.

Metallgehäuse in satiniertem Nickel. Diffusor aus satiniertem Opalglas. Einschl. eingebautem Dimmerschalter. Zur direkten und indirekten.

Struttura metallica con finitura nichel satinato. Diffusore in cristallo opale satinato. Interruttore dimmer integrato. Luce diretta e indiretta.



DIMMER

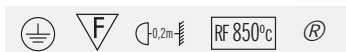

DIMMER

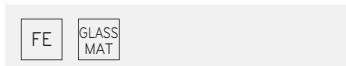

- Níquel Satinado  
Satin nickel  
**81** Nickel satiné  
Nickel matt  
Nichel satinato
- Cristal opal satinado  
Satin opal glass  
**B8** Verre opal satin  
Satiniertes opales Glas  
Vetro opal satinado

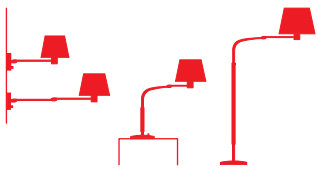

p.94

p.135

p.216

Estructura metálica en acabado níquel satinado. Pantalla de tela gris Ópera (incluida). Interruptor-dimmer incorporado. Luz directa e indirecta.

Satin nickel metal body. Grey fabric shade, Opera (included). Dimmer switch incorporated. Direct and indirect light.

Structure métallique avec finitions en nickel satiné. Écran en tissu gris Opéra. Interrupteur-varianteur incorporé. Lumière directe et indirecte.

Metallgehäuse in satiniertem Nickel. Lieferbar mit Schirm aus grauem Opéra-Stoff (im Preis enthalten). Einschl. eingebautem Dimmerschalter. Zur direkten und indirekten Beleuchtung.

Struttura metallica con finitura nichel satinato. Paralume di tela grigia Opera (fornito). Interruttore dimmer integrato. Luce diretta e indiretta.

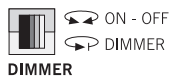

**DIMMER**



**DIMMER**



● Níquel Satinado  
Satin nickel

**81** Nickel satiné  
Nickel matt  
Nichel satinato

● Pantalla Gris Ópera incluida  
Opera Grey shade included  
**AJ** Abat-jour Gris Opéra compris  
Grau Schirm inklusiv  
Paralume grigio inclusa



# open

design \_ Josep Patsi

open\_collection

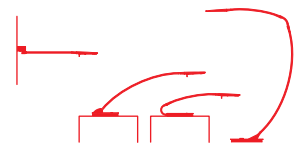

p.90 p.136 p.136 p.220

Estructura de aluminio en acabados Ecobright y cromo, ambos disponibles en formato basculante y en formato flexo orientable. Interruptor incorporado. Difusor de policarbonato transparente. Cabezal orientable. Luz directa.

Aluminium body in Ecobright or chrome finishes; both available in tilt or directionable flex format. Incorporated switch. Transparent polycarbonate diffuser. Adjustable head. Direct light.

Structure en aluminium avec finitions en Ecobright et chromées, toutes deux proposées dans un format à bascule ou flexible et orientable. Interrupteur incorporé. Diffuseur en polycarbonate transparent. Tête orientable. Lumière directe.

Gehäuse aus Aluminium in Ecobright und Chrom, beide Oberflächenauflösungen kippbar und flexo-regulierbar lieferbar. Inkl. Schalter. Diffusor aus transparentem Polykarbonat. Verstellbares Kopfteil. Direkte Beleuchtung.

Struttura di alluminio con finitura Ecobright e cromo, entrambe disponibili in formato basculante e in formato flexo orientabile. Interruttore incorporato. Diffusore in policarbonato trasparente. Testina orientabile. Luce diretta.



		ON - OFF	
AL	FE	PC	
Cromo	Aluminio Ecobright		
Chrome	Ecobright aluminium		
<b>21</b>	<b>AH</b>		
Chrome	Aluminium Ecobright		
Chrom	Ecobright aluminium		
Cromo	Alluminio Ecobright		

Min. 780  
Max. 1020

Min. 170  
Max. 710

35°

150

**10-2708-21-21**  
**10-2708-AH-AH**  
LED OSTAR (OSRAM) 4,5W

Min. 300  
Max. 650

Min. 120  
Max. 670

150

**10-2709-21-21**  
**10-2709-AH-AH**  
LED OSTAR (OSRAM) 4,5W



# office

design \_ GROK Team

Estructura metálica disponible en acabados cromo y níquel satinado. Brazo basculante, cabezal orientable. Interruptor incluido. Luz directa.

Chrome or satin nickel body. Tilttable arm, adjustable head. Switch included. Direct light.

Structure métallique proposée avec finitions en nickel satiné et chromées. Bras à bascule, tête orientable. Interrupteur fourni. Lumière directe.

Metallgehäuse lieferbar in Chrom und satiniertem Nickel. Kipparm, verstellbares Kopfteil. Inkl. Schalter. Direkte Beleuchtung.

Struttura metallica disponibile con finitura cromata e nichel satinato. Braccio basculante, testina orientabile. Interruttore compreso. Luce diretta.

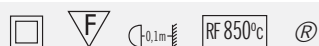

● Cromo  
● Chrome  
**21** Chrome  
● Chrom  
● Cromo

● Níquel Satinado  
● Satin nickel  
**81** Nickel satiné  
● Nickel matt  
● Nickel satinato

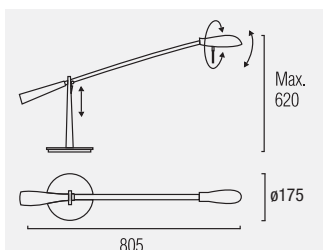

**10-0080-21-21**  
**10-0080-81-81**

G9 Max. 60W 230V  
HALOGEN OSRAM included



# totem mini

design \_ Josep Patsí

totem\_collection

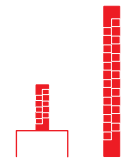

p.140 p.224

Estructura de aluminio en acabado satinado. Difusor acrílico opal. 2 interruptores independientes incorporados. Un interruptor enciende y apaga la luz principal; el otro enciende, apaga y cambia el color de la luz ambiente, permitiendo seleccionar entre 6 colores distintos así como el modo de cambio automático de color. Luz directa y luz de ambiente.

Satin aluminium body. Opal acrylic diffuser 2 independent switches incorporated. One switch turns the main light on /off; the other turns the ambient light on/off and changes the colour, selecting from 6 different colours as well as automatic colour-change mode. Direct and ambient light.

Structure en aluminium avec finitions satinées. Diffuseur acrylique opale. Deux interrupteurs incorporés indépendants : l'un allume et éteint la lumière principale, l'autre allume, éteint et change la couleur de la lumière d'ambiance (six couleurs différentes ainsi qu'un mode de changement automatique de la couleur). Lumière directe et lumière d'ambiance.

Gehäuse aus Aluminium mit satinierter Oberfläche. Diffusor Opal-Acryl. Mit 2 separaten Schaltern geliefert. Ein Schalter schaltet die Hauptlampe ein und aus, der zweite wählt und schaltet die Farbe des Ambientelechts. Auswahl zwischen 6 Farben möglich, sowie Modus zum automatischen Farbwechsel. Direkte Beleuchtung und Ambientebeleuchtung.

Struttura in alluminio, finitura lucida satinata. Diffusore acrilico opale. 2 interruttori indipendenti integrati. Un interruttore accende, spegne e regola la luce principale, mentre l'altro accende, spegne e cambia il colore della luce ambientale, consentendo di scegliere tra 6 diversi colori e la modalità di selezione automatica del colore. Luce diretta e luce ambientale.



## VERTICAL FLUORESCENT LIGHT



## LED COLOR CONTROL

Presionar para cambiar el color de los LEDs (6 colores). Incluye opción de cambio automático de color. Presionar durante 2 segundos para apagar los LEDs.  
Press to change the color of the LEDs (6 colors). Includes automatic color change. Pressing 2 seconds to switch off the LEDs.



- Aluminio satinado  
Satin aluminium  
**AF** Aluminium satiné  
Aluminium matt  
Alluminio satinato
- Difusor acrílico opal  
Opal acrylic diffuser  
**M1** Diffuseur acrilique opale  
Kunststoff - Reflektor  
Diffusore acrilico opalino

RGB color system with LEDs



## 10-2384-AF-M1

2G11 Max. 24W  
ENERGY SAVING included

36 LEDs RGB COLOR SYSTEM



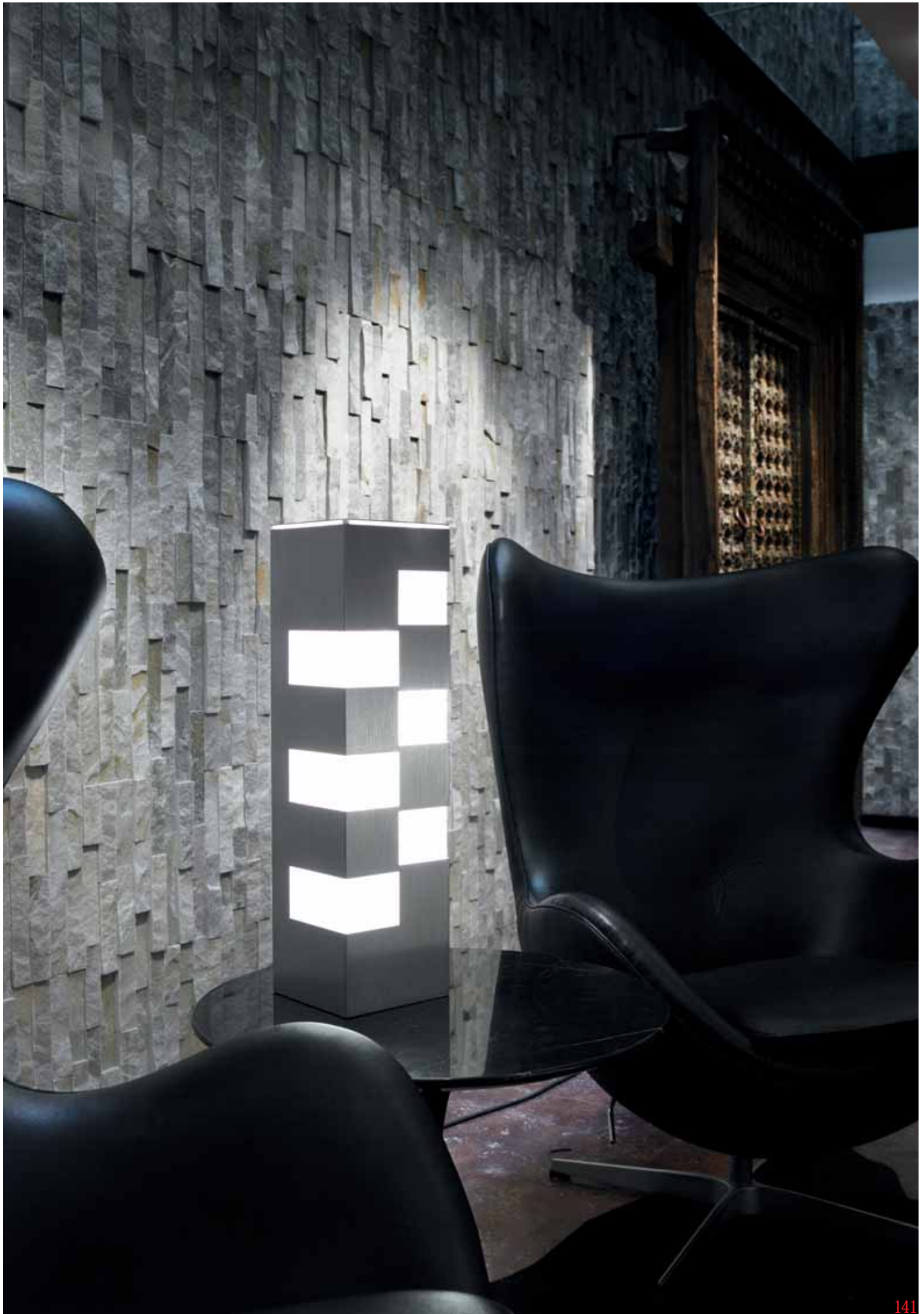



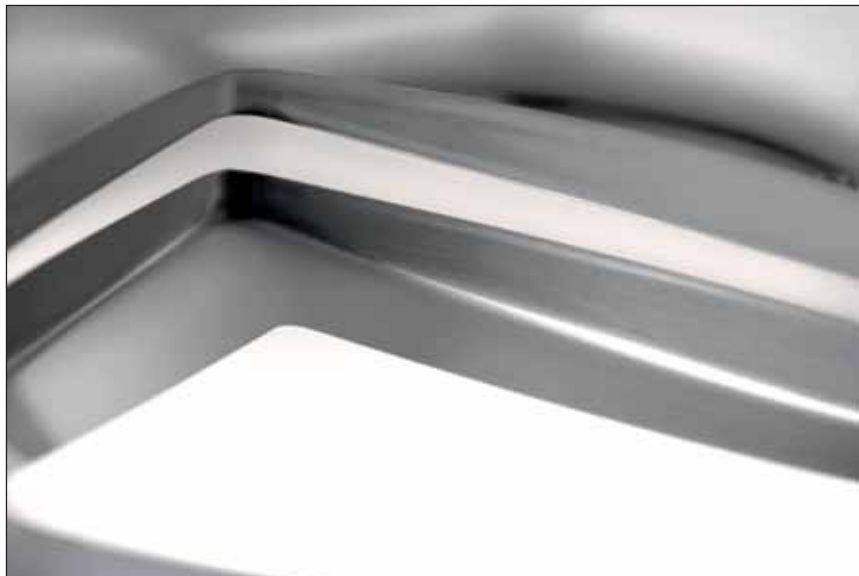

\_plafones  
\_ceiling fixtures  
\_plafoniers  
\_deckenleuchten  
\_plafoniere

slight\_144

nemo\_148

traç\_150

troppo\_152

escher\_156

ona\_158

ocho\_162

adagio\_166

basic\_168

square\_172

ibis\_174

diana\_176

moon\_177

mini\_178

ska\_182

quattro\_184

slimm\_186

adn\_188

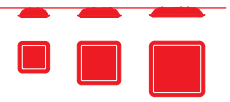

Estructura metálica cuadrada en acabado cromo. Difusor de cristal opal matizado. Disponible en 3 tamaños diferentes. Luz directa e indirecta.

Square metallic body in chrome finish. Matte opal glass diffuser. Available in 3 sizes. Direct and indirect light.

Structure métallique carrée avec finitions chromées. Diffuseur en verre opale teinté. Existe en trois tailles. Lumière directe et indirecte.

Quadratisches Gehäuse aus verchromtem Metall. Diffusor aus mattiertem Opalglas. In 3 Größen lieferbar. Zur direkten und indirekten Beleuchtung.

Struttura metallica quadrata con finitura cromata. Diffusore in cristallo opale opacizzato. Disponibile in 3 diverse misure. Luce diretta e indiretta.



		RF 850°C	®
	<span style="background-color: #0056b3; color: white; border-radius: 50%; padding: 2px 5px;">new</span>		
FE	GLASS OPAL3		
Cromo Chrome <b>21</b> Chrome Chrom Cromo	Cristal opal triplex Triplex Opal glass <b>F9</b> Verre opal triplex Optishes Glas Vetro ottico		

**15-4318-21-F9**  
R7s L=118 Max. 230W  
HALOGEN  
OSRAM included

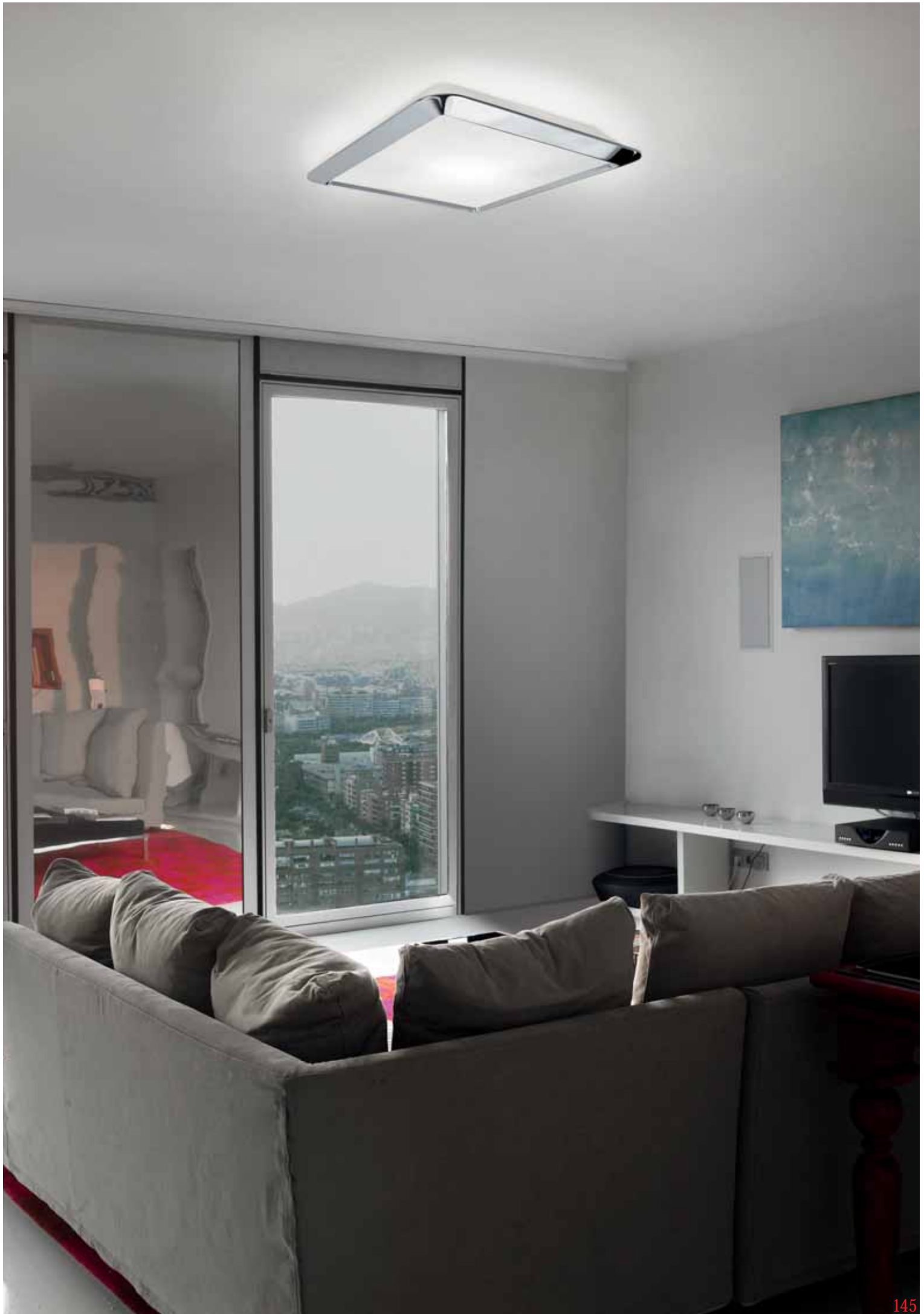



slight

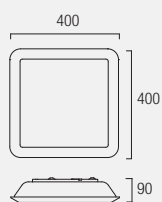

**15-4316-21-F9**  
R7s L=118 Max. 160W  
HALOGEN OSRAM  
included

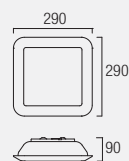

**15-4314-21-F9**  
R7s L=78 Max. 120W  
HALOGEN OSRAM  
included

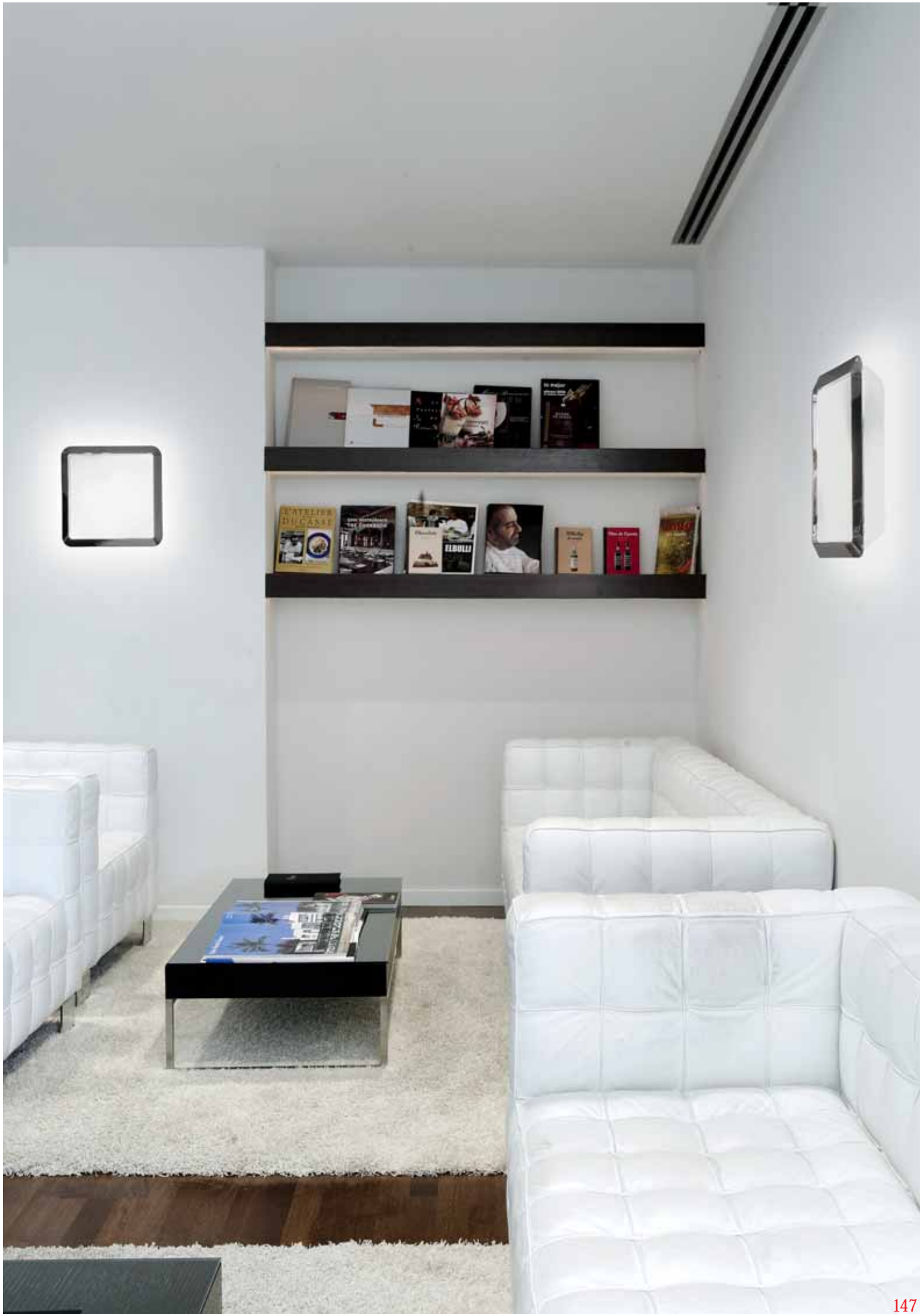

Estructura metálica en acabado cromo. Difusor de cristal opal triplex. Luz directa e indirecta.

Chrome metal body. Triplex optical glass diffuser. Direct and indirect light.

Structure métallique avec finitions chromées. Diffuseur en verre opale triplex. Lumière directe et indirecte.

Gehäuse aus verchromtem Metall. Diffusor aus Triplex-Opalglas. Zur direkten und indirekten Beleuchtung.

Struttura metallica con finitura cromata. Diffusore in cristallo opale triplex. Luce diretta e indiretta.



		RF 850°C	
ZAMAK	GLASS OPAL3		
<p> Cromo</p> <p><b>21</b> Chrome</p> <p>Chrom</p> <p>Cromo</p>	<p> Cristal opal triplex</p> <p><b>F9</b> Verre opal triplex</p> <p>Optishes Glas</p> <p>Vetro ottico</p>		

**15-4332-21-F9**  
 R7s L=78 Max. 100W  
 HALOGEN OSRAM included





Estructura de aluminio Ecobright. Reflector metálico disponible en 2 acabados, blanco y pan de plata. Luz principalmente indirecta y en parte directa gracias al difusor de cristal anti-deslumbrante.

Ecobright aluminium body. Metal reflector available in 2 finishes: white and silver leaf. Mainly indirect light and some direct light thanks to an anti-glare glass diffuser.

Structure en aluminium Ecobright. Réflecteur métallique proposé avec deux finitions (en blanc et en argenté). Lumière principalement indirecte, partiellement directe à travers son diffuseur en verre antireflets.

Gehäuse aus Ecobright-Aluminium. Reflektor aus Metall, lieferbar in 2 Ausführungen: weiß und silberfolie. Direkte Beleuchtung und auch indirekte Beleuchtung durch Diffusor aus entspiegeltem Glas.

Struttura in alluminio Ecobright. Riflettore metallico disponibile in 2 finiture, bianco e foglia d'argento. Luce principalmente indiretta e parzialmente diretta, grazie al diffusore in cristallo anti-abbagliamento.



		RF 850°C	
AL	FE	GLASS MAT	
<ul style="list-style-type: none"> <li>○ Blanco</li> <li>○ White</li> <li><b>AH</b> Blanc</li> <li>Weiss</li> <li>Bianco</li> </ul>	<ul style="list-style-type: none"> <li>● Pan de plata</li> <li>● Silver leaf</li> <li><b>D9</b> Feuille d'argent</li> <li>Blattsilber</li> <li>Foglia argento</li> </ul>		
○	Cristal anti-deslumbrante		
	Anti-glare glass		
<b>F1</b>	Verre antiéblouissante		
	Blendfreies Glas		
	Vetro antiriflesso		

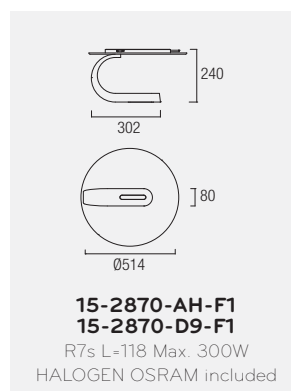





# tropo

design\_ Benedito Design

tropo\_collection

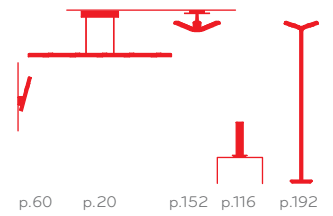

Estructura con 3 brazos de aluminio en acabado cromo. Cristales de borosilicato matizado. Emite luz directa y también indirecta gracias a las aperturas de la parte superior de la estructura.

Chrome aluminium body with 3 arms. Matte borosilicate glass. Provides direct and indirect light thanks to openings at the top of the luminaire.

Structure avec trois bras en aluminium avec finitions chromées. Verre borosilicate teinté. Émet une lumière directe mais aussi indirecte grâce aux ouvertures de la partie supérieure de la structure.

Gehäuse mit 3 Armen aus Aluminium, Oberfläche verchromt. Mattes Borosilikatglas. Direkte Beleuchtung sowie indirekte Beleuchtung durch die Öffnungen an der Oberseite der Leuchte.

Struttura con 3 bracci in alluminio con finitura cromata. Cristalli di borosilicato opacizzato. Emette luce diretta e indiretta, anche grazie alle aperture della parte superiore della struttura.

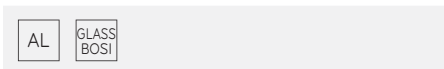
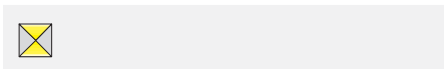

- Cromo
- Cristal anti-deslumbrante
- 21 Chrome
- F1 Verre antiéblouissante
- Chrom
- Blendfreies Glas
- Cromo
- Vetro antiriflesso

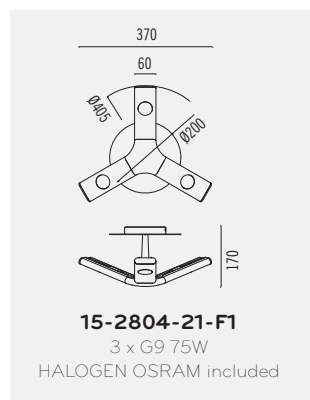

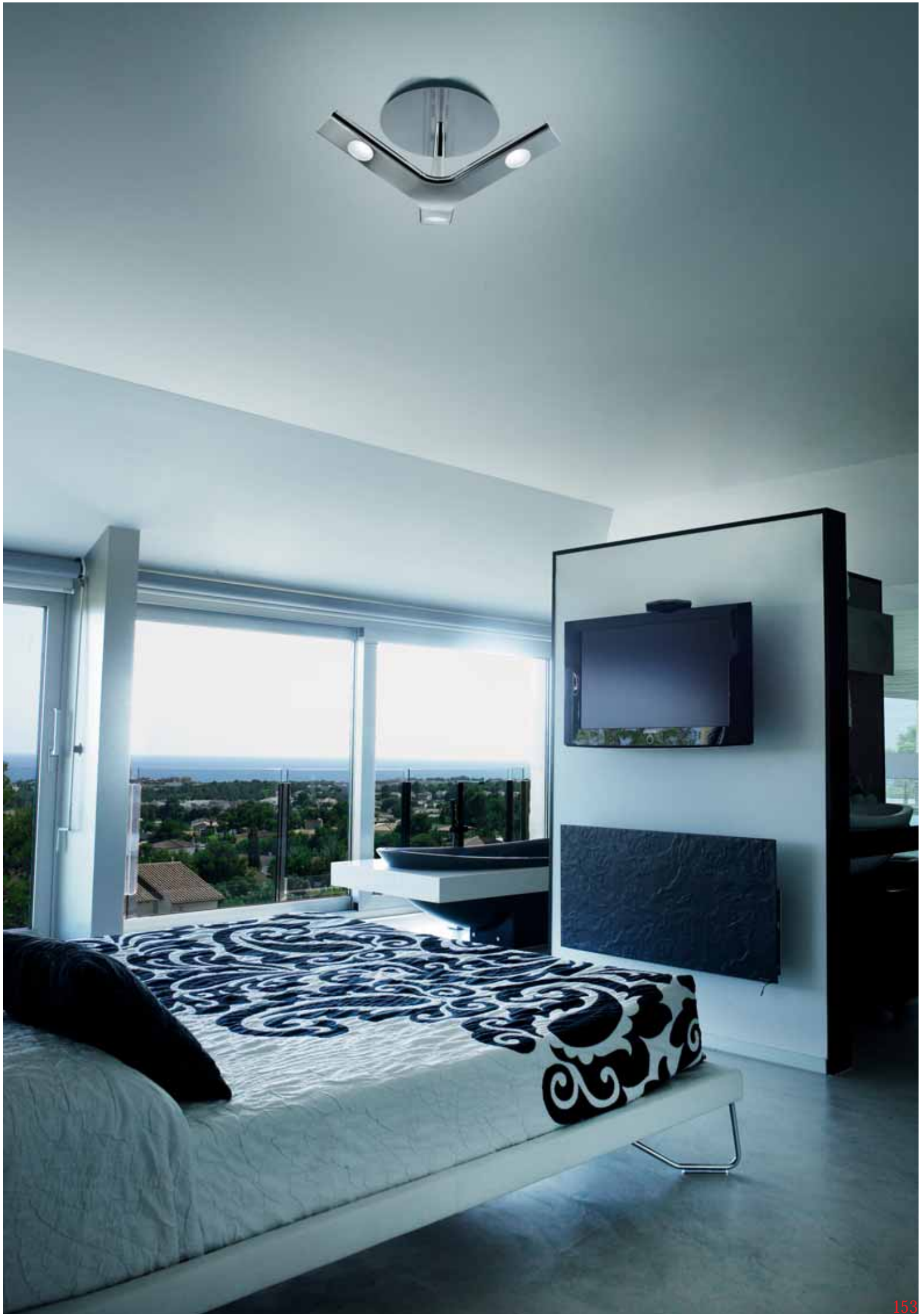









# escher

design \_ Josep Patsí

escher\_collection

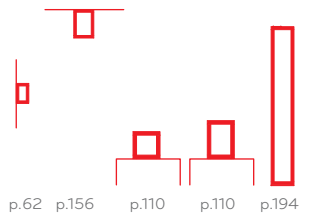

Estructura metálica en 3 acabados disponibles: aluminio Ecobright, lacado blanco y lacado negro. Luz indirecta.

Metal body available in 3 finishes: Ecobright, black lacquer or white lacquer. Indirect light.

Structure métallique proposée avec trois finitions: aluminium Ecobright, verni blanc et verni noir. Lumière indirecte.

Metallgehäuse in 3 Ausführungen lieferbar: Ecobright-Aluminium, weiß lackiert und schwarz lackiert. Indirekte Beleuchtung.

Struttura metallica disponibile con 3 finiture: alluminio Ecobright, laccato bianco e laccato nero. Luce indiretta.

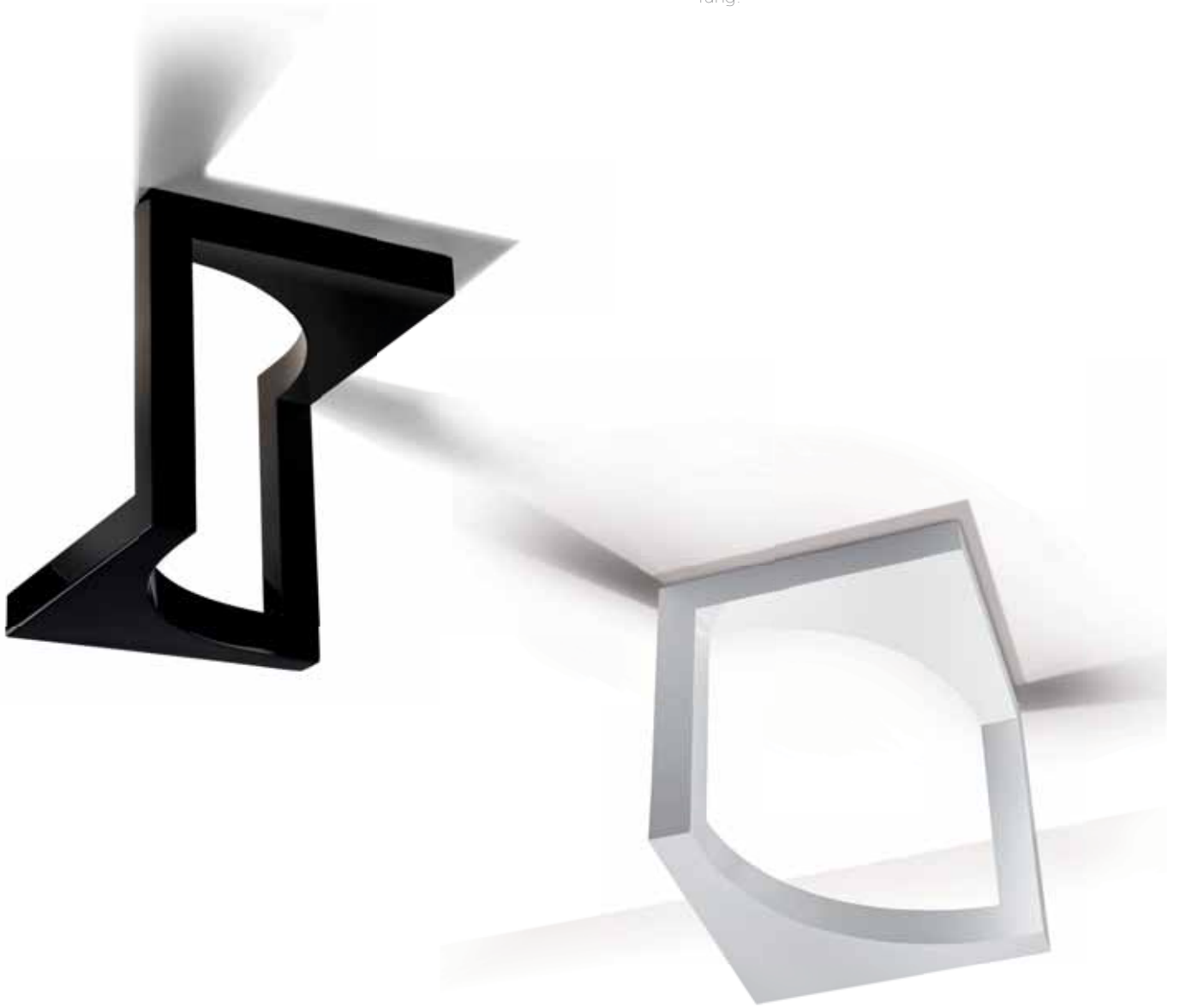

FE

● Aluminio Ecobright  
Ecobright aluminium  
**AH** Aluminium Ecobright  
Ecobright aluminium  
Alluminio Ecobright

● Lacado negro  
Black lacquered  
**05** Laqué en noir  
Schwarz lackiert  
Laccato nero

○ Lacado blanco  
White lacquered  
**78** Laqué en blanc  
Weiss lackiert  
Laccato bianco

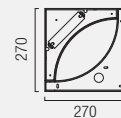
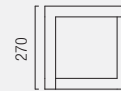

**15-2782-AH-AH**  
**15-2782-05-05**  
**15-2782-78-78**

R7s L=118 Max. 300W  
HALOGEN OSRAM included

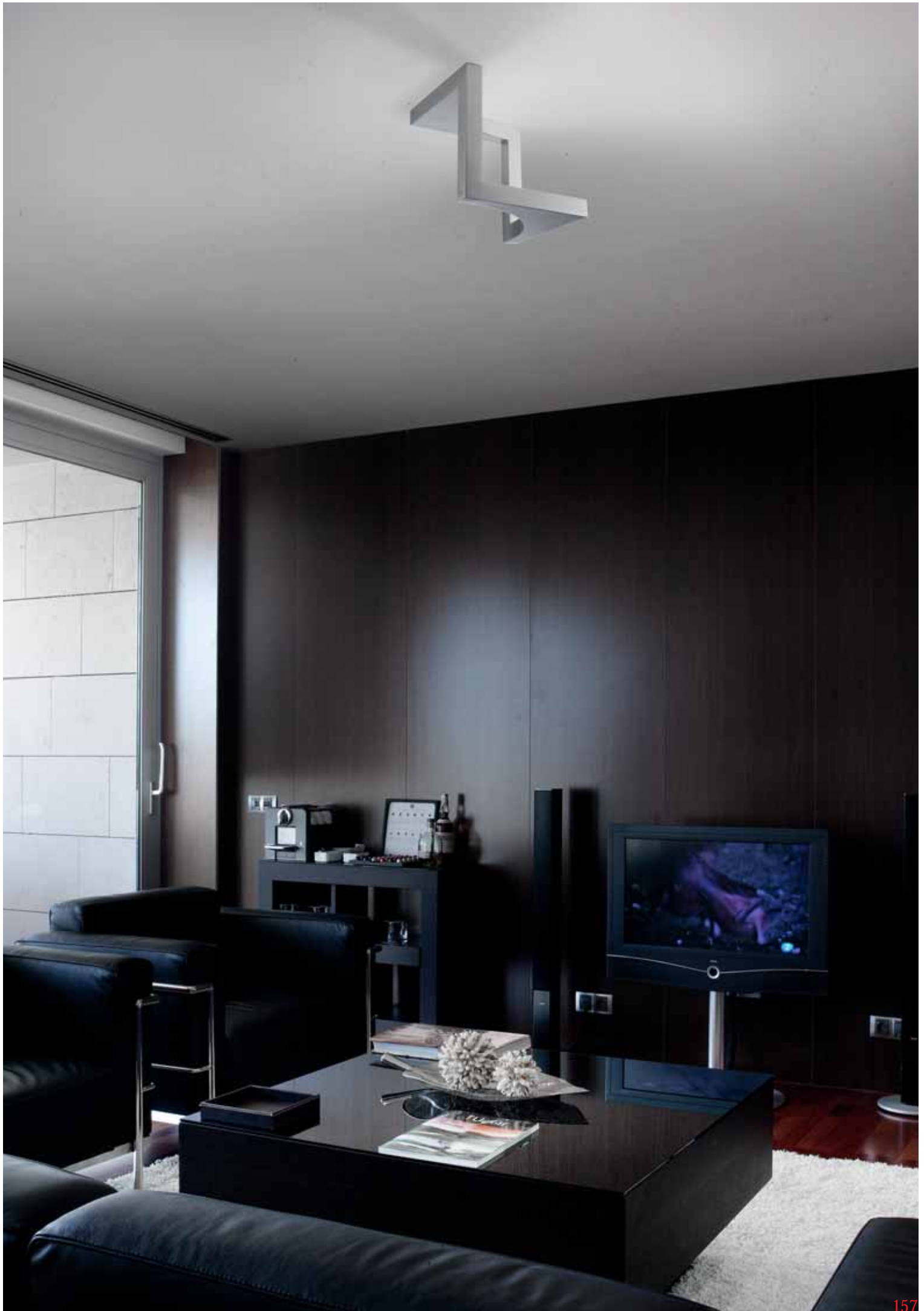



Estructura de aluminio pulido y satinado. Difusor de metacrilato matizado. Disponible en 3 tamaños: 44cm, 60cm y 80cm. Luz directa.

Polished and satin aluminium body. Matte methacrylate diffuser. Available in 3 sizes: 44cm, 60cm and 80cm. Direct light.

Structure en aluminium poli et satiné. Diffuseur en méthacrylate teinté. Proposée en trois largeurs: 44 cm, 60 cm et 80 cm. Lumière directe.

Gehäuse aus poliertem und satiniertem Aluminium. Diffusor aus mattiertem Plexiglas. In 3 Größen lieferbar: 44 cm, 60 cm und 80 cm. Direkte Beleuchtung.

Struttura in alluminio, lucido satinato. Diffusore in metacrilato opacizzato. Disponibile in 3 misure: 44 cm, 60 cm e 80 cm. Luce diretta.

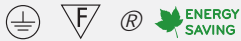

● Aluminio pulido y satinado  
Polished and burnished aluminium  
**S2** Aluminium poli et satiné  
Aluminium poliert und mattglänzend  
Alluminio lucidato e satinato

○ Difusor policarbonato opal  
Opal polycarbonate diffuser  
**M1** Diffusore polycarbonato opale  
Polykarbonatdiffusor Opal  
Diffusore in policarbonato opalino

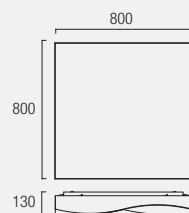

**15-2781-S2-M1**  
2G11 4x55W  
ENERGY SAVING  
included

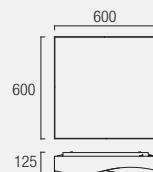

**15-2780-S2-M1**  
2G11 4x36W  
ENERGY SAVING  
included



**15-2779-S2-M1**  
T5 FC 22W+40W  
ENERGY SAVING  
included



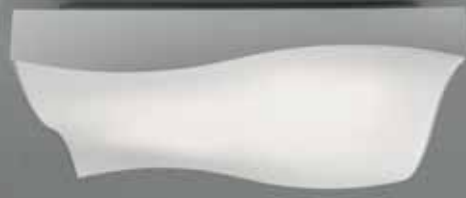







Estructura de poliuretano en acabado blanco mate. Difusor de metacrilato matizado. Disponible en versión de una, dos y cuatro luces, ésta última con sistema de doble iluminación independiente. Luz directa.

Matte-white polyurethane body. Matte methacrylate diffuser. Available in one, two or four lamp versions. Four-lamp version with independent double lighting system. Direct light.

Structure en polyuréthane avec finitions en blanc mat. Diffuseur en méthacrylate teinté. Proposée en déclinaisons d'une, deux et quatre lumières, cette dernière incluant un système de double éclairage indépendant. Lumière directe.

Gehäuse aus Polyurethan, Oberfläche mattweiß. Diffusor aus mattiertem Plexiglas. Lieferbar mit einer, zwei und vier Lampen. 4er Ausführung mit unabhängiger Doppelbeleuchtung. Direkte Beleuchtung.

Struttura in poliuretano con finitura bianco opaco. Diffusore in metacrilato opacizzato. Disponibile in versione da una, due e quattro luci. Quest'ultima è dotata di un sistema a doppia illuminazione indipendente. Luce diretta.

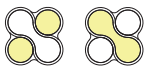

Sistema de doble iluminación independiente  
Independent double lighting system



- |                                    |  |
|------------------------------------|--|
| ○ Blanco<br>White                  | ○ Difusor policarbonato opal<br>Opal polycarbonate diffuser  |
| <b>14</b> Blanc<br>Weiss<br>Bianco | <b>M1</b> Diffuseur polycarbonate opale<br>Polykarbonatdiffusor Opal<br>Diffusore in policarbonato opalino |

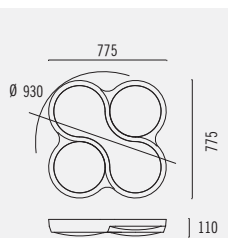

**15-2807-14-M1**  
4 x 2GX13 55W  
FLUORESCENT included





$\varnothing$  410  
 $\varnothing$  340  
84

**15-2805-14-M1**  
2GX13 55W  
FLUORESCENT included

930  
410  
 $\varnothing$  410  
85

**15-2806-14-M1**  
2 x 2GX13 55W  
FLUORESCENT included





# adagio

design \_ Josep Patsí

adagio\_collection

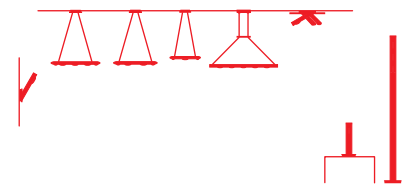

p.68 p.38 p.39 p.38 p.36 p.166 p.118 p.209

Estructura con 3 brazos de aluminio y difusores de cristal anti-deslumbrante. Disponible en acabados cromo y aluminio pulido satinado. Emite luz directa y también indirecta gracias a las aperturas en la parte posterior de los brazos.

Aluminium body with 3 arms and anti-glare glass diffusers. Available in chrome or polished and satin aluminium. Provides direct and indirect light thanks to openings on the back of the arms.

Structure dotée de trois bras en aluminium et diffuseurs en verre antireflets. Proposée avec des finitions chromées et en aluminium poli satiné. Émet une lumière directe mais aussi indirecte grâce aux ouvertures derrière les bras.

Gehäuse mit 3 Armen aus Aluminium und Diffusore aus entspiegeltem Glas. Verchromt und in poliertem satiniertem Aluminium lieferbar. Direkte Beleuchtung sowie indirekte Beleuchtung durch die Öffnungen an der Rückseite der Arme.

Struttura con 3 bracci in alluminio e diffusori in cristallo anti-abbagliamento. Disponibile con finitura in cromo e alluminio lucido satinato. Emette luce diretta e indiretta, anche grazie alle aperture nella parte posteriore dei bracci.



- Cromo  
21 Chrome  
Chrom  
Cromo
- Aluminio pulido y satinado  
S3 Polished and burnished aluminium  
Aluminium poli et satiné  
Aluminium poliert und mattglänzend  
Alluminio lucidato e satinato

- Cristal anti-deslumbrante  
F1 Anti-glare glass  
Verre antiéblouissante  
Blendfreies Glas  
Vetro antiriflesso



15-0221-21-F1  
15-0221-S3-F1

3 x G9 Max. 75W 230V  
HALOGEN OSRAM included

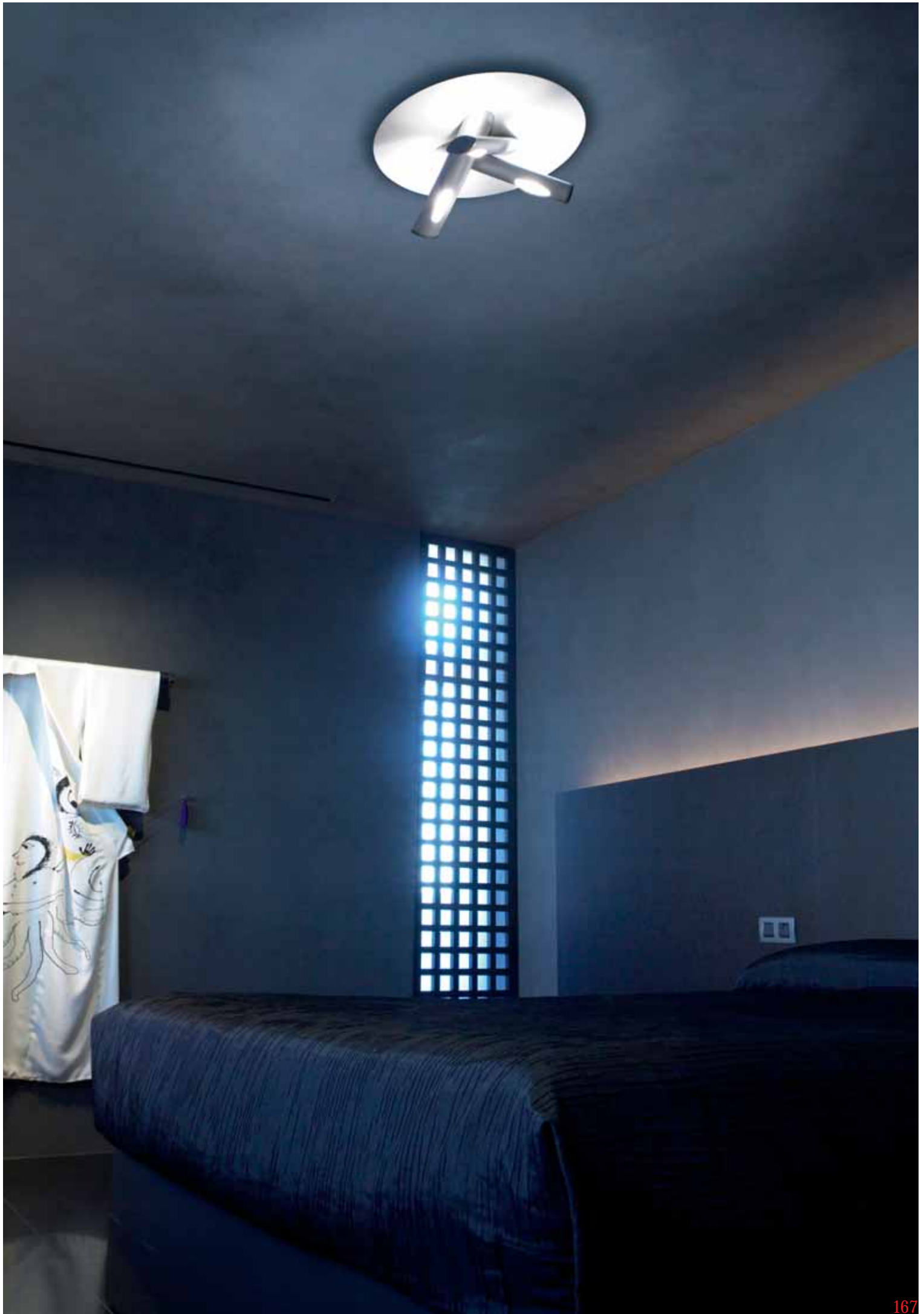

# basic

design \_ Josep Patsí

basic\_collection



p.168 p.168 p.168 p.171 p.171 p.171 p.170 p.170

Estructura metálica. Difusor de cristal óptico. 3 versiones con difusor circular y 3 versiones con difusor cuadrado, disponibles en cromo y en níquel satinado. Luz directa e indirecta.

Metal body. Optical glass diffuser. 3 different size versions with circular diffuser and 3 different size versions with square diffuser, available in chrome and satin nickel. Direct and indirect light.

Structure métallique. Diffuseur en verre optique. Trois versions dotées d'un diffuseur circulaire, et trois autres versions avec diffuseur carré, proposées en chrome et en nickel satiné. Lumière directe et indirecte.

Metallgehäuse. Diffusor aus mattem Optikglas. 3 Ausführungen mit kreisförmigem Diffusor, in verschiedenen Größen, alle verchromt. 3 Ausführungen mit quadratischem Diffusor, in verschiedenen Größen, und die 2 quadratischen. Zur direkten und indirekten Beleuchtung.

Struttura metallica. Diffusore in cristallo ottico. 3 versioni con diffusore circolare, et 3 versioni con diffusore quadrato, disponibili in cromo e in nichel satinato. Luce diretta e indiretta.

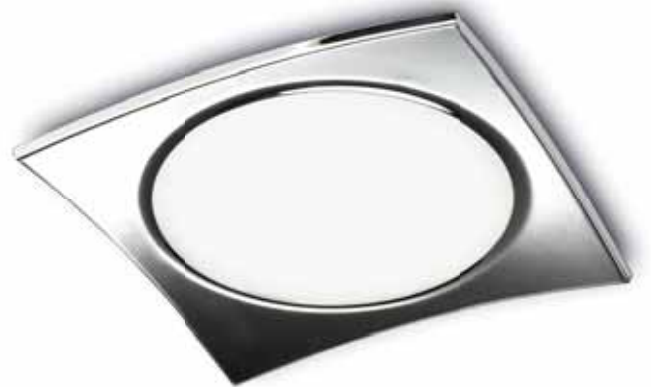
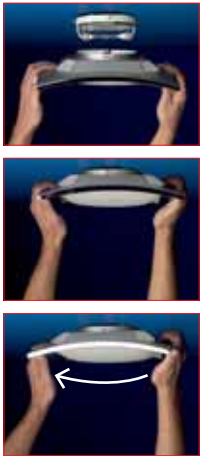

- Cromo  
21 Chrome  
Chrom  
Cromo
- Níquel Satinado  
81 Satin nickel  
Nickel satiné  
Nickel matt  
Nichel satinato

- Cristal óptico  
E9 Optic glass  
Verre optique  
Optisches Glas  
Vetro ottico

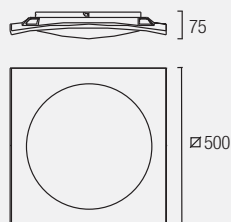

**15-2393-21-E9 (S)**  
R7s L=118 Max. 300W  
HALOGEN OSRAM included

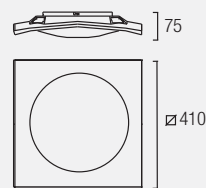

**15-2391-21-E9**  
R7s L=118 Max. 200W  
HALOGEN OSRAM included

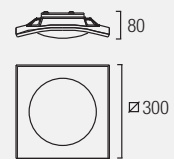

**15-2390-21-E9**  
R7s L=78 Max. 150W  
HALOGEN OSRAM included



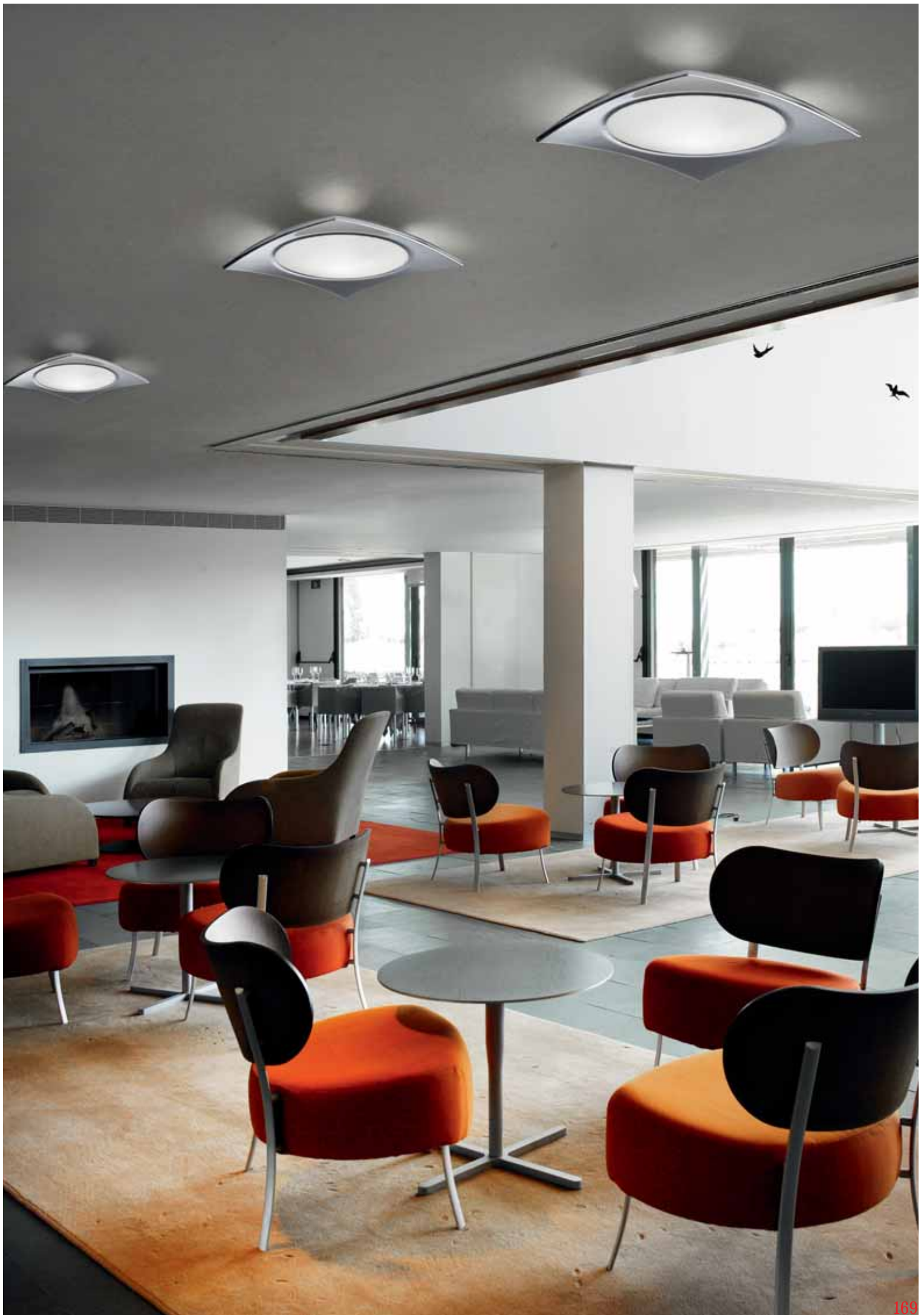



VISTA LATERAL 15-2388  
SIDE VIEW 15-2388



VISTA LATERAL 15-2389  
SIDE VIEW 15-2389

**15-2388-21-B9**  
**15-2388-81-B9**  
R7s L=118 Max. 300W  
HALOGEN OSRAM included

**15-2389-21-B9**  
4 x 2G11 Max. 24W  
ENERGY SAVING included



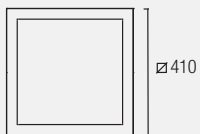

**15-2386-21-B9**  
**15-2386-81-B9**  
 R7s L=118 Max. 200W  
 HALOGEN OSRAM included

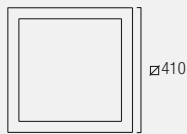

**15-2387-21-B9**  
 4 x 2G11 Max. 18W  
 ENERGY SAVING included



Elect.  
inc.

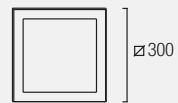

**15-2385-21-B9**  
**15-2385-81-B9**  
 R7s L=78 Max. 150W  
 HALOGEN OSRAM included



# square

design \_ Toni Dias

square\_collection



Estructura cuadrada de aluminio pulido y satinado. Difusor acrílico opal. Disponible en 3 tamaños diferentes. Luz directa.

Square polished and satin aluminium body. Opal acrylic diffuser Available in 3 sizes. Direct light.

Structure carrée en aluminium poli et satiné. Diffuseur acrylique opale. Existe en trois tailles. Lumière directe.

Quadratisches Gehäuse aus poliertem und satinier-tem Aluminium. Diffusor Opal-Acryl. In 3 Größen lieferbar. Direkte Beleuchtung.

Struttura quadrata in alluminio, lucido satinato. Diffusore acrilico opale. Disponibile in 3 diverse misure. Luce diretta.

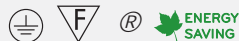

**S2** ● Aluminio pulido y satinado  
Polished and burnished aluminium  
Aluminium poli et satiné  
Aluminium poliert und mattglänzend  
Alluminio lucidato e satinato

**M1** ○ Difusor acrílico opal  
Opal acrylic diffuser  
Diffuseur acrylique opale  
Kunststoff - Reflektor  
Diffusore acrilico opalino

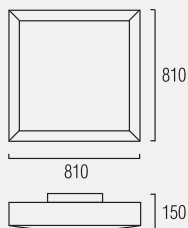

**15-0592-S2-M1**  
4 x 2G11 55W  
ENERGY SAVING included

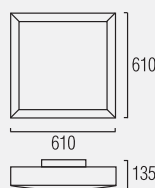

**15-0591-S2-M1**  
4 x 2G11 36W  
ENERGY SAVING included

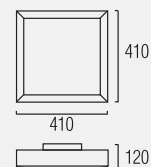

**15-0590-S2-M1**  
4 x 2G11 18W  
ENERGY SAVING included

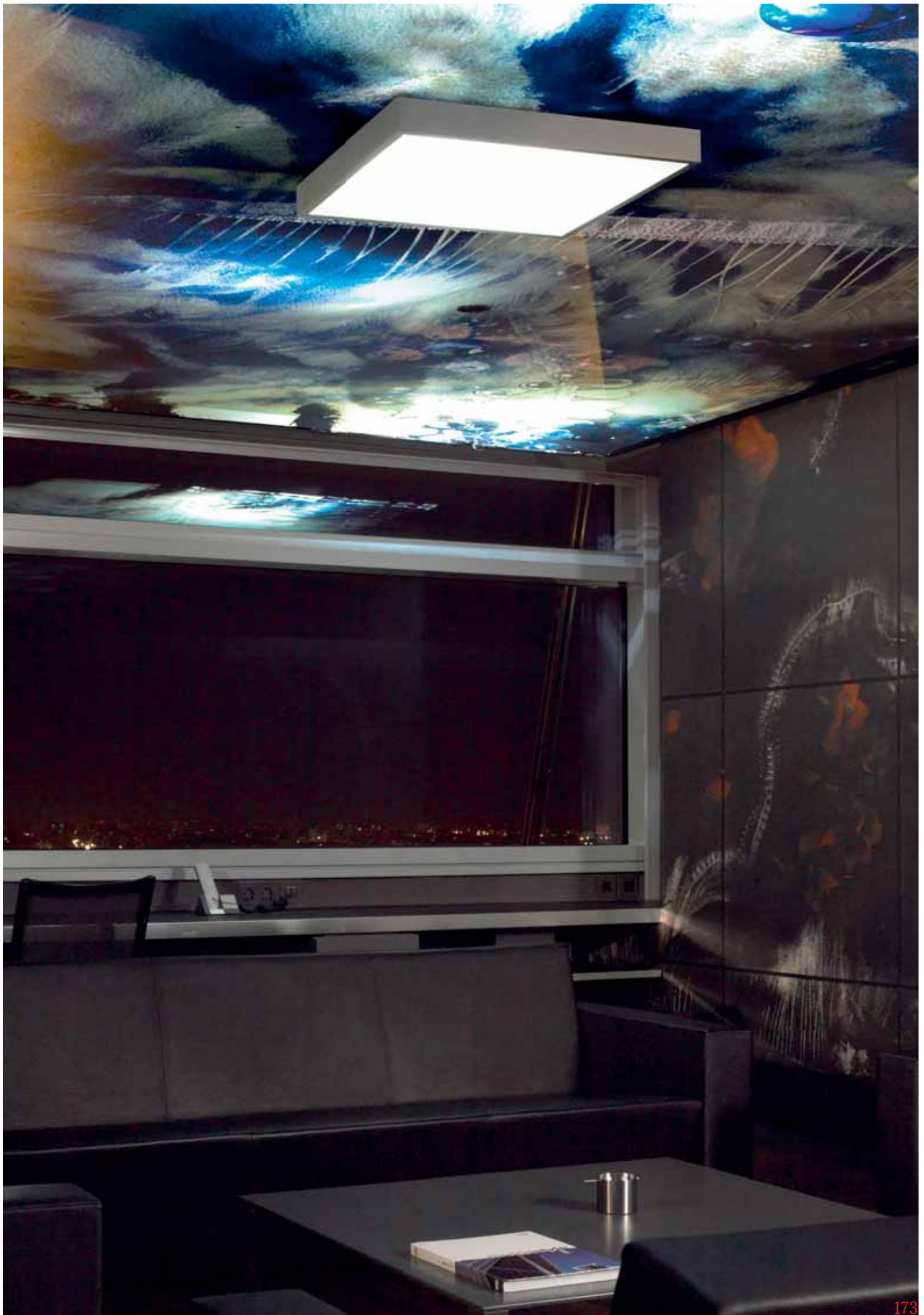



Estructura metálica en acabado níquel satinado y reflector de color blanco. Disponible en 4 tamaños diferentes. Luz indirecta.

Satin nickel body and white reflector. Available in 4 sizes. Indirect light.

Structure métallique avec finitions en nickel satiné et un réflecteur blanc. Existe en quatre tailles. Lumière indirecte.

Metallgehäuse in satiniertem Nickel und Reflektor in Weiß. In 4 Größen lieferbar. Indirekte Beleuchtung.

Struttura metallica con finitura nichel satinata e riflettore in colore bianco. Disponibile in 4 diverse misure. Luce indiretta.



FE		
<p>● Níquel Satinado Satin nickel</p> <p><b>81</b> Nickel satiné Nickel matt Nichel satinato</p>		

**IBIS C/47-81**  
R7s L=118 Max. 300W  
HALOGEN OSRAM  
included

**IBIS C/37-81**  
R7s L=118 Max. 200W  
HALOGEN OSRAM  
included

**IBIS C/27-81**  
R7s L=78 Max. 150W  
HALOGEN OSRAM  
included

**IBIS C/17-81**  
G9 Max. 75W 230V  
HALOGEN OSRAM  
included

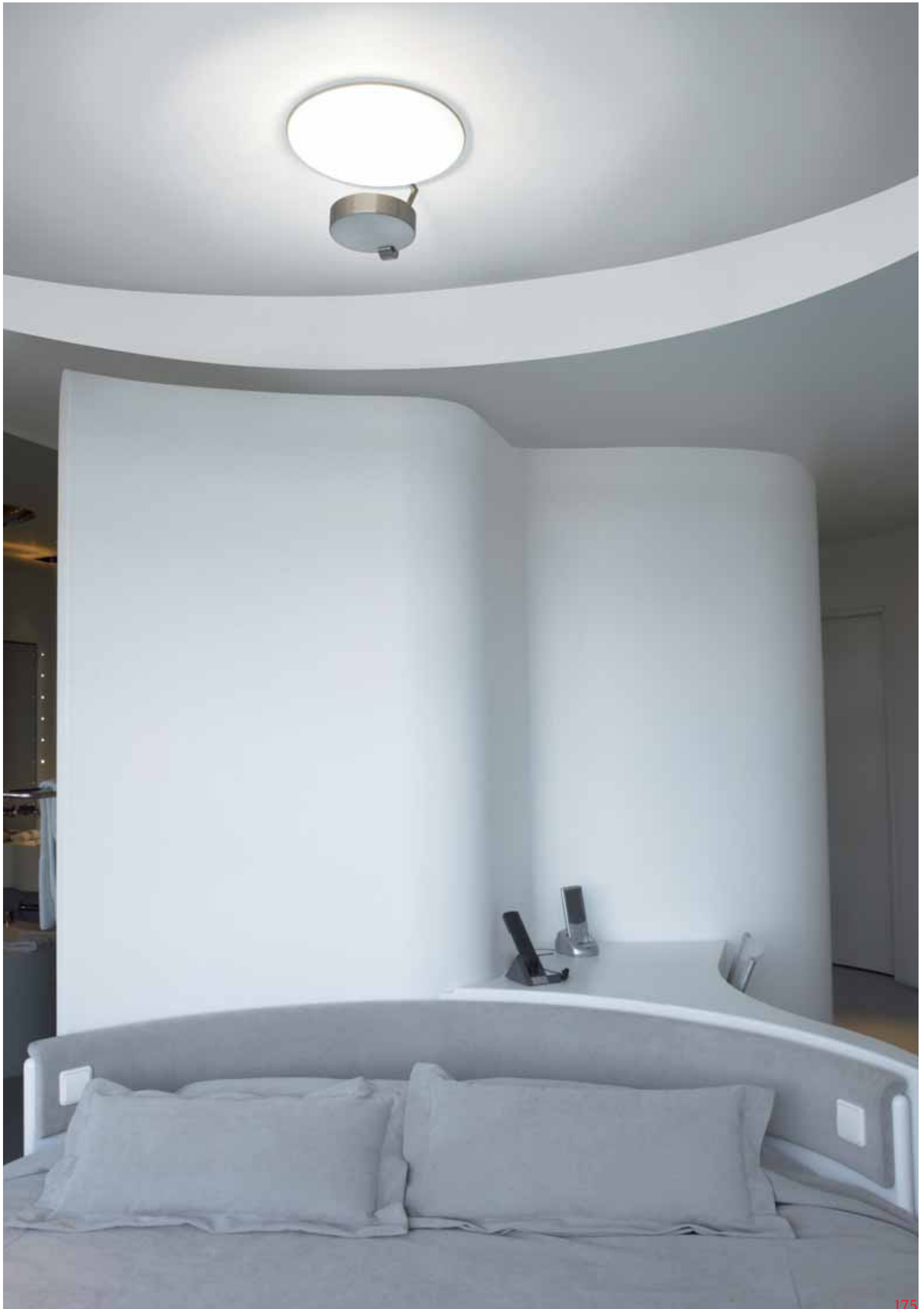



# diana

design \_ Benedito Design

Estructura de aluminio disponible en acabados cromo y níquel satinado. Difusor de vidrio templado extrablanco. Luz directa e indirecta.

Aluminium body available in chrome or satin nickel. Extra-white tempered glass diffuser. Direct and indirect light.

Structure en aluminium proposée avec finitions chromées et en nickel satiné. Diffuseur en verre délicat extra blanc. Lumière directe et indirecte.

Aluminiumgehäuse lieferbar in Chrom und satinier-tem Nickel. Diffusor aus extraweißem Milchglas. Zur direkten und indirekten Beleuchtung.

Struttura in alluminio disponibile con finitura cromata e nichel satinato. Diffusore in vetro temperato extrabianco. Luce diretta e indiretta.



- |                  |                         |
|------------------|-------------------------|
| ● Cromo          | ● Níquel Satinado       |
| ● Chrome         | ● Satin nickel          |
| <b>21</b> Chrome | <b>81</b> Nickel satiné |
| ● Chrom          | ● Nickel matt           |
| ● Cromo          | ● Nichel satinato       |

- |                                       |
|---------------------------------------|
| ○ Vidrio templado extrablanco         |
| ○ Extra white tempered glass          |
| <b>E9</b> Verre tempérant extra blanc |
| ○ Ätzmattes neutral Glas gehärtet     |
| ○ Vetro extra bianco temperato        |

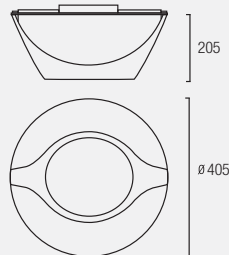

**15-0562-21-E9**  
**15-0562-81-E9**  
 R7s L=118 Max. 300W  
 HALOGEN OSRAM included



Estructura de aluminio y reflector de hierro. Disponibles 2 versiones: una en acabado cromo con reflector acabado en aluminio mate y otra en acabado níquel satinado con reflector blanco. Luz indirecta y parcialmente directa.

Aluminium body and iron reflector. Available in 2 versions: chrome finish with matte aluminium reflector and satin nickel finish with white reflector. Indirect and partial direct light.

Structure en aluminium et réflecteur en fer. Existe en deux déclinaisons : l'une présente des finitions en chrome, livrée avec son réflecteur avec finitions en aluminium mat, et l'autre possède des finitions en nickel satiné, avec réflecteur blanc. Lumière indirecte et partiellement directe.

Aluminiumgehäuse und Reflektor aus Eisen. In zwei Ausführungen lieferbar: Ausführung mit verchromter Oberfläche mit Reflektor in mattem Aluminium oder mit Oberfläche in satiniertem Nickel mit weißem Reflektor. Indirekte Beleuchtung und teilweise direkte Beleuchtung.

Struttura in alluminio e riflettore in ferro. Disponibile in 2 versioni: una con finitura cromata e riflettore con finitura in alluminio opaco e l'altra con finitura in nichel satinato con riflettore in colore bianco. Luce indiretta e parzialmente diretta.



Cromo Chrome	Níquel Satinado Satin nickel		
<b>21</b> Chrom Chrom Cromo	<b>81</b> Nickel satiné Nickel matt Nichel satinato		

**15-2138-21-21**  
**15-2138-81-81**  
R7s L=118 Max. 200W  
HALOGEN OSRAM included



# mini

design \_ Josep Patsí

mini\_collection



p.178 p.178 p.180 p.180

Estructura metálica en acabado níquel satinado. Difusor frontal de cristal óptico y perimetral de policarbonato. Disponible en 2 tamaños, ambos en versión cuadrada y circular. Luz directa e indirecta.

Satin nickel metal body. Front optical glass diffuser and polycarbonate perimeter. Available in 2 sizes, both in square and circular versions. Direct and indirect light.

Structure métallique avec finitions en nickel satiné. Diffuseur frontal en verre optique et diffuseur périmétral en polycarbonate. Existe en deux tailles et en déclinaisons. Lumière directe et indirecte.

Metallgehäuse in satiniertem Nickel. Diffusor an Vorderseite aus Optikglas und Diffusor rund um die Leuchte aus Polycarbonat. In 2 Größen lieferbar, beide quadratisch und kreisförmig. Zur direkten und indirekten Beleuchtung.

Struttura metallica con finitura nichel satinato. Diffusore frontale in cristallo ottico e perimetrale in polycarbonato. Disponibile in 2 versioni, entrambe in versione quadrata e circolare. Luce diretta e indiretta.

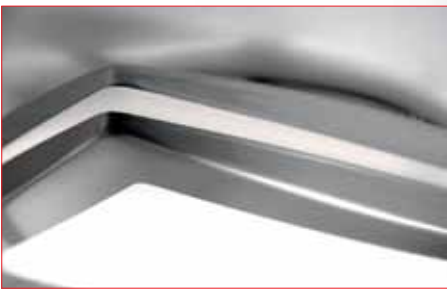

● Níquel Satinado  
Satin nickel  
**81** Nickel satiné  
Nickel matt  
Nichel satinato

○ Cristal óptico  
Optic glass  
**E9** Verre optique  
Optishes Glas  
Vetro ottico

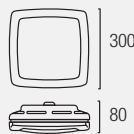

**15-0258-81-E9**  
R7s L=118 Max. 200W  
HALOGEN OSRAM included



**15-0223-81-E9**  
R7s L=78 Max. 100W  
HALOGEN OSRAM included



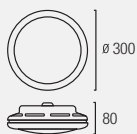

**15-0256-81-E9**  
R7s L=118 Max. 200W  
HALOGEN OSRAM included



**15-0222-81-E9**  
R7s L=78 Max. 100W  
HALOGEN OSRAM included



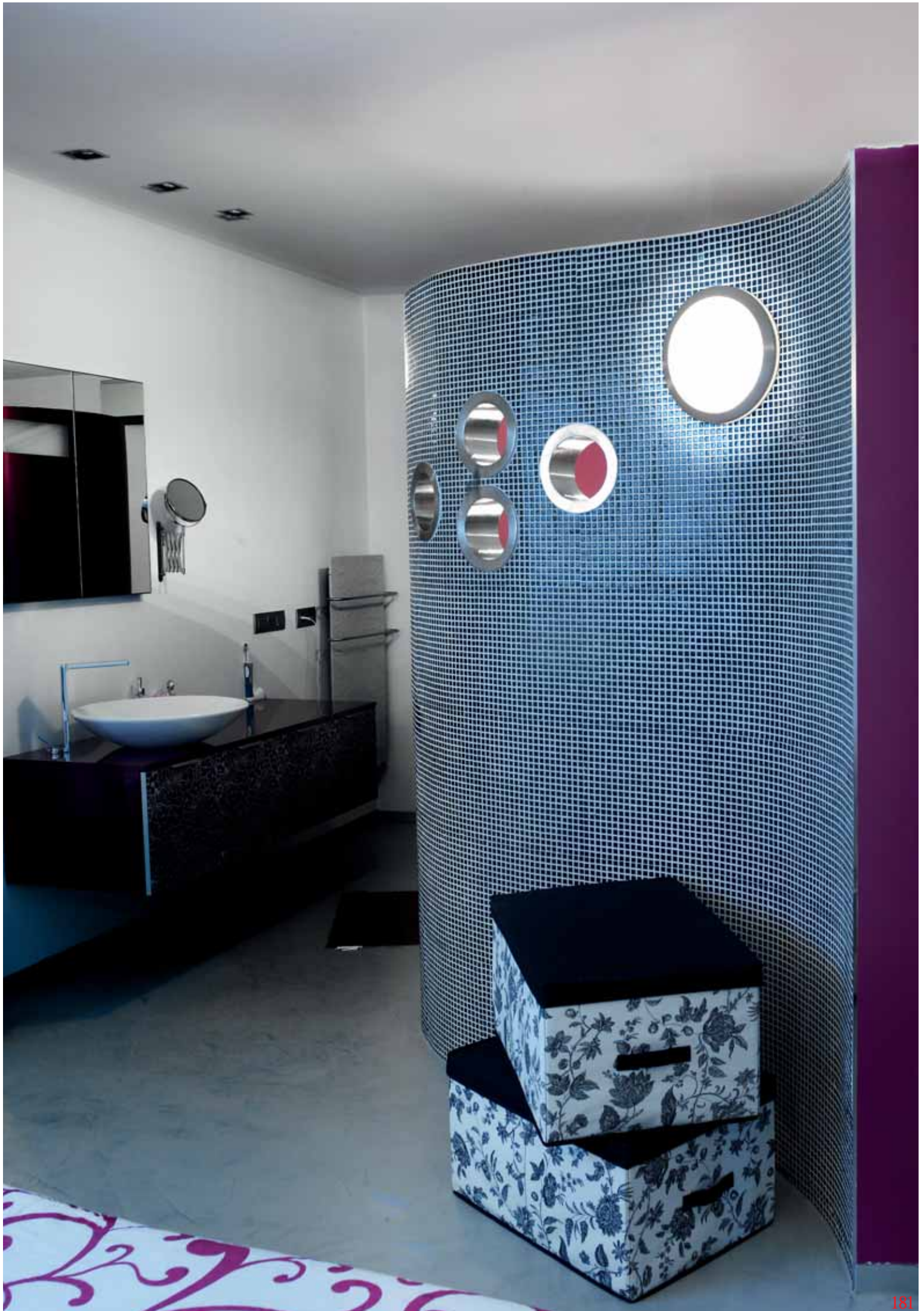

# ska

design \_ Josep Patsí

ska\_collection



Estructura cuadrada metálica en acabado níquel satinado y disponible en 4 tamaños diferentes. Difusor de cristal óptico. Sistema de apertura abatible en todas las versiones (excepto en la de menor tamaño). Luz directa e indirecta.

Square metal body in satin nickel finish and available in 4 different sizes. Optical glass diffuser. Hinged opening system in all versions (except smallest). Direct and indirect light.

Structure carrée métallique avec finitions en nickel satiné. Existe en quatre tailles. Diffuseur en verre optique. Système d'ouverture inclinable pour toutes les versions (sauf celle de taille inférieure). Lumière directe et indirecte.

Quadratisches Gehäuse aus Metall mit Oberfläche in satinierem Nickel. Diffusor aus mattem Optikglas. Kippsystem zum Öffnen bei allen Ausführungen (außer bei der kleinsten Größe). Zur direkten und indirekten Beleuchtung.

Struttura quadrata metallica, con finitura in nichel satinato. Diffusore in cristallo ottico. Sistema di apertura a scomparsa in tutte le versioni (ad eccezione di quella più piccola). Luce diretta e indiretta.

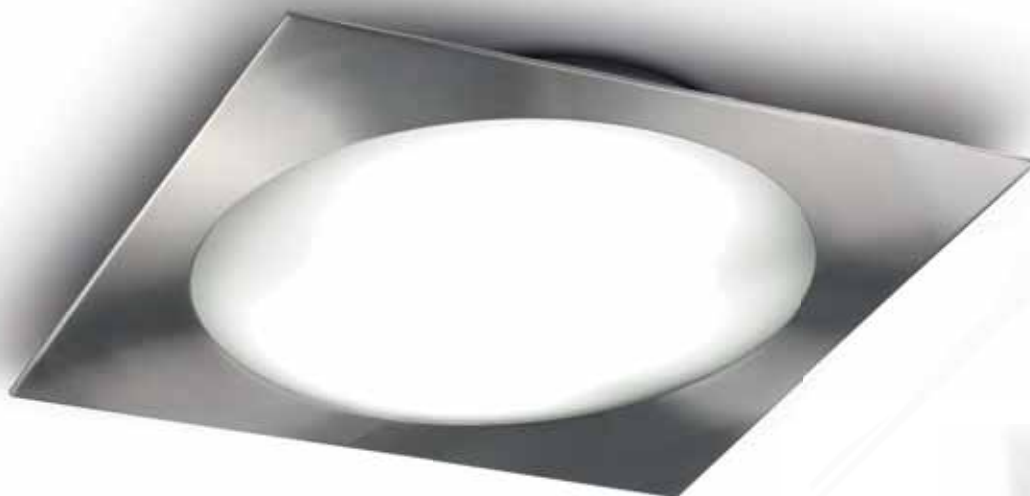

● Níquel Satinado  
Satin nickel  
**81** Nickel satiné  
Nickel matt  
Nichel satinato

○ Cristal óptico  
Optic glass  
**E9** Verre optique  
Optisches Glas  
Vetro ottico

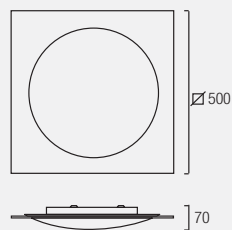

**15-0159-81-E9**

R7s L=118 Max. 300W  
HALOGEN OSRAM included

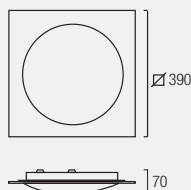

**15-0158-81-E9**

R7s L=118 Max. 200W  
HALOGEN OSRAM included

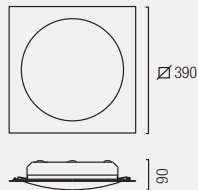

**15-2575-81-E9**

3 x G24d-2 18W  
ENERGY SAVING

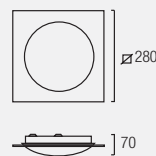

**15-0157-81-E9**

R7s L=118 Max. 150W  
HALOGEN OSRAM included



**15-0318-81-E9**

G9 Max. 75W 230V  
HALOGEN OSRAM included







# quattro

quattro\_collection



Estructura metálica en acabado níquel satinado. Difusor de cristal óptico. Disponible en 3 tamaños diferentes. Luz directa e indirecta.

Satin nickel metal body. Optical glass diffuser. Available in 3 sizes. Direct and indirect light.

Structure métallique avec finitions en nickel satiné. Diffuseur en verre optique. Existe en trois tailles. Lumière directe et indirecte.

Metallgehäuse in satiniertem Nickel. Diffusor aus mattem Optikglas. In 3 Größen lieferbar. Zur direkten und indirekten Beleuchtung.

Struttura metallica con finitura nichel satinato. Diffusore in cristallo ottico. Disponibile in 3 diverse misure. Luce diretta e indiretta.

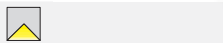

FE GLASS OPT

● Níquel Satinado  
Satin nickel  
**81** Nickel satiné  
Nickel matt  
Nichel satinato

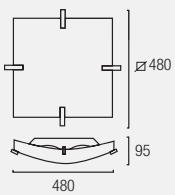

**15-0079-81-B5**  
R7s L=118 Max. 300W  
HALOGEN OSRAM  
included

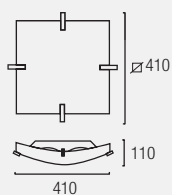

**15-0638-81-B5**  
R7s L=118 Max. 150W  
HALOGEN OSRAM  
included

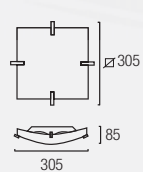

**15-0635-81-B5**  
R7s L=118 Max. 150W  
HALOGEN OSRAM  
included

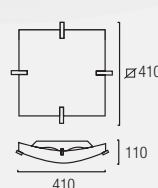

**15-0636-81-B5**  
3 x E-27 ø45 Max. 40W  
INCANDESCENT

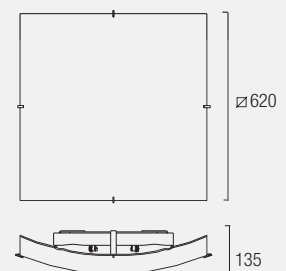

**15-2405-81-B5 (S)**  
R7s L=118 Max. 500W  
HALOGEN OSRAM included





# slimm

design \_ Estudi Ribaudí

slimm\_collection

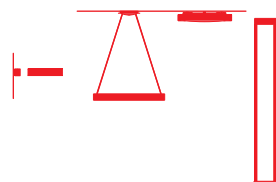

p.72 p.42 p.186 p.210

Estructura metálica disponible en acabados cromo y aluminio mate. Difusor de cristal óptico. Incluye embellecedores de metacrilato en 3 colores intercambiables. Luz directa.

Metal body available in chrome or matte aluminium. Optical glass diffuser. Includes methacrylate trims in 3 interchangeable colours. Direct light.

Structure métallique proposée avec finitions chromées et en aluminium mat. Diffuseur en verre optique. Inclut des caches en méthacrylate en trois couleurs interchangeables. Lumière directe.

Metallgehäuse lieferbar in Chrom und mattem Aluminium. Diffusor aus mattem Optikglas. Mitgeliefert werden austauschbare Plexiglasaufsätze in 3 Farben. Direkte Beleuchtung.

Struttura metallica disponibile con finitura cromata e alluminio opaco. Diffusore in cristallo ottico. Comprende elementi decorativi in metacrilato, in 3 colori intercambiabili. Luce diretta.



● Cromo  
● Chrome  
**21** Chrome  
● Chrom  
● Cromo

● Aluminio mate  
● Matt aluminium  
**Y5** Aluminium mat  
● Alluminium matt  
● Alluminio opaco

○ Cristal óptico  
○ Optic glass  
**E9** Verre optique  
○ Optisches Glas  
○ Vetro ottico

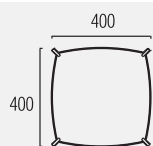

**15-2399-Y5-E9** <sup>(S)</sup>  
**15-2399-21-E9** <sup>(S)</sup>  
R7s L=118 Max. 200W  
HALOGEN OSRAM  
included



Incluye 3 acrílicos de color intercambiables  
Includes 3 color interchangeable acrylic pieces



# adn

design \_ Josep Patsí

adn\_collection

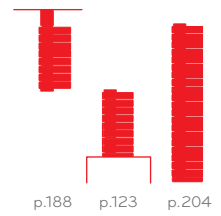

Estructura metálica y embellecedores de ABS ambos en acabado cromo. Difusor compuesto por 8 pantallas giratorias de color blanco escarcha. Luz directa.

Metal body and ABS trims, both finished in chrome. Diffuser consisting of 8 swivel frosted white shades. Direct light.

Structure métallique et caches en ABS avec finitions chromées. Diffuseur composé de huit écrans rotatifs en blanc glacé. Lumière directe.

Metallgehäuse und Zierblende aus ABS, verchromt. Diffusor aus 8 drehbaren in Ice-Weiß. Direkte Beleuchtung.

Struttura metallica ed elementi di finitura in ABS, entrambi con finitura cromata. Diffusore composto da 8 paralumi girevoli in colore bianco ghiaccio. Luce diretta.



- Cromo  
Chrome  
21 Chrome  
Chrom  
Cromo
- Pantallas Blanco Escarcha incluida  
Iced white shades included  
AL Abat-jour gelée blanche compris  
Weiss Schirm inklusiv  
Paralume bianco brina inclusa



**15-2705-21-AL**

T5 24W  
FLUORESCENT included

# CAMALEON



- DN-1302-14-00 QR-111 G53 max. 100W (Ø220 x 170 mm)
- DN-1302-J2-00 QR-111 G53 max. 100W (Ø220 x 170 mm)
- DN-1305-14-00 CDM-R111 GX8.5 max. 70W (Ø220 x 170 mm)
- DN-1305-J2-00 CDM-R111 GX8.5 max. 70W (Ø220 x 170 mm)
- DN-1301-14-00 TC-TEL GX24q-3 2x26/32W (Ø220 x 116 mm)
- DN-1301-J2-00 TC-TEL GX24q-3 2x26/32W (Ø220 x 116 mm)
- DN-1304-14-00 QR-CBC51 GU5.3 max. 50W (Ø120 x 179 mm)
- DN-1304-J2-00 QR-CBC51 GU5.3 max. 50W (Ø120 x 179 mm)
- DN-1303-14-00 QR-CBC51 GU5.3 max. 50W (Ø120 x 150 mm)
- DN-1303-J2-00 QR-CBC51 GU5.3 max. 50W (Ø120 x 150 mm)

**Camaleón es una serie de apliques empotrables multifunción. Ha sido concebida para adaptarse perfectamente a su entorno. Camaleón, en su acabado blanco mate, se ha desarrollado para integrarse cromáticamente en la superficie de instalación. La luminaria permite ser pintada con la misma pintura que usted usaría para colorear su pared o techo camuflándose así de forma perfecta en el ambiente. Una nueva forma de concebir la iluminación.**

*Designed to achieve a perfect integration with the environment, a new range of recessed multifunction fittings is born under the name of Camaleon.*

*The matt white version has been developed to match chromatically with the mounting surface. Its external housing can be coloured with the same paint used on walls or ceilings matching perfectly with different atmospheres.*

*A new lighting concept is born.*



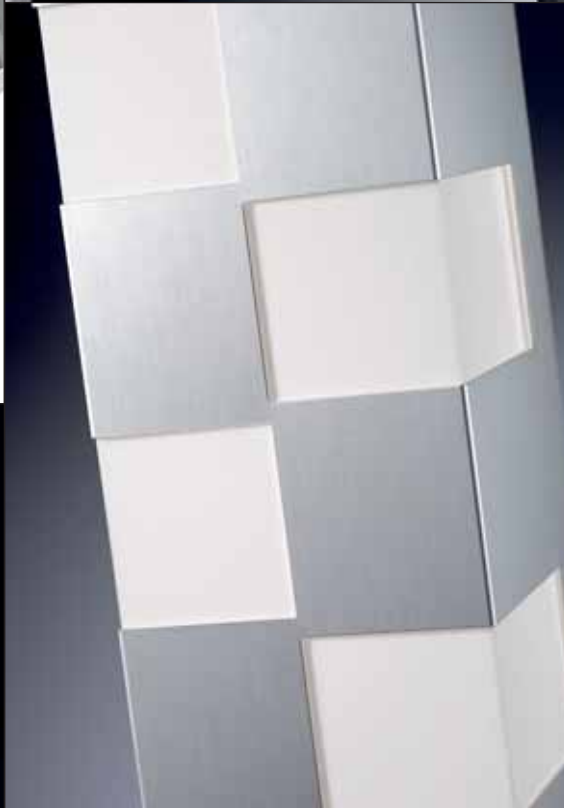





\_pies salón  
\_floor lamps  
\_lampadaires  
\_stehleuchten  
\_lampade da terra

troppo\_192  
escher\_194  
everyday outdoor\_196  
everyday\_200  
umbrella\_202  
adn\_204  
arc\_206  
class\_208  
adagio\_209  
slimm\_210  
leila\_212  
hotels\_214  
soul\_215  
suite\_216  
open\_220  
scala\_222  
fiore\_223  
totem\_224

# tropo

design\_ Benedito Design

tropo\_collection

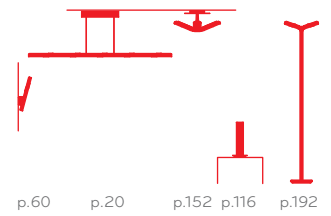

Estructura y brazos de aluminio en acabado cromo. Cristales de borosilicato matizado. Elegante combinación de formas simples: líneas y círculos. Interruptor foot-dimmer incluido. Emite luz directa y también indirecta gracias a la apertura de la parte posterior de los 2 brazos.

Aluminium body and arms finished in chrome. Matte borosilicate glass. Elegant combination of simple shapes-lines and circles. Foot dimmer switch included. Provides direct and indirect light thanks to opening on the back of the 2 arms.

Structure et bras en aluminium avec finitions chromées. Verre borosilicate teinté. Combinaison élégante de formes simples telles que des lignes et des cercles. Pédale interrupteur-variateur fournie. Émet une lumière directe mais aussi indirecte grâce à l'ouverture derrière ses deux bras.

Gehäuse und Arme aus Aluminium, Oberfläche verchromt. Mattes Borosilikatglas. Elegante Kombination einfacher Formen: Linien und Kreise. Inkl. Fußdimmer. Direkte Beleuchtung sowie indirekte Beleuchtung durch die Öffnung an der Rückseite der 2 Arme.

Struttura e bracci in alluminio con finitura cromata. Cristalli di borosilicato opacizzato. Elegante accostamento di forme semplici: linee e cerchi. Compreso interruttore foot-dimmer. Emette luce diretta e indiretta, anche grazie all'apertura nella parte posteriore dei 2 bracci.

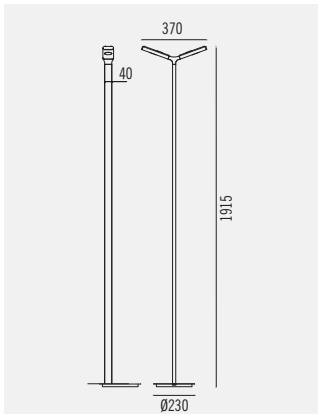

**25-2804-21-F1**

2 x G9 75W

HALOGEN OSRAM included



**FOOT DIMMER**



● Cromo  
● Chrome  
● Chrome  
● Chrom  
● Cromo

○ Cristal anti-deslumbrante  
○ Anti-glare glass  
**F1** Verre antiéblouissante  
Blendfreies Glas  
Vetro antiriflesso

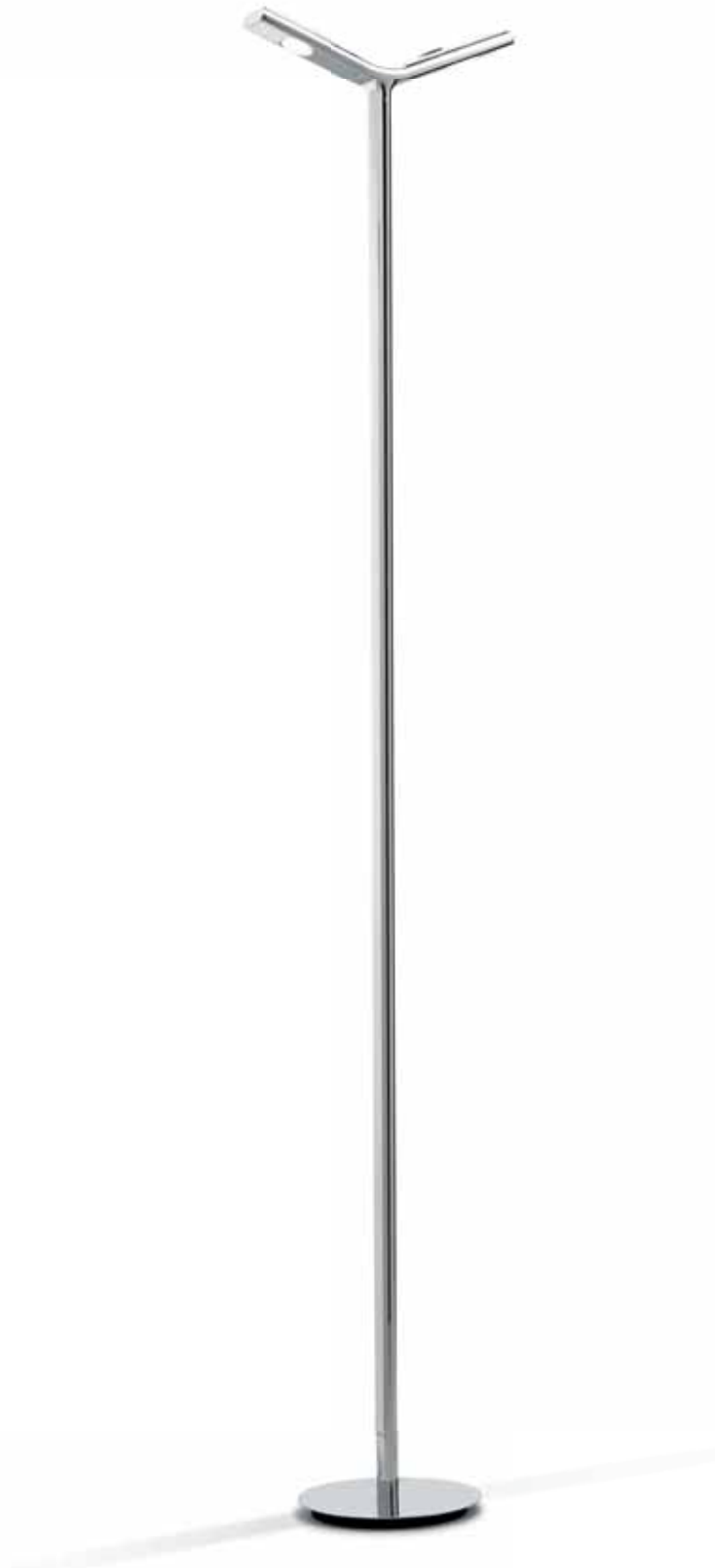



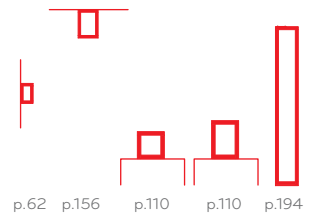

Estructura de aluminio en 3 acabados disponibles: aluminio Ecobright, lacado blanco y lacado negro. Interruptor foot-dimmer incluido. Cable de tela. Luz indirecta.

Aluminium body available in 3 finishes: Ecobright, black lacquer or white lacquer. Foot dimmer switch included. Cord cable. Indirect light.

Structure en aluminium proposée avec trois finitions: aluminium Ecobright, verni blanc et verni noir. Pédale interrupteur-variateur fournie. Câble en tissu. Lumière indirecte.

Gehäuse aus Aluminium in 3 lieferbaren Ausführungen: Ecobright-Aluminium, weiß lackiert und schwarz lackiert. Inkl. Fußdimmer. Textilkabel. Indirekte Beleuchtung.

Struttura in alluminio, disponibile in 3 finiture: alluminio Ecobright, laccato bianco e laccato nero. Compreso interruttore foot-dimmer. Cavo in tela. Luce indiretta.



**25-2782-AH-AH**  
**25-2782-05-05**  
**25-2782-78-78**  
 R7s L=118 Max. 300W  
 HALOGEN OSRAM included

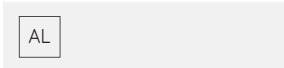

- Aluminio Ecobright  
 Ecobright aluminium  
**AH** Aluminium Ecobright  
 Ecobright aluminium  
 Alluminio Ecobright
- Lacado negro  
 Black lacquered  
**05** Laqué en noir  
 Schwarz lackiert  
 Laccato nero
- Lacado blanco  
 White lacquered  
**78** Laqué en blanc  
 Weiss lackiert  
 Laccato bianco

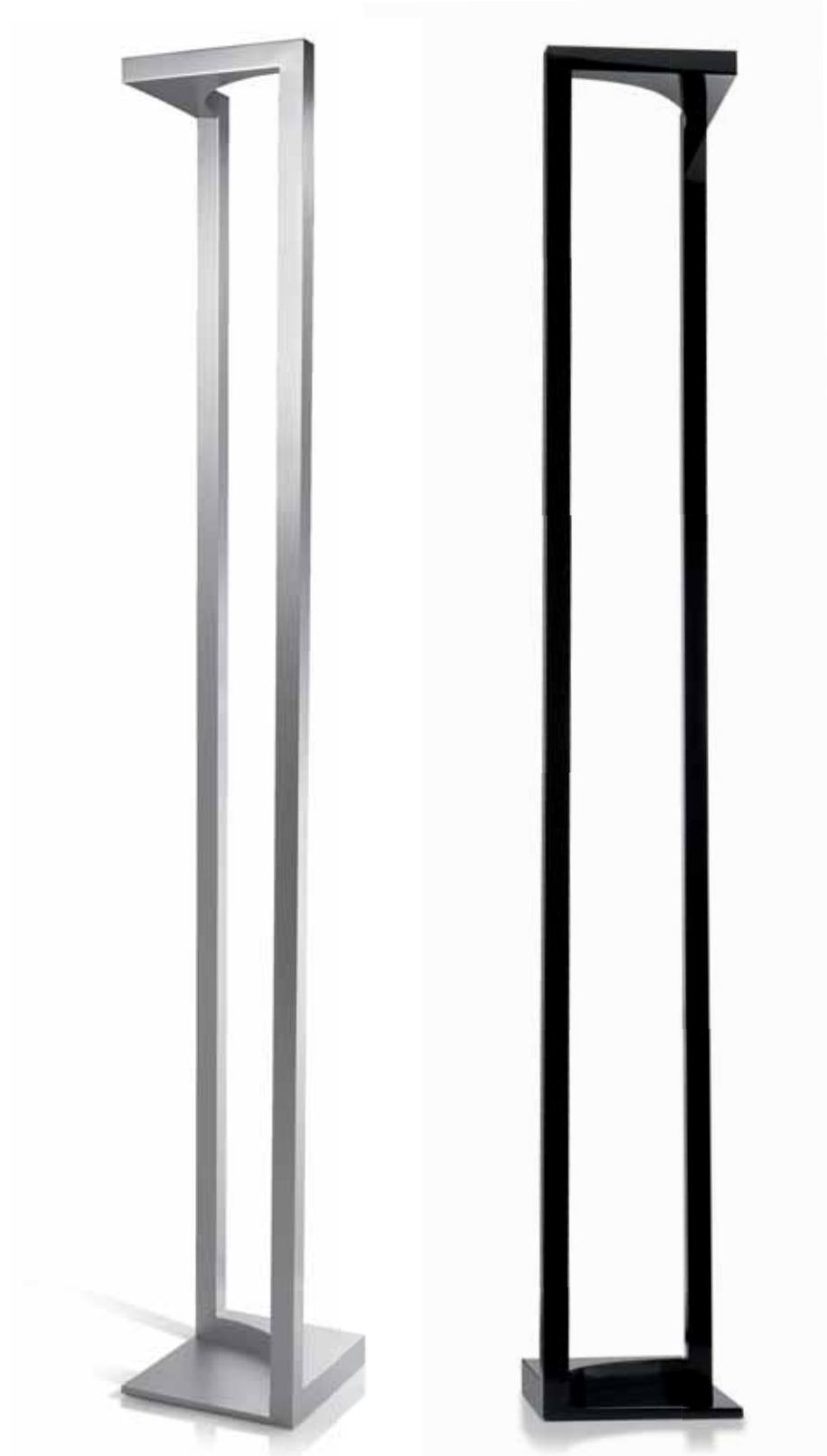



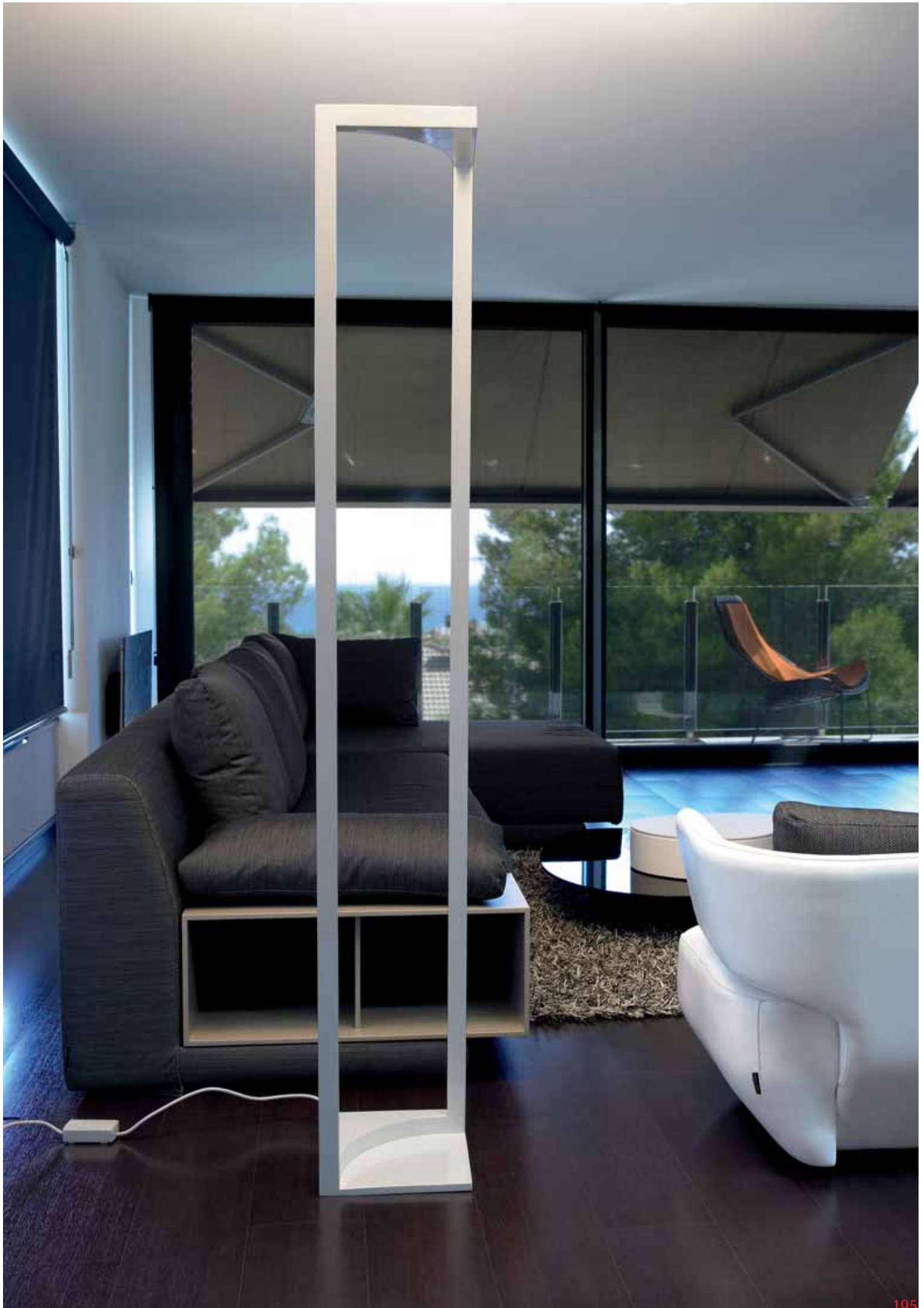



# everyday outdoor

design \_ JBA design

everyday\_collection

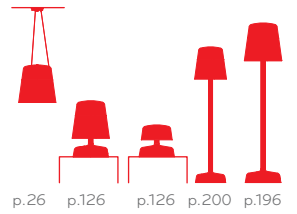

Estructura de aluminio de color blanco. Difusor de polietileno rotomoldeado. Apto para exteriores (IP66). Luz directa.

White aluminium body. Rotomolded polyethylene diffuser. Suitable for exterior (IP66). Direct light.

Structure en aluminium de couleur blanche. Diffuseur en polyéthylène rotomoulé. Convient à un usage en extérieur (IP66). Lumière directe.

Gehäuse aus Aluminium in Weiß. Diffusor aus rotationsgeformtem Polyethylen. Geeignet für Verwendung im Freien (IP66). Direkte Beleuchtung.

Struttura in alluminio di colore bianco. Diffusore in polietilene realizzato con la tecnica Rotomoulded. Adatto per esterni (IP66). Luce diretta.

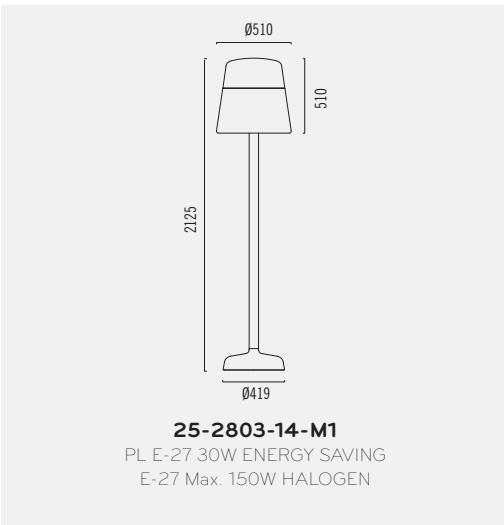

**IP66** ENERGY SAVING



PE AL

○ Blanco White Blanc Weiss Bianco  
**14** ○ Difusor policarbonato opal Opal polycarbonate diffuser Diffuseur polycarbonate opale Polykarbonatdiffusor Opal Diffusore in policarbonato opalino  
**M1**

ELEMENTOS DE FIJACIÓN AL SUELO INCLUIDOS  
 INSTALLATION ELEMENTS INCLUDED

Apta para exteriores / Suitable for outdoor use



everyday outdoor





# everyday

design \_ JBA design

everyday\_collection

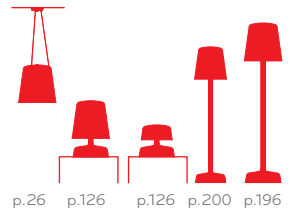

Estructura metálica blanca. Difusor de cristal opal triplex. Interruptor de diseño. Luz directa.

White metal body. Triplex optical glass diffuser. Design switch. Direct light.

Structure métallique blanche. Diffuseur en verre opale triplex. Interrupteur design. Lumière directe.

Metallgehäuse, weiß. Diffusor aus Triplex-Opalglas. Design-Schalter. Direkte Beleuchtung.

Struttura metallica bianca. Diffusore in cristallo opale triplex. Interruttore di design. Luce diretta.

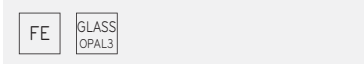
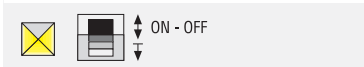
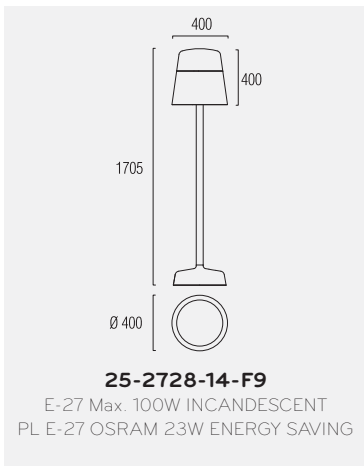





# umbrella

design \_ WIS design

umbrella\_collection

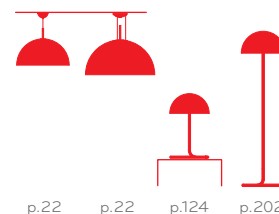

Estructura metálica con pantalla de aluminio semiesférica. Hay 2 versiones disponibles: acabado lacado blanco con pantalla interior plisada plata y acabado lacado negro con pantalla interior plisada dorada. Interruptor de pie incluido. Luz directa.

Metal body with hemisphere aluminium shade. Available in 2 versions: white lacquer finish with inner silver pleated shade and black lacquer finish with inner gold pleated shade. Foot switch included. Direct light.

Structure métallique avec écran semisphérique en aluminium. Existe en deux déclinaisons : une avec finitions en vernis blanc avec écran intérieur plissé couleur argent et une autre avec finitions en vernis noir avec écran intérieur plissé couleur doré. Pédale interrupteur fournie. Lumière directe.

Metallgehäuse mit halbrunden Schirm aus Aluminium. In 2 Ausführungen lieferbar: weiß lackierte Oberfläche mit silberfarben-plissiertem Innenschirm und schwarz lackierte Oberfläche mit goldfarben-plissiertem Innenschirm. Inkl. Fußschalter. Direkte Beleuchtung.

Struttura metallica con paralume semisferico in alluminio. 2 versioni disponibili: finitura laccata bianca con paralume interno plissettato colore argento e finitura laccata nera, con paralume interno plissettato dorato. Interruttore da piede compreso. Luce diretta.

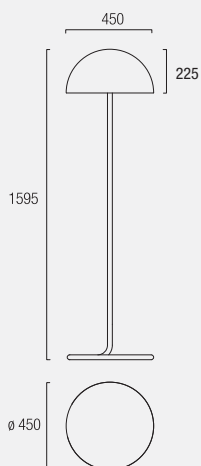

**25-2726-AP-05**  
**25-2726-AQ-78**

3 x PL E-14 OSRAM 11W  
ENERGY SAVING



AL FE PVC TEXTIL

**AP** Pantalla interior plisada dorada  
Golden pleated interior shade  
Intérieur d'abat-jour plissé doré  
Schirm, Innenseite Gold plissée  
Paralume interna plisada oro

**05** Lacado negro  
Black lacquered  
Laqué en noir  
Schwarz lackiert  
Laccato nero

**AQ** Pantalla interior plisada plata  
Silver pleated interior shade  
Intérieur d'abat-jour plissé argenté  
Schirm, Innenseite Silver plissée  
Paralume interna plisada argento

**78** Lacado blanco  
White lacquered  
Laqué en blanc  
Weiss lackiert  
Laccato bianco







# adn

design \_ Josep Patsí

adn\_collection

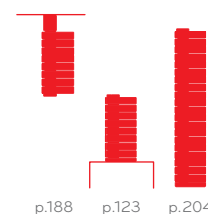

Estructura metálica y embellecedores de ABS, ambos en acabado cromo. Difusor compuesto por 20 pantallas giratorias de color blanco escarcha. Interruptor de pie incluido. Luz directa.

ABS body and trims finished in chrome. Diffuser consisting of 20 swivel frosted white shades. Foot switch included. Direct light.

Structure métallique et caches en ABS, avec finitions chromées. Diffuseur composé de vingt écrans rotatifs en blanc glacé. Pédale interrupteur fournie. Lumière directe.

Metallgehäuse und Zierblende aus ABS, verchromt. Diffusor aus 20 drehbaren in Ice-Weiß. Inkl. Fußschalter. Direkte Beleuchtung.

Struttura metallica ed elementi di finitura in ABS, entrambi con finitura cromata. Diffusore composto da 20 paralumi girevoli in colore bianco ghiaccio. Interruttore da piede compreso. Luce diretta.

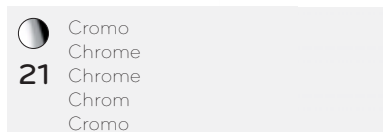
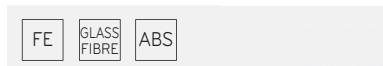
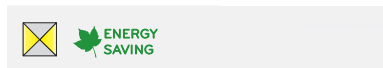
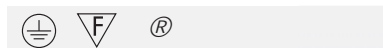
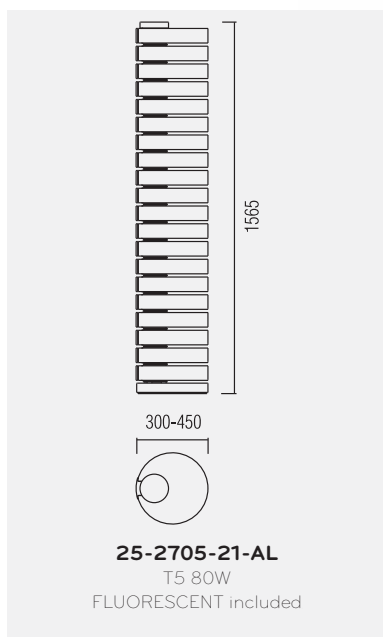





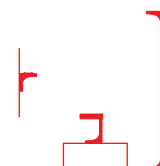

Estructura de aluminio y difusor de metacrilato matizado. Disponible en 3 acabados: aluminio Ecobright, lacado blanco y lacado negro. Interruptor-dimmer incluido. Luz indirecta.

Aluminium body and matte methacrylate diffuser. Available in 3 finishes: Ecobright, black lacquer or white lacquer. Dimmer switch included. Indirect light.

Structure en aluminium et diffuseur en méthacrylate teinté. Proposée avec trois finitions : aluminium Ecobright, verni blanc et verni noir. Interrupteur-variateur fourni. Lumière indirecte.

Gehäuse aus Aluminium und Diffusor aus mattiertem Plexiglas. In 3 Ausführungen lieferbar: Ecobright-Aluminium, weiß lackiert und schwarz lackiert. Inkl. Dimmerschalter. Indirekte Beleuchtung.

Struttura in alluminio e diffusore in metacrilato opacizzato. Disponibile in 3 finiture: alluminio Ecobright, laccato bianco e laccato nero. Interruttore dimmer compreso. Luce indiretta.

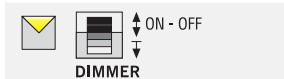
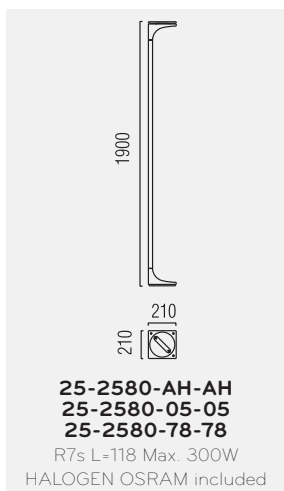

- Aluminio Ecobright  
Ecobright aluminium  
**AH** Aluminium Ecobright  
Ecobright aluminium  
Alluminio Ecobright
- Lacado negro  
Black lacquered  
**05** Laqué en noir  
Schwarz lackiert  
Laccato nero
- Lacado blanco  
White lacquered  
**78** Laqué en blanc  
Weiss lackiert  
Laccato bianco





# class

design \_ Josep Patsí

class\_collection

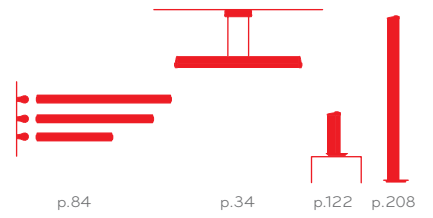

Estructura de aluminio Ecobright. Doble difusor: interior de policarbonato opal y exterior de borosilicato transparente. Interruptor-dimmer incorporado. Luz directa.

Ecobright aluminium body. Double diffuser - inner: opal polycarbonate, exterior: transparent borosilicate Dimmer switch incorporated. Direct light.

Structure en aluminium Ecobright. Double diffuseur : intérieur en polycarbonate opale et extérieur en borosilicate transparent. Interrupteur-variateur incorporé. Lumière directe.

Gehäuse aus Ecobright-Aluminium. Doppelter Diffusor: Innen aus Opal-Polykarbonat und außen aus transparentem Borosilikat. Einschl. eingebauter Dimmerschalter. Direkte Beleuchtung.

Struttura in alluminio Ecobright. Doppio diffusore: interno in policarbonato opale ed esterno in borosilicato trasparente. Interruttore dimmer integrato. Luce diretta.



Doble difusor  
Double diffuser  
Diffuseur double  
Doppelglas  
Difusore doppio

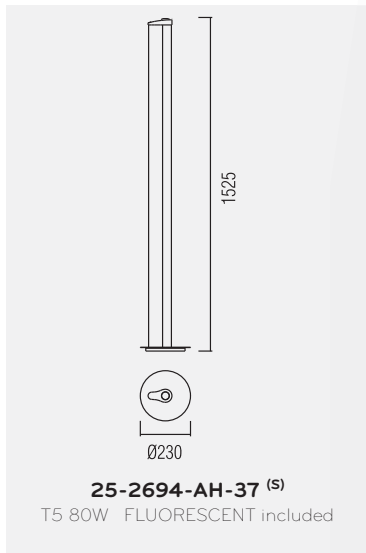

Aluminio Ecobright  
Ecobright aluminium  
**AH** Aluminium Ecobright  
Ecobright aluminium  
Alluminio Ecobright



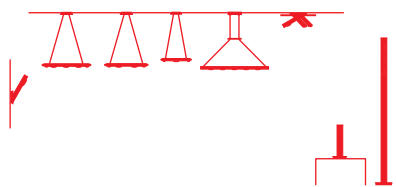

p.68 p.38 p.39 p.38 p.36 p.166 p.118 p.209

Estructura de aluminio y difusores de cristal anti-deslumbrante. Disponible en acabados cromo y aluminio pulido satinado. Interruptor-dimmer incorporado. Emite luz directa y también indirecta gracias a las aperturas de la parte posterior.

Aluminium body and anti-glare glass diffusers. Available in chrome or polished and satin aluminium. Dimmer switch incorporated. Provides direct and indirect light thanks to openings at the back of the luminaire.

Structure en aluminium et diffuseurs en verre anti-reflets. Proposée avec des finitions chromées et en aluminium poli satiné. Interrupteur-variateur incorporé. Émet une lumière directe mais aussi indirecte grâce aux ouvertures postérieures.

Gehäuse aus Aluminium und Diffusore aus entspiegelmtem Glas. Verchromt und in poliertem satiniertem Aluminium lieferbar. Einsch. eingebauter Dimmerschalter. Direkte Beleuchtung sowie indirekte Beleuchtung durch die Öffnungen an der Rückseite.

Struttura in alluminio e diffusori in cristallo anti-abbagliamento. Disponibile con finitura in cromo e alluminio lucido satinato. Interruttore dimmer integrato. Emette luce diretta e indiretta, anche grazie alle aperture nella parte posteriore.

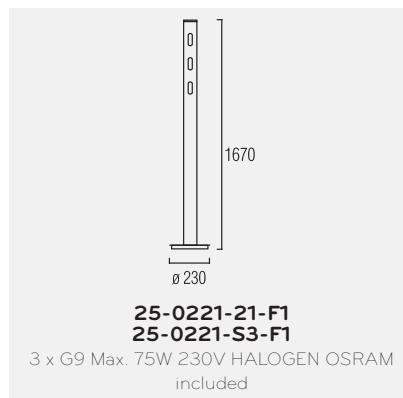
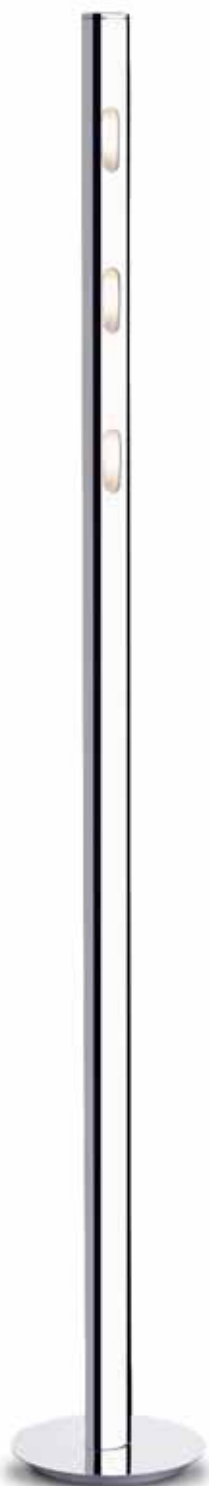

<b>DIMMER</b>		
	Cromo Chrome Chrome Chrom Cromo	
	Aluminio pulido y satinado Polished and burnished aluminium Aluminium poli et satiné Aluminium poliert und mattglänzend Alluminio lucidato e satinato	
	Cristal anti-deslumbrante Anti-glare glass Verre antiéblouissante Blendfreies Glas Vetro antiriflesso	



# slimm

design \_ Estudi Ribaudi

slimm\_collection

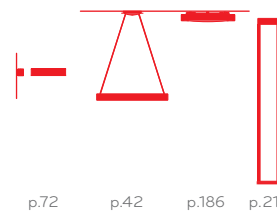

Estructura metálica disponible en acabados cromo y aluminio mate. Difusor de cristal óptico en la parte inferior. Incluye embellecedores de metacrilato en 3 colores intercambiables. Interruptor-dimmer incorporado. Luz directa e indirecta.

Metal body available in chrome or matte aluminium. Optical glass diffuser in lower part. Includes methacrylate trims in 3 interchangeable colours. Dimmer switch incorporated. Direct and indirect light.

Structure métallique proposée avec finitions chromées et en aluminium mat. Diffuseur en verre optique pour la partie inférieure. Inclut des caches en méthacrylate en trois couleurs interchangeables. Interrupteur-variateur incorporé. Lumière directe et indirecte.

Metallgehäuse lieferbar in Chrom und mattem Aluminium. Diffusor aus Optikglas an Unterseite. Mitgeliefert werden austauschbare Plexiglasauflätze in 3 Farben. Einsch. eingebauter Dimmerschalter. Zur direkten und indirekten Beleuchtung.

Struttura metallica disponibile con finitura cromata e alluminio opaco. Diffusore in cristallo ottico nella parte inferiore. Comprende elementi decorativi in metacrilato, in 3 colori intercambiabili. Interruttore dimmer integrato. Luce diretta e indiretta.



**PUSH DIMMER**



Incluye 3 acrílicos de color intercambiables  
Includes 3 color interchangeable acrylic pieces



**PUSH DIMMER**



**21** Cromo  
Chrome  
Chrom  
Cromo

**Y5** Aluminio mate  
Matt aluminium  
Alluminium matt  
Alluminio opaco

**E9** Cristal óptico  
Optic glass  
Verre optique  
Optisches Glas  
Vetro ottico

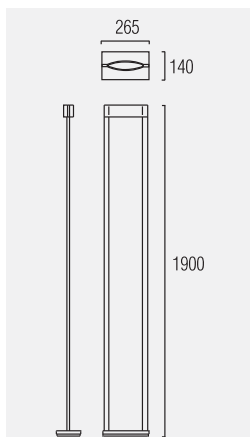

**25-2397-Y5-E9**  
**25-2397-21-E9 (S)**

R7s L=118 Max. 200W  
HALOGEN OSRAM included







# leila

design \_ Benedito Design

leila\_collection

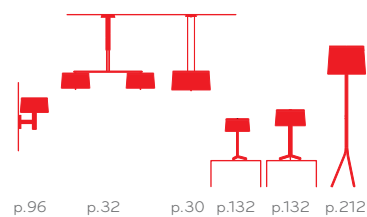

Estructura de aluminio satinado combinado con detalles cromados. Pantalla de tela disponible en negro y en blanco. Sistema de doble iluminación Up & Down. Regulación de la luz superior mediante dimmer y inferior mediante ON-OFF. Luz directa e indirecta.

Satin aluminium body combined with chrome details. Fabric shade available in black and white. Up & Down double lighting system. Upper light regulated using dimmer switch and lower light by using on/off switch. Direct and indirect light.

Structure en aluminium satiné ornée de détails chromés. Écran en tissu proposé en noir et en blanc. Système à double éclairage «Up & Down». Réglage de la lumière supérieure par variateur et de la lumière inférieure par interrupteur. Lumière directe et indirecte.

Gehäuse aus satiniertem Aluminium mit verchromten Details. Stoffschirm lieferbar in Schwarz und Weiß. Doppelles Beleuchtungssystem Up & Down. Regulierung des Oberlichts mit Dimmer und Regulierung des Unterlichts mit On-/Off-Schalter. Zur direkten und indirekten Beleuchtung.

Struttura in alluminio satinato, abbinato a dettagli cromati. Paralume in tela disponibile in colore nero e bianco. Sistema a doppia illuminazione Up & Down. Regolazione della luce superiore tramite un dimmer e di quella inferiore tramite ON-OFF. Luce diretta e indiretta.



PL E-27



DIMMER

G9

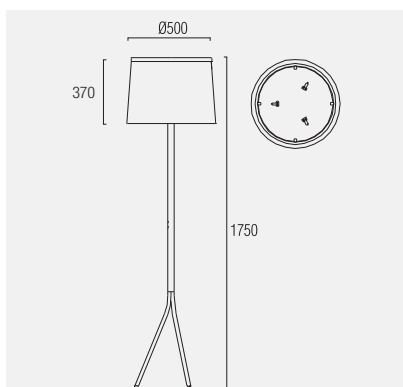

**25-2407-AG-05**  
**25-2407-AG-14**

3 x PL E-27 23W ENERGY SAVING +  
3 x G9 Max. 40W HALOGEN OSRAM included



● Aluminium con cromo  
Aluminium with chrome  
**AG** Aluminium avec chrome  
Aluminium mit Chrom  
Alluminio con cromo

● Pantalla negra de tela incluida  
Black fabric shade included  
**05** Abat-jour noir en tissu compris  
Schwartz Schirm inklusiv  
Paralume di tela nero inclusa

● Pantalla blanca de tela incluida  
White fabric shade included  
**14** Abat-jour blanche en tissu compris  
Weiss Schirm inklusiv  
Paralume di tela bianca inclusa





# hotels

design \_ Benedito Design

hotels\_collection

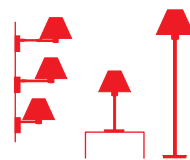

p.98

p.130

p.214

Estructura metálica. Hay 4 posibles combinaciones en función del acabado, níquel satinado pintado u oro pintado; y en función de la pantalla, blanca o beige. Pantallas no incluidas. Interruptor de pie incluido. Luz directa e indirecta.

Metal body. Available in 4 different combinations according to finish (painted satin nickel or painted old) or shade (white or beige). Shades not included. Foot switch included. Direct and indirect light.

Structure métallique. Quatre combinaisons possibles en fonction des finitions (couleur nickel satiné ou peinte dorée) et de l'écran (blanc ou beige). Écrans non fournis. Pédale interrupteur fournie. Lumière directe et indirecte.

Metallgehäuse. 4 mögliche Kombinationen: Oberfläche in lackiertem satiniertem Nickel oder goldfarben lackiert. Lampenschirm weiß oder beige. Schirme nicht im Lieferumfang enthalten. Inkl. Fußschalter. Zur direkten und indirekten Beleuchtung.

Struttura metallica. Possibilità di 4 diverse combinazioni in funzione della finitura, nichel satinato dipinto o oro dipinto e in funzione del paralume, bianco o beige. Paralumi non forniti. Interruttore da piede compreso. Luce diretta e indiretta.

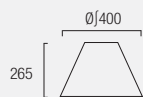

**Pan-104-14**  
**Pan-104-20**

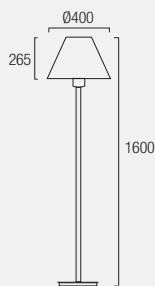

**25-2271-U4-82**  
**25-2271-S8-82**

E-27 Max. 100W  
INCANDESCENT

+  
**Pan-104-14 / Pan-104-20**



● Níquel satinado pintado  
Painted satin nickel  
**U4** Nickel satiné peint  
Lackiertes Nickel matt  
Nichel satinato dipinto

● Oro satinado pintado  
Painted satin gold  
**S8** Or satiné peint  
Lackiertes Gold matt  
Oro satinato dipinto

○ Pantalla blanca  
White shade  
**14** Abat-jour blanc  
Weiss Stoffchirm  
Paralume bianca

○ Pantalla beige  
Beige shade  
**20** Abat-jour beige  
Beige Stoffchirm  
Paralume beige

Para conjunto completo solicite referencias de luminaria y pantalla  
For complete set please order by separate fixture and shade reference

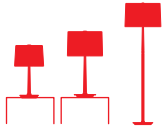

p.131 p.131 p.215

Estructura metálica en acabado cromo. Difusor superior de cristal fumé. Disponible con pantalla de color negro soirée y blanco escarcha. Pantalla de tela incluida. Interruptor foot-dimmer incluido. Luz directa e indirecta.

Chrome metal body. Upper smoked glass diffuser. Available with soirée black or frosted white shades. Fabric shade included. Foot dimmer switch included. Direct and indirect light.

Structure métallique avec finitions chromées. Diffuseur supérieur en verre fumé. Proposée avec écran noir soirée et blanc glacé. Écran en tissu fourni. Pédale interrupteur-variateur fournie. Lumière directe et indirecte.

Gehäuse aus verchromtem Metall. Oberer Diffusor aus Fumé-Glas. Lieferbar mit Schirm in Soirée-Schwarz und Ice-Weiß. Mit Stoffschirm. Inkl. Fußdimmer. Zur direkten und indirekten Beleuchtung.

Struttura metallica con finitura cromata. Diffusore superiore in cristallo fumé. Disponibile con paralume di colore nero soirée e bianco ghiaccio. Fornito paralume in tela. Compreso interruttore foot-dimmer. Luce diretta e indiretta.

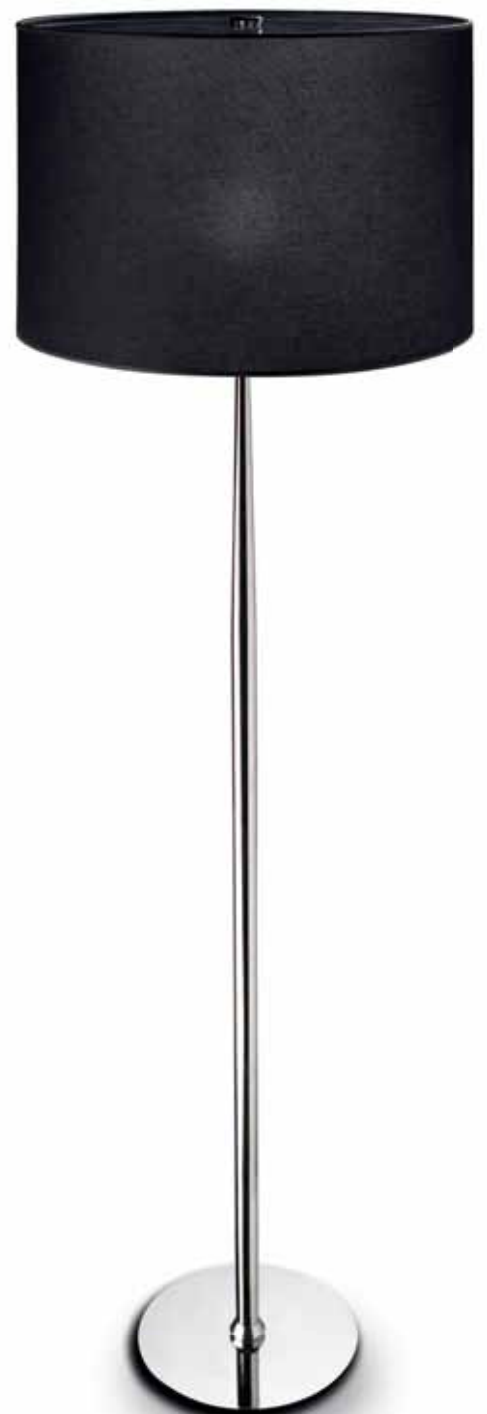

● Cromo  
 Chrome  
**21** Chrome  
 Chrom  
 Cromo

● Pantalla Negro Soirée incluida  
 Black Soiree shade included  
**AK** Abat-jour noir soirée compris  
 Schwartz Schirm inklusiv  
 Paralume nero Soirée inclusa

● Cristal fumé  
 Smoked glass  
 Verre fumé  
 Fumé Glas  
 Vetro fumé

● Pantalla Blanco Escarcha incluida  
 Iced white shade included  
**AL** Abat-jour gelée blanche compris  
 Weiss Schirm inklusiv  
 Paralume bianco brina inclusa

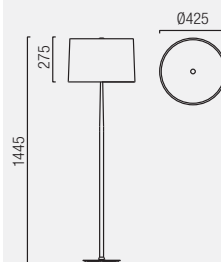

**25-2591-21-AL**  
**25-2591-21-AK**  
 E-27 Max. 100W  
 INCANDESCENT



# suite

design \_ Benedito Design

suite\_collection

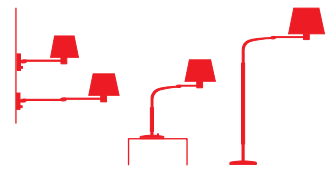

p.94

p.135

p.216

Estructura metálica en acabado níquel satinado. Con pantalla de tela gris Ópera (incluida). Interruptor foot-dimmer incluido. Luz directa.

Satin nickel metal body. Opera grey fabric shade included. Foot dimmer switch included. Direct light.

Structure métallique avec finitions en nickel satiné. Écran en tissu gris Opéra. Pédale interrupteur-variateur fournie. Lumière directe.

Metallgehäuse in satiniertem Nickel. Schirm aus grauem Opera-Stoff (im Preis enthalten). Inkl. Fußdimmer. Direkte Beleuchtung.

Struttura metallica con finitura nichel satinato. Paralume di tela grigia Opera (fornito). Compreso interruttore foot-dimmer. Luce diretta.

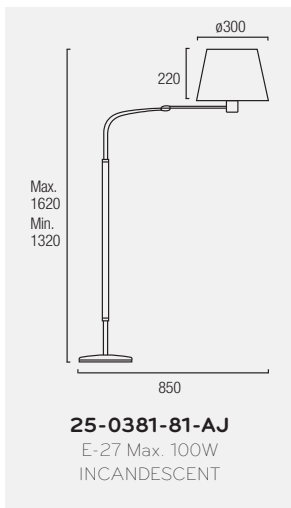

 **FOOT DIMMER**

FE TEXTIL

● Níquel Satinado  
Satin nickel

**81** Nickel satiné  
Nickel matt  
Nichel satinato

● Pantalla Gris Ópera incluida  
Opera Grey shade included  
**AJ** Abat-jour Gris Opéra compris  
Gru Schirm inklusiv  
Paralume grigio inclusa



# suite

design \_ Benedito Design

suite\_collection

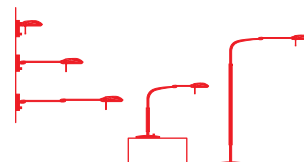

p.92

p.134

p.218

Estructura metálica en acabado níquel satinado. Con difusor de cristal opal satinado. Interruptor foot-dimmer incluido. Luz directa.

Satin nickel metal body. Satin opal glass diffuser. Foot dimmer switch included. Direct light.

Structure métallique avec finitions en nickel satiné. Diffuseur en verre opale satiné. Pédale interrupteur-variateur fournie. Lumière directe.

Metallgehäuse in satiniertem Nickel. Diffusor aus satiniertem Opalglas. Inkl. Fußdimmer. Direkte Beleuchtung.

Struttura metallica con finitura nichel satinato. Diffusore in cristallo opale satinato. Compreso interruttore foot-dimmer. Luce diretta.

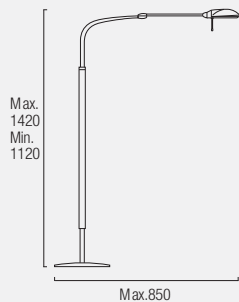
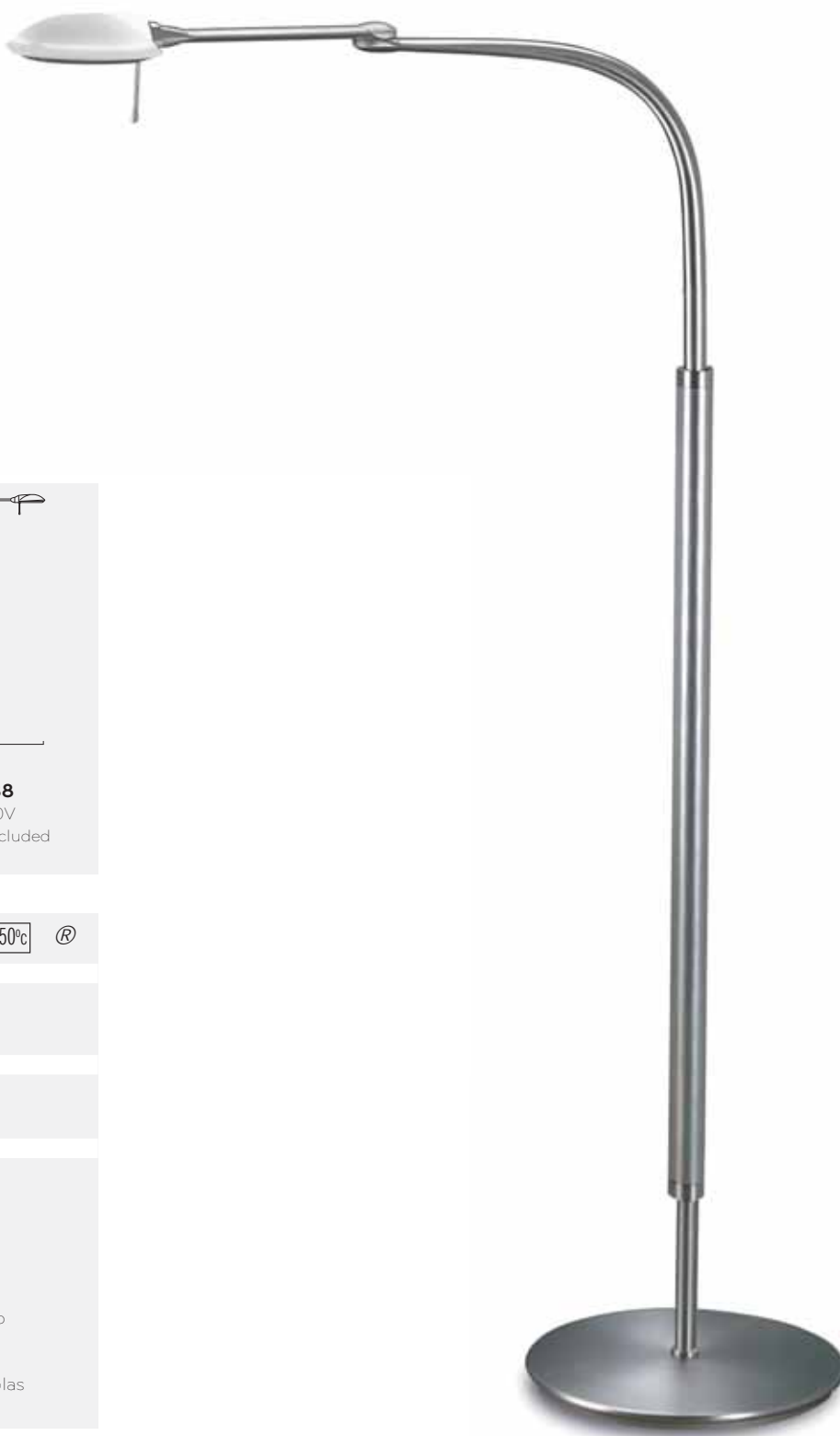

**25-0378-81-B8**

G9 Max. 75W 230V  
HALOGEN OSRAM included



 **FOOT DIMMER**



 Níquel Satinado  
Satin nickel

**81** Nickel satiné  
Nickel matt  
Nichel satinato

 Cristal opal satinado  
Satin opal glass  
**B8** Verre opal satin  
Satiniertes opales Glas  
Vetro opal satinado



# open

design \_ Josep Patsí

open\_collection

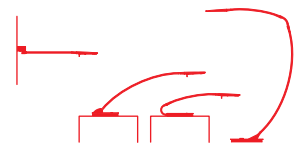

p.90 p.136 p.136 p.220

Estructura de aluminio disponible en acabados Ecobright y cromo. Brazo orientable mediante flexo y cabezal giratorio. Interruptor incorporado. Difusor de policarbonato transparente. Luz directa.

Aluminium body available in Ecobright or chrome finishes. Adjustable arm using flex and swivel head. Incorporated switch. Transparent polycarbonate diffuser Direct light.

Structure en aluminium proposée avec finitions Ecobright et chromées. Bras flexible orientable et tête rotative. Interrupteur incorporé. Diffuseur en polycarbonate transparent. Lumière directe.

Gehäuse aus Aluminium lieferbar in Ecobright und Chrom. Verstellbarer Arm mittels Flexo und Drehkopf. Inkl. Schalter. Diffusor aus transparentem Polykarbonat. Direkte Beleuchtung.

Struttura in alluminio, disponibile con finitura cromata ed Ecobright. Braccio orientabile mediante flexo e testina girevole. Interruttore incorporato. Diffusore in policarbonato trasparente. Luce diretta.



			ENERGY SAVING
	Cromo Chrome Chrome Chrom Cromo		
	Aluminio Ecobright Ecobright aluminium Aluminium Ecobright Ecobright aluminium Alluminio Ecobright		

Min. 470  
Max. 670

Min. 950  
Max. 1550

∅ 250

**25-2708-21-21**  
**25-2708-AH-AH**  
LED OSTAR (OSRAM) 4,5W





# scala

design \_ Josep Patsí / Xavier Muixí

scala\_collection

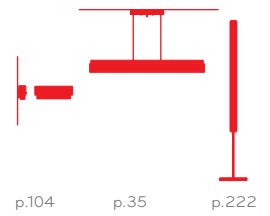

Estructura metálica en acabado cromo. Difusor de cristal fusing con tonos color cava. Interruptor de pie incluido. Luz directa e indirecta.

Chrome metal body. Fusing glass diffuser in pale yellow tones. Foot switch included. Direct and indirect light.

Structure métallique avec finitions chromées. Diffuseur en verre fondu avec des tons champagne. Pédale interrupteur fournie. Lumière directe et indirecte.

Gehäuse aus verchromtem Metall. Diffusor aus Fusing-Glas mit Sektfarbtönen. Inkl. Fußschalter. Zur direkten und indirekten Beleuchtung.

Struttura metallica con finitura cromata. Diffusore in cristallo fusing, con toni color champagne. Interruttore da piede compreso. Luce diretta e indiretta.



<p>● Cromo ● Chrome ● Chrome ● Chrom ● Cromo</p>	<p>● Cristal fusing cava ● Fusing cava glass ● Verre fusing "cava" ● Sektfarbiges-fusing-Glas ● Vetro fusing cava</p>		

**25-2676-21-AO**  
T5 54W FLUORESCENT included

Estructura metálica en acabado aluminio Ecobright. Difusor de cristal opal triplex. 2 interruptores independientes incorporados. Un interruptor enciende, apaga y regula la luz principal; el otro enciende, apaga y cambia el color de la luz ambiente, permitiendo seleccionar entre 7 colores distintos así como el modo de cambio automático de color.

Ecobright aluminium metal body. Triplex optical glass diffuser. 2 independent switches incorporated. One switch turns the main light on/off; the other turns the ambient light on/off and changes the colour, selecting from 7 different colours as well as automatic colour-change mode.

Structure métallique avec finitions Ecobright en aluminium. Diffuseur en verre opale triplex. Deux interrupteurs incorporés indépendants: l'un allume, éteint et régule la lumière principale, l'autre allume, éteint et change la couleur de la lumière d'ambiance (sept couleurs différentes ainsi qu'un mode de changement automatique de la couleur).

Metallgehäuse aus Ecobright-Aluminium. Diffusor aus Triplex-Opalglas. Mit 2 separaten Schaltern geliefert. Ein Schalter schaltet die Hauptlampe ein und aus, der zweite wählt und schaltet die Farbe des Ambientlichts. Auswahl zwischen 7 Farben möglich, sowie Modus zum automatischen Farbwechsel.

Struttura metallica con finitura in alluminio Ecobright. Diffusore in cristallo opale triplex. 2 interruttori indipendenti integrati. Un interruttore accende, spegne e regola la luce principale, mentre l'altro accende, spegne e cambia il colore della luce ambientale, consentendo di scegliere tra 7 diversi colori e la modalità di selezione automatica del colore.

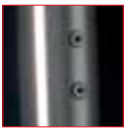

#### LED COLOR CONTROL

Presionar para cambiar el color de los LEDS (7 colores). Incluye opción de cambio automático de color. Presionar durante 2 segundos para apagar los LEDS.

Press to change the color of the LEDS (7 colors). Includes automatic color change. Pressing 2 seconds to switch off the LEDS.

Aluminium Ecobright Ecobright aluminium Aluminium Ecobright Aluminium Ecobright	Cristal opal triplex Triplex Opal glass Verre opal triplex Optishes Glas Vetro ottico		

**25-2687-AH-F9**  
E-14 Max. 150W  
HALOGEN included  
20 LED RGB COLOR SYSTEM



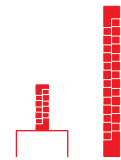

p.140 p.224

Estructura de aluminio en acabado satinado. Difusor acrílico opal. 3 interruptores independientes incorporados. Un interruptor enciende y apaga la luz directa; otro enciende, apaga y regula la luz indirecta superior; y el tercero enciende, apaga y cambia el color de la luz ambiente, permitiendo seleccionar entre 6 colores distintos así como el modo de cambio automático de color.

Satin aluminium body. Opal acrylic diffuser 3 independent switches incorporated. One switch turns the direct light on/off; another turns on/off and regulates the upper indirect light; and the third turns the ambient light on/off and changes the colour, selecting from 6 different colours as well as automatic colour-change mode.

Structure en aluminium avec finitions satinées. Diffuseur acrylique opale. Trois interrupteurs incorporés indépendants: le premier allume et éteint la lumière directe, le deuxième allume, éteint et régule la lumière indirecte supérieure et le troisième allume, éteint et change la couleur de la lumière d'ambiance (six couleurs différentes ainsi qu'un mode de changement automatique de la couleur).

Gehäuse aus Aluminium mit satinierter Oberfläche. Diffusor Opal-Acryl. Mit 3 separaten Schaltern geliefert. Ein Schalter schaltet die direkte Beleuchtung ein und aus, der zweite schaltet und reguliert die indirekte Beleuchtung und der dritte wählt und schaltet die Farbe des Ambientlichts, Auswahl zwischen 6 Farben möglich, sowie Modus zum automatischen Farbwechsel.

Struttura in alluminio, finitura lucida satinata. Diffusore acrilico opale. 3 interruttori indipendenti integrati. Un interruttore accende e spegne la luce diretta, mentre l'altro accende, spegne e regola la luce indiretta superiore. Il terzo, infine, accende, spegne e cambia il colore della luce ambientale, offrendo la possibilità di scegliere tra 6 diversi colori e la modalità di selezione automatica del colore.



Luz superior halógena  
Top halogen light



### TOP HALOGEN LIGHT

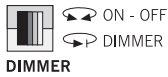

### VERTICAL FLUORESCENT LIGHT



LED COLOR CONTROL  
6-position push button

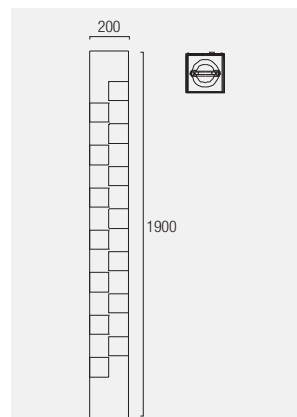
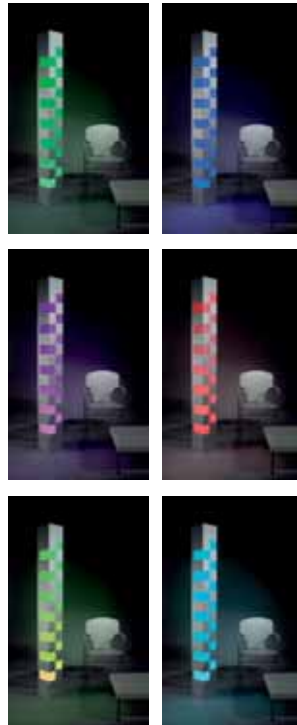

### 25-2384-AF-M1

R7s L=118 Max. 300W  
HALOGEN OSRAM included  
T8 58W  
FLUORESCENT included  
95 LEDS RGB COLOR SYSTEM



AF Aluminio satinado  
Satin aluminium  
Aluminium satiné  
Aluminium matt  
Alluminio satinato

M1 Difusor acrílico opal  
Opal acrylic diffuser  
Diffuseur acrilique opale  
Kunststoff - Reflektor  
Diffusore acrilico opalino

RGB color system with LEDS







[\\_simbologia\\_materiales\\_índice](#)  
[\\_symbols\\_materials\\_index](#)  
[\\_symboles\\_matériaux\\_index](#)  
[\\_symbole\\_materialien\\_index](#)  
[\\_simboli\\_materiali\\_indice](#)

# DIALux

## CONSULTORIA DE ILUMINACIÓN - DIALUX

LEDS-C4 dispone de un departamento técnico de proyectos de iluminación destinado a ayudar y asesorar a nuestros clientes sobre cualquier consulta en materia de iluminación. Este departamento está preparado para seleccionar el tipo de iluminación según sus necesidades y la funcionalidad de la zona. Asimismo, puede asesorarle sobre la mejor distribución de la intensidad de la luz. Además, LEDS-C4 ofrece a sus clientes la posibilidad de trabajar con DIALux, el software líder en planificación de iluminación, que utilizan más de 30.000 proyectistas y lighting designers de todo el mundo.

## LIGHTING CONSULTANCY - DIALUX

LEDS-C4 has a technical department for lighting projects, with the aim to help and advise our clients about any questions they may have about lighting. This department is equipped to select the type of lighting according to your needs and the functionality of the area. It can also advise you on the best distribution of the light intensity.

LEDS-C4 also offers its clients the possibility of working with DIALux, the leading software in lighting planning, with more than 30,000 draftspeople and lighting designers from all over the world.

## LE CONSEIL EN ILLUMINATION - DIALUX

LEDS-C4 dispose d'un département technique de projets d'illumination destiné à aider et conseiller nos clients en matière d'illumination. Ce département est capable de choisir, avec vous, le meilleur type d'éclairage en fonction des vos besoins et des fonctionnalités de la zone en question. Ainsi, nous pouvons vous conseiller sur la meilleure distribution et intensité de la lumière.

De plus, LEDS-C4 offre à ses clients la possibilité de travailler avec DIALux, le logiciel leader en études et simulations d'éclairage, utilisé par plus de 30.000 designers et concepteurs lumière du monde entier.

## CONSULENZA DI ILLUMINAZIONE - DIALUX

LEDS-C4 dispone di un reparto tecnico di progetti di illuminazione destinato ad aiutare e consigliare i nostri clienti per qualsiasi problema in fatto di illuminazione. Questo reparto è preparato per selezionare il tipo di illuminazione a seconda delle necessità del cliente e la funzionalità della zona. Al tempo stesso, il cliente potrà essere consigliato in quanto alla distribuzione ottimale dell'intensità luminosa.

Inoltre, LEDS-C4 offre ai suoi clienti la possibilità di lavorare con DIALux, il software leader in pianificazione di illuminazione, utilizzato da oltre 30.000 progettisti e lighting designer di tutto il mondo.

## ABTEILUNG FÜR BELEUCHTUNGSBERATUNG - DIALUX

LEDS-C4 stellt den Kunden eine Abteilung zur technischen Beratung für Beleuchtungsprojekte zur Verfügung, die bezüglich jeder Angelegenheit im Zusammenhang mit der Beleuchtung Rat und Auskunft erteilt. Diese Abteilung ist Ihnen bei der Auswahl der Beleuchtungsart behilflich, die sich am besten an Ihre Bedürfnisse anpasst und die höchste Funktionalität im jeweiligen Einsatzbereich bietet. Darüber hinaus kann Sie diese Abteilung bezüglich der günstigsten räumlichen Lichtstärkeverteilung beraten.



















LEDS-C4 bietet den Kunden überdies die Möglichkeit, mit DIALux zu arbeiten, der im Bereich der Beleuchtungsplanung marktführenden Software, die von über 30.000 Projekttechnikern und Beleuchtungsdesignern der ganzen Welt benutzt wird.



Marcas y símbolos	Marks and Symbols	Marques et Symboles	Brukezeichen und Symbole	Marche e Simboli
 Todas las luminarias marcadas con este símbolo están construidas de manera que permiten ser instaladas sobre una superficie normalmente inflamable.	All lighting fixtures bearing this symbol are suitable for installation on normally inflammable surfaces.	Tous les appareils marqués avec ce symbole sont fabriqués de façon à permettre leur installation sur une surface normalement inflammable.	Alle mit diesem Symbol gekennzeichneten Leuchten dürfen unter normalen Bedingungen leicht entzündbaren Oberflächen angebracht werden.	Tutte le lampade contraddistinte con questo simbolo sono costruite in modo tale da poter essere installate su di una superficie normalmente infiammabile.
 Todas las luminarias marcadas con este símbolo no pueden ser instaladas sobre una superficie normalmente inflamable.	All lighting fixtures bearing this symbol are unsuitable for installation on normally inflammable surfaces.	Il n'est pas permis d'installer les appareils marqués avec ce symbole sur des surfaces normalement inflammables.	Alle mit diesem Symbol gekennzeichneten Leuchten dürfen nicht auf unter normalen Bedingungen leicht entzündbaren Oberflächen angebracht werden.	Tutte le lampade contraddistinte con questo simbolo non possono essere installate su di una superficie normalmente infiammabile.
 Todas las luminarias marcadas con este símbolo son de Clase I. Estas luminarias disponen sólo de aislamiento básico y, por tanto, deberán conectarse a la toma de tierra de la vivienda.	All light fittings bearing this symbol are Class I models. These light fittings have only basic isolation and therefore must be connected to the earthing system of the residential dwelling.	Toutes les lampes marquées avec ce symbole appartiennent à la Classe I. Ces lampes sont uniquement munies d'une isolation de base et, par conséquent, elles devront être branchées à la prise de terre du logement.	Alle mit diesem Symbol angegebenen Leuchtkörper gehören zur Klasse I. Diese Leuchtkörper haben lediglich eine Einfachisolierung und sind daher an die Erdung der Wohnung anzuschließen.	Tutte le luci contraddistinte con questo simbolo sono di Classe I. Queste luci dispongono solo di isolamento base e, pertanto, devono essere collegate alla presa di terra dell'appartamento.
 Todas las luminarias marcadas con este símbolo son de Clase II. Ninguna parte metálica de las luminarias de Clase II se conectará al conductor de Toma de Tierra de la instalación de la vivienda.	All lighting fixtures bearing this symbol are of Class II. No metal part of Class II fixtures shall be connected to the ground connection of the home installation.	Tous les appareils marqués avec ce symbole appartiennent à la Classe II. Aucune partie métallique d'un appareil de Classe II ne doit être raccordée à la terre.	Alle mit diesem Symbol gekennzeichneten Leuchten gehören der Klasse II an. Metallteile von Klasse II-Leuchten dürfen nicht mit der Erdung der elektrischen Installation in der Wohnung in Berührung kommen.	Tutte le lampade contraddistinte con questo simbolo sono di Classe II. Nessuna parte metallica di queste lampade di Classe II verranno collegate alla Presa di Terra dell'impianto della casa.
 Este símbolo indica la distancia mínima entre el foco de la luminaria y el objeto iluminado.	This symbol indicates the minimum distance to be left between the focus of the lighting fixture and the lighted object.	Ce symbole indique la distance minimale entre la lampe et l'objet à éclairer.	Dieses Symbol gibt den Mindestabstand zwischen der Lichtquelle und dem zu beleuchtenden Objekt an.	Questo simbolo indica la distanza minima tra il fuoco della lampada e l'oggetto illuminato.
 Todas las luminarias marcadas con este símbolo están protegidas contra las proyecciones de agua.	All light fittings bearing this symbol are protected against water projections.	Toutes les lampes marquées avec ce symbole sont protégées contre les projections d'eau.	Alle mit diesem Symbol angegebenen Leuchtkörper sind gegen Spritzwasser geschützt.	Tutte le luci contraddistinte con questo simbolo sono protette contro gli schizzi d'acqua.
 Lámpara totalmente protegida contra la penetración de polvo y contra las pulverizaciones de agua con una presión de 1 bar a 3 metros.	Dust-tight lamp, protected against water jets and against water spray at a pressure of 1 bar at three metres.	Luminaire totalement protégé contre les poussières et les jets d'eau dans toutes les directions et les pulvérisations d'eau à une pression de 1 bar à trois mètres.	Lampe vollkommen geschützt gegen das Eindringen von Staub und gegen Wasserbestäubung mit einem Druck bis zu 1 bar aus 3 Meter Entfernung.	Lampada a prova di polvere e protetta dalle pulverizzazioni d'acqua a pressione di 3 bar a distanza di 3 metri.
 Resistente a hilo incandescente a 850°C.	Resistance to incandescent wire at 850°C.	Tenue au feu 850°C.	Glühdrahtbeständig auf 850°C.	Resistente a filo incandescente 850°C.
 Modelos registrados.	Registered models.	Modèles enregistrés.	Eingetragene Modelle.	Modelli registrati.
 Consultar disponibilidad.	Check availability.	Vérifiez la disponibilité.	Bitte nach Verfügbarkeit fragen.	Verificare la disponibilità.

Simbolos	Symbols	Symboles	Symbole	Simboli	
 <b>OPENING SYSTEM</b>	Sistema de apertura abatible.	Collapsible opening system.	Système d'ouverture rabattable.	Kippbares Öffnungssystem.	Sistema di apertura ribaltabile.
 <b>TILT SYSTEM</b>	Sistema de inclinación.	Tilt system.	Système d'inclinaison.	Neigung system.	Sistema d'inclinazione.
 <b>CABLE IN - OUT</b>	Sistema para recoger el cable.	Cord storage system.	Système pour replier le câble.	System zur Einrollung des Kabels.	Raccogli cavo.
 <b>FUSING</b>	Elaborado artesanalmente mediante la técnica del "fusing".	Manufactured in the traditional way using a "fusing" technique.	Fabrication artisanale à partir de la technique du "fusing".	Handwerklich mittels Fusing-Technik hergestellt.	Realizzato artigianalmente mediante la tecnica del "fusing".
 <b>DIMMER</b>	Con regulador de intensidad.	With dimmer.	Avec régulateur d'intensité.	Mit Intensitätsregler.	Con regolatore d'intensità.
 <b>ON-OFF</b>	Interruptor integrado.	Built-in switch.	Interrupteur intégré.	Eingebauter Schalter.	Interruttore integrato.
 <b>ENERGY SAVING</b>	Bajo consumo.	Energy saving.	Économie d'énergie.	Energiesparlampe.	Risparmio energetico.
 <b>new</b>	Novedad.	New.	Nouveau.	Neu.	Nuevo.
 <b>Elect. inc.</b>	Reactancia electrónica incluida.	Electronic ballast included.	Ballaste électronique compris.	Elektronisches Vorschaltgerät (EVG) inklusiv.	Reattanza elettronica inclusa.
	Dirección del halo de luz.	Halo light direction.	Lichtstrahl Richtung.	Direction flux lumineux.	Direzione del flusso della luce.

	<b>Materiales</b>	<b>Materials</b>	<b>Matériaux</b>	<b>Materialien</b>	<b>Materiali</b>
<b>ABS</b>	ABS	ABS plastic	Plastique ABS	ABS-kunststoff	Plastica ABS
<b>AL</b>	Aluminio	Aluminum	Aluminium	Aluminium	Alluminio
<b>FE</b>	Acero	Steel	Acier	Stahl	Acciaio
<b>GLASS BOSI</b>	Vidrio de borosilicato	Borosilicate glass	Verre borosilicaté	Borosilikatglas	Vetro borosilicato
<b>GLASS FUME</b>	Vidrio fumé	Smoked glass	Verre fumé	Fumé glas	Vetro fumé
<b>GLASS FUSING</b>	Cristal fusing	Fusing glass	Verre fusing	Fusing-Glas	Vetro fusing
<b>GLASS MAT</b>	Vidrio mate	Matt glass	Verre mat	Matter Glas	Vicchiere matt
<b>GLASS OPAL3</b>	Cristal opal tríplex	Triplex Opal glass	Verre opal triplex	Optishes Glas	Vetro ottico
<b>GLASS OPT</b>	Cristal óptico	Optic glass	Verre optique	Optishes Glas	Vetro ottico
<b>GLASS TRANS</b>	Cristal transparente	Transparent glass	Verre transparent	Transparenter Glas	Vicchiere transparente
<b>PC</b>	Policarbonato	Polycarbonate	Polycarbonate	Polykarbonat	Polycarbonate
<b>PE</b>	Polietileno	Polyethylene	Polyéthylène	Polyethylen	Polietilene
<b>PMMA</b>	PMMA	PMMA	PMMA	PMMA	PMMA
<b>POL +FV</b>	Poliéster + fibra vidrio	Polyester + fiberglass	Polyester + fibre de verre	Polyester + glasfaser	Poliestere + fibra di vetro
<b>PUR</b>	Poliuretano	Polyurethane	Polyuréthane	Polyurethan	Poliuretano
<b>PVC</b>	PVC	PVC	PVC	PVC	PVC
<b>TEXTIL</b>	Tela	Fabric	Tissu	Stoff	Tela
<b>ZAMAK</b>	Zamak	Zamak	Zamak	Zamak	Zama

	<b>Especificación Bombillas</b>	<b>Bulbs Specification</b>	<b>Spécification Ampoules</b>	<b>Beschreibung Leuchtmittel</b>	<b>Caratteristiche Lampadina</b>
INCANDESCENT	 E-27 Standard	 E-27 ø45	 E-14	 E-14	
HALOGEN	 R7s Halogen	 Halopin G9 Osram	 E-14	 E-27 Standard	
ENERGY SAVING FLUORESCENT	 PL elec E-27	 G24d1  G24d1	 2G11	 G13 / T8	 G5 T5 / TL5  2GX13 / T5 circular
LED	 LED	 RGB LED	 GU 10 LED		



# \_índice\_index\_indice

<b>colgantes</b> <b>pendants</b> <b>suspensions</b> <b>pendelleuchten</b> <b>lampade a sospensione</b>	05-2577.....102 05-2578.....102 05-2580.....66 05-2673.....76 05-2676.....104 05-2694.....84 05-2695.....84 05-2696.....84 05-2708.....90 05-2782.....62 05-2804.....60 05-2870.....56	15-2385.....171 15-2386.....171 15-2387.....171 15-2388.....170 15-2389.....170 15-2390.....168 15-2391.....168 15-2393.....168 15-2399.....186 15-2405.....184 15-2575.....182 15-2705.....188 15-2779.....158 15-2780.....158 15-2781.....158 15-2782.....156 15-2804.....152 15-2805.....164 15-2806.....164 15-2807.....162 15-2870.....150 15-4314.....146 15-4316.....146 15-4318.....144 15-4332.....148 IBIS C/17.....174 IBIS C/27.....174 IBIS C/37.....174 IBIS C/47.....174
00-0087.....50 00-0221.....36 00-0254.....52 00-0338.....48 00-0573.....44 00-2397.....42 00-2407.....30 00-2673.....40 00-2676.....35 00-2694.....34 00-2725.....28 00-2726.....22 00-2727.....22 00-2728.....26 00-2801.....16 00-2804.....20 00-2872.....18 00-4348.....12 20-0221.....38 20-0313.....38 20-0325.....46 20-0326.....46 20-0536.....39 20-2407.....32	<b>sobremesas</b> <b>table lamps</b> <b>lampes de tables</b> <b>tischleuchten</b> <b>lampade da tavolo</b>	
<b>apliques</b> <b>wall fixtures</b> <b>appliques</b> <b>wandleuchten</b> <b>lampade da parete</b>	10-0080.....138 10-0221.....118 10-0378.....134 10-0381.....135 10-2056.....120 10-2271.....130 10-2278.....128 10-2384.....140 10-2407.....132 10-2571.....132 10-2580.....114 10-2591.....131 10-2592.....131 10-2694.....122 10-2705.....123 10-2708.....136 10-2709.....136 10-2726.....124 10-2728.....126 10-2729.....126 10-2782.....110 10-2804.....116 10-2809.....110	<b>pies salon</b> <b>floor lamps</b> <b>lampadaires</b> <b>stehleuchten</b> <b>lampade da terra</b>
05-0196.....100 05-0221.....68 05-0265.....86 05-0266.....86 05-0267.....86 05-0325.....82 05-0378.....92 05-0379.....92 05-0380.....92 05-0381.....94 05-0382.....94 05-0567.....71 05-0570.....74 05-0571.....74 05-0572.....74 05-0573.....70 05-1876.....103 05-2271.....98 05-2272.....98 05-2273.....98 05-2274.....98 05-2275.....98 05-2276.....98 05-2366.....74 05-2367.....74 05-2397.....72 05-2407.....96 05-2572.....78 05-2573.....78 05-2574.....80	<b>plafones</b> <b>ceiling fixtures</b> <b>plafoniers</b> <b>deckenleuchten</b> <b>plafoniere</b>	25-0221.....209 25-0378.....218 25-0381.....216 25-2271.....214 25-2384.....224 25-2397.....210 25-2407.....212 25-2580.....206 25-2591.....215 25-2676.....222 25-2687.....223 25-2694.....208 25-2705.....204 25-2708.....220 25-2726.....202 25-2728.....200 25-2782.....194 25-2803.....196 25-2804.....192
	15-0079.....184 15-0157.....182 15-0158.....182 15-0159.....182 15-0221.....166 15-0222.....180 15-0223.....178 15-0256.....180 15-0258.....178 15-0318.....182 15-0562.....176 15-0590.....172 15-0591.....172 15-0592.....172 15-0635.....184 15-0636.....184 15-0638.....184 15-2138.....177	<b>pantallas</b> <b>shades</b> <b>abat-jours</b> <b>schirme</b> <b>paralumi</b>
		PAN-100.....128 PAN-103.....98, 130 PAN-104.....214

**Información general**  
**General information**  
**Information générale**  
**Allgemeine Informationen**  
**Informazione generale**

• Las descripciones y medidas de los aparatos del presente catálogo son orientativas, pudiendo por tanto ser modificadas, a fin de mejorar las características técnicas o de diseño. • La empresa se reserva el derecho de anular o modificar cualquier modelo sin previo aviso. • Todos los modelos presentados cumplen las normas exigidas por la C.E. para aparatos de iluminación de uso doméstico y sus características vienen determinadas por las clases I y II. • Los acabados y las especificaciones técnicas corresponden a los productos que se suministran en Europa, pudiendo éstos variar en otros mercados. • Para una buena conservación de las lámparas, no usar bombillas de potencia superior a las recomendadas y limpiar simplemente con un paño seco. No usar limpia metales, ya que dañan los barnices protectores que garantizan la duración del acabado.

• The descriptions and dimensions of the items in this catalogue are indicative and may be modified for the purpose of technical or design improvements. • We reserve the right to cancel or change all models without prior notice • All items meet the E.C. Class I and Class II safety regulations for home lighting appliances. • The finishes and technical specifications listed here are for the European market and may vary elsewhere. • Do not use stronger bulbs than recommended, and always clean lamps with a soft dry cloth alone since metal polish will damage the protective finish.

• Les descriptions et mesures des appareils de ce catalogue sont données à titre d'orientation, pouvant être modifiées dans le but d'améliorer les caractéristiques techniques ou de design. • L'usine se réserve le droit d'annuler ou modifier l'un ou l'autre de ses modèles sans avis préalable. • Tous les modèles présentés sont conformes aux normes exigées par la C.E. pour les appareils d'éclairage domestique et leur caractéristiques sont déterminées par le classe I et II. • Les finitions et spécifications techniques correspondent à la demande du marché européen. Elles peuvent être modifiées pour d'autres pays. • Ne pas utiliser d'ampoules d'une puissance supérieure à celle recommandée. Pour un bon entretien, utiliser simplement un chiffon sec. N'utilisez aucun produit pour métaux, ils abiment le vernis protecteur.

• Die Beschreibung und Maße der in diesem Katalog aufgeführten Modelle dienen der Orientierung und können zur Verbesserung der technischen Eigenschaften oder des Designs geändert werden. • Der Hersteller behält sich das Recht vor, Modelle zu ändern oder aus dem Programm zu nehmen. • Die gezeigten Modelle erfüllen alle die innerhalb der EU geforderten Normen und Richtlinien für Leuchten für allgemeine Beleuchtungszwecke der Schutzklassen I und II. • Die Ausführungen und technischen Daten gelten für den europäischen Markt und können in anderen Ländern abweichen. • Für eine gute Erhaltung der Leuchten ist der Betrieb mit Lampen höherer Leistung als empfohlen zu vermeiden. Zur Reinigung benutzen Sie einfach ein trockenes Tuch, da Metallputzmittel die Schutzlackierung angreifen.

• Le descrizioni e le dimensioni degli articoli del presente catalogo vengono fornite a mero titolo orientativo e possono pertanto essere modificate al fine di migliorarne le caratteristiche tecniche o di design. • La Casa si riserva il diritto di cessare la produzione o di modificare qualsiasi modello senza preavviso. • Tutti i modelli presentati sono conformi alle normative C.E. per gli articoli da illuminazione per uso domestico di classe I e II. • Le rifiniture e le specifiche tecniche corrispondono ai prodotti venduti in Europa; tali dati possono pertanto variare su altri mercati. • Per una buona conservazione delle lampade, non utilizzare lampadine di potenza superiore a quella consigliata e pulirle semplicemente con un panno asciutto. Non utilizzare prodotti per la pulizia del metallo che potrebbero rovinare le vernici di protezione che garantiscono la vita della rifinitura.

• Todos los derechos reservados. Ninguna parte de este libro puede ser reproducida en ningún formato de papel o electrónico, sin el consentimiento previo del editor o de los propietarios de los derechos.

• All rights reserved. No part of this publication may be reproduced or transmitted in any form or by any means, electronic storage and retrieval system, without permission in writing from the copyright owner (s).

• Tous droits réservés. Aucune partie de ce livre ne pourra être reproduite en format papier ou électronique sans l'autorisation préalable de l'éditeur ou du propriétaire des droits.

• Sämtliche Rechte vorbehalten. Kein Teil dieses Buches darf in keinem Papier- oder elektronischem Format ohne ausdrückliche Zustimmung des Herausgebers oder der Inhaber der Urheberrechte wiedergegeben oder vervielfältigt werden.

• Tutti i diritti riservati. Nessuna parte di questo libro può essere riprodotta in nessun formato cartaceo o elettronico, senza la previa autorizzazione dell' editore o dei proprietari dei diritti.



**LEDS-C4, S.A.**

Afuera s/n, - 25750 - TORA (Lleida) SPAIN

[www.leds-c4.com](http://www.leds-c4.com)

**España**

Tel.: 973 46 81 01

Fax.: 973 46 81 29

[info@leds-c4.com](mailto:info@leds-c4.com)

**Europe**

Tel.: + 34 973 46 81 02

Fax.: + 34 973 46 81 06

[europe@leds-c4.com](mailto:europe@leds-c4.com)

**France - Portugal**

Tel.: + 34 973 46 81 30

Fax.: + 34 973 46 81 29

[france@leds-c4.com](mailto:france@leds-c4.com)

[portugal@leds-c4.com](mailto:portugal@leds-c4.com)

**Asia - Pacific and Africa**

Tel.: + 34 973 46 81 16

Fax.: + 34 973 46 81 06

[export@leds-c4.com](mailto:export@leds-c4.com)

**USA - Canada - Ireland**

Tel.: +34 973 46 81 09

Fax: +34 973 46 81 06

[lighting@leds-c4.com](mailto:lighting@leds-c4.com)

**América Latina**

Tel.: + 34 973 46 81 15

Fax.: + 34 973 46 81 06

[sudamerica@leds-c4.com](mailto:sudamerica@leds-c4.com)

**Middle East Countries**

Tel.: + 34 973 46 81 08

Fax.: + 34 973 46 81 06

[dep-export@leds-c4.com](mailto:dep-export@leds-c4.com)