

faro

**THE
COL
LEC
TION**

INDOOR & OUTDOOR LIGHTING

BELIEVE
IN
SIMPLE
BUT
INGENIOUS
IDEAS



Reference: A0205

Design and layout: FARO GROUP

Photo: FOTODISSENY/GUILLEM F-H

Printing: LITOSTAMP S. A

We believe in simple but ingenious ideas. Like how to create functional design lamps accessible to everyone.

We are passionate about our business. Because it is the result of years of learning and exciting experience. 62 to be precise. A long journey that has helped us to learn and improve. To give substance to our offer.

Creemos en las ideas sencillas pero ingeniosas. Como la de crear lámparas de diseño y funcionales accesibles a todo el mundo.

Nos apasiona lo NUESTRO. Porque es el resultado de apasionantes años de aprendizaje y de experiencia. 62 en concreto. Un largo recorrido que nos ha servido para aprender y perfeccionar. Para dar consistencia a nuestra propuesta.

Nous misons sur des idées simples mais ingénieuses. Comme celle de créer des lampes de design fonctionnel accessible à tous.

Nous sommes passionnés par notre métier. Parce que c'est le résultat d'années passionnantes d'apprentissage. 62 pour être plus précis. Un long voyage qui nous a aidé à apprendre et à nous améliorer.



Manel
Llusçà



Pepe
Llaudet

Estudi
Ribaudí



We enjoy working with prestigious designers who create models with a unique and unmistakable style. Our designs are easy to understand, accessible and functional.

Our in-house design team is constantly on a quest for new materials, processes and technologies.

Contamos con la colaboración de prestigiosos diseñadores con los que trabajamos en modelos con un estilo propio e inconfundible. Nuestros diseños son fáciles de entender, cercanos y funcionales. Nuestro equipo interno de diseño está en constante búsqueda de nuevos materiales, procesos y tecnologías.

Nous coopérons avec de prestigieux designers afin d'élaborer des modèles avec un style propre et inimitable. Nos designs sont faciles à comprendre, familiers et fonctionnels. Notre équipe interne de design recherche en permanence de nouveaux matériaux, de nouveaux processus et de nouvelles technologies.

ALPHABETICAL INDEX
Índice alfabético
Index alphabétique

A

ÁNCORA 148

B

BIRD 80

BLUBS 112

BOLETUS 128

C

CERES 156

CODE 136

CONO 74

CROSS 124

D

DATNA 88

DRAGMA 152

E

ETERFAN 10

F

FARETTO 14

FLEXI 42

FOKUS 54

FUTURE 140

H

HOTEL 18

K

KLAMP 100

L

LINDA 30

LINK 34

M

MISTU 120

MIX 26

MOON 108

MUFFIN 116

N

NEWPORT 104

NEXO 50

NUK 172

P

PÉRGAMO 70

PROA 144

PROJECT 164

R

RATTAN 160

S

SAC 62

SENTINEL 96

STEPS 84

SWEET 22

T

TREE 38

TRIAL 132

TWIN 66

V

VERSUS indoor 46

VERSUS outdoor 168

W

WINCH 58

Y

YAK 92

INDEX

INDEX BY SECTIONS

Índice por secciones

Index par sections

FANS

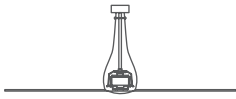

ETERFAN
10



FARETTO
14

TECHNICAL



FOKUS
54

PENDANT LAMPS



HOTEL
18

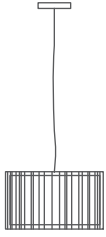

LINDA
30



LINK
34



MIX
26

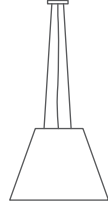

PÉRGAMO
70

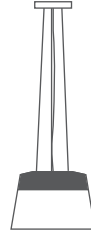

SAC
62

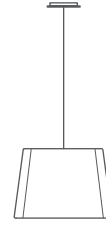

SWEET
22



TREE
38



WINCH
58

WALL LAMPS



CONO
74

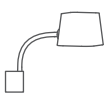

FLEXI
42



HOTEL
18



LINDA
30



LINK
34



MIX
26



SAC
62



SWEET
22



TWIN
66



WINCH
58

TABLE LAMPS



FLEXI
42



HOTEL
18



LINDA
30



LINK
34



MIX
26



SAC
62



SWEET
22



TREE
38



VERSUS
46

FLOOR LAMPS



FLEXI
42



HOTEL
18

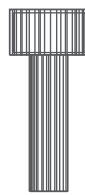

LINDA
30



LINK
34



MIX
26



NEXO
50



SAC
62



SWEET
22



TREE
38

ETERFAN



Faro
Team





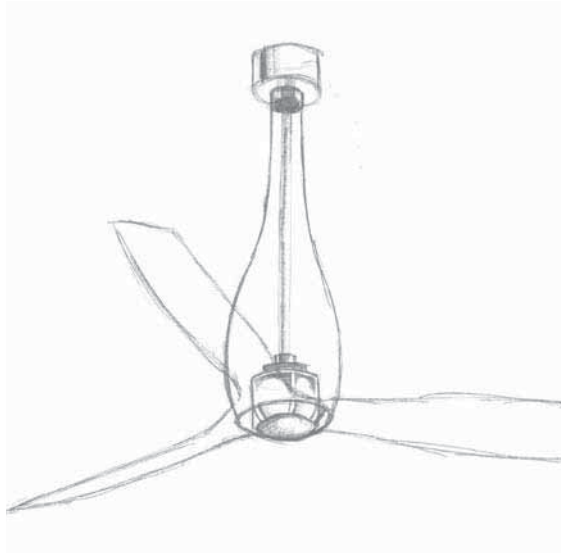

ETERFAN is a breakthrough in ceiling fan design. It combines the best of traditional processes with the latest trends in fan.

ETERFAN

Faro
Team

ETERFAN es una revolución en el diseño de los ventiladores de techo. Combina lo mejor de los procesos artesanales con las últimas tendencias en ventilación.

L'ETERFAN est un ventilateur de plafond au design révolutionnaire. Il associe le meilleur des processus artisanaux aux dernières tendances en matière de ventilation.



i pag 184



FARETTO



Faro
Team





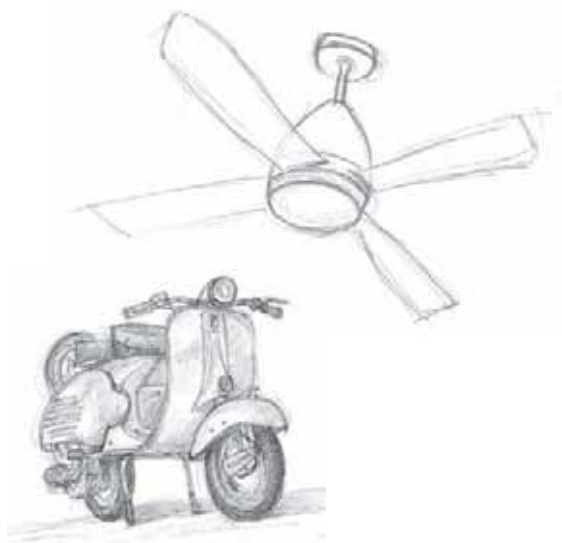

The legendary 1946 Italian Vespa motorcycle has become a real source of inspiration. More than a fan, it is a way of life.

FARETTO

Faro
Team

La histórica motocicleta italiana Vespa 1946 se ha convertido en una auténtica fuente de inspiración. Más que un ventilador es una forma de vida.

La légendaire Vespa de 1946 est devenue une réelle source d'inspiration. Plus qu'un ventilateur, c'est un style de vie.

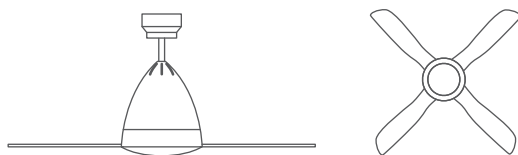

i pag 185



HOTEL



Manel
Lluscà





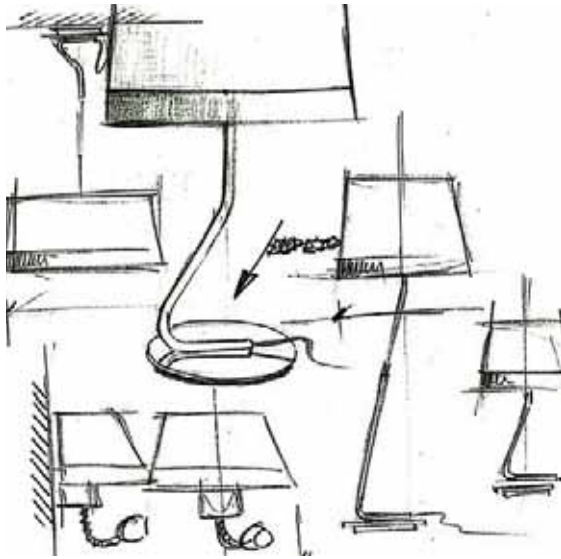

The HOTEL serie aims to achieve a simple and somewhat neutral line, giving prominence to the warmth and comfort it offers. For a relaxing and pleasant environment.

HOTEL

Manel
Lluscà

La serie HOTEL pretende seguir una línea sobria y un tanto neutra dando protagonismo a la calidez y practicidad que aporta. Para conseguir un ambiente sosegado, nítido y agradable.

Le design de la série HOTEL tend vers la sobriété et la neutralité afin de mettre en valeur la chaleur et le confort qu'elle apporte. Pour une ambiance détendue, claire et agréable.

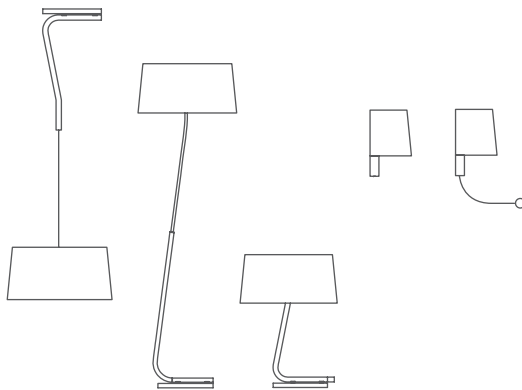

① pag 187



SWEET



Estudi
Ribaudí







SWEET is characterised by its rounded shapes and the harmony of its changes in texture that interact with us in a perfect balance.

SWEET

Estudi
Ribaudí

SWEET se caracteriza por sus formas redondeadas y la armonía de sus cambios de textura que interactúan con nosotros en perfecto equilibrio.

SWEET est caractérisée par ses formes arrondies et par l'harmonie de ses changements de matière qui interagissent avec nous dans un équilibre parfait.

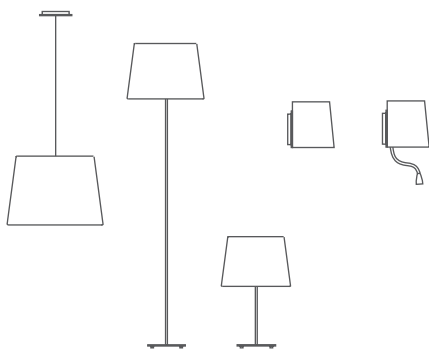

① pag 199





MIX



Manel
Lluscà





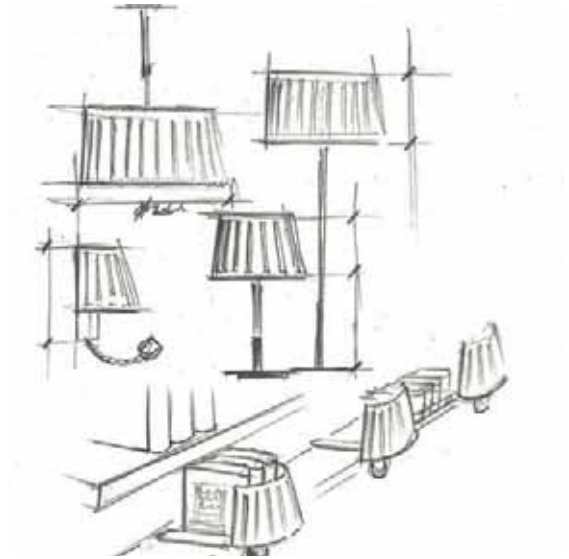

A mixture of materials for a series that provides the warmth of light by creating a comfortable environment. Discrete slits allow light to shine out, generating a chiaroscuro effect.

MIX

Manel
Lluscà

Mixtura de materials para una serie que consigue ofrecer la calidez de la luz generando un ambiente confortable. Discretas rendijas dejan escapar la luz generando un juego de claroscuros.

Un mélange de matériaux pour une série qui parvient à transmettre la chaleur de la lumière et à créer un environnement confortable. Des fentes discrètes laissent passer la lumière et créent un jeu de clair-obscur.





LINDA



Estudi
Ribaudí





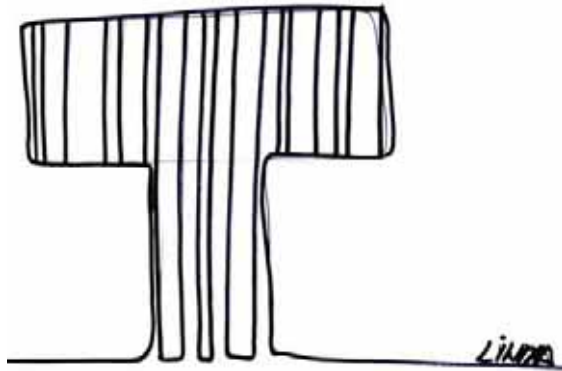

LINDA projects light through its structure, creating a pattern of light and shadow that confers movement and energy to our spaces.

LINDA

Estudi
Ribaudí

LINDA proyecta la luz a través de su estructura, generando una trama de luces y sombras que ofrecen movimiento y dinamismo a nuestros espacios.

LINDA projette la lumière à travers sa structure, créant ainsi toute une trame d'ombres et de lumières qui apportent mouvement et dynamisme à nos espaces.

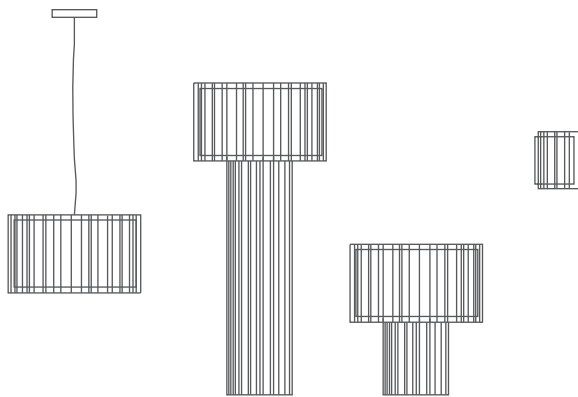



LINK



Estudi
Ribaudí





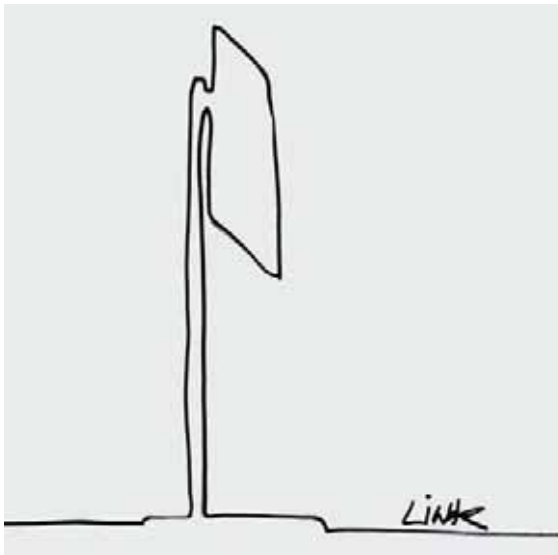

LINK is the synthesis of a spot as an object. It is a search for the absence of shape, a simple gesture to give sense to its aesthetic.

LINK

Estudi
Ribaudí

LINK es la síntesis del foco como objeto; es la búsqueda de la ausencia de la forma, un simple gesto para encontrar una estética que le da sentido.

LINK est la synthèse du spot en tant qu'objet ; c'est la recherche de l'absence de forme, une esthétique simple qui lui donne tout son sens.



Orientable

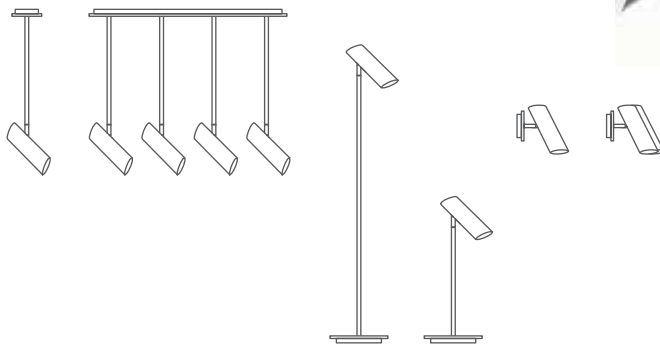



TREE



Estudi
Ribaudí





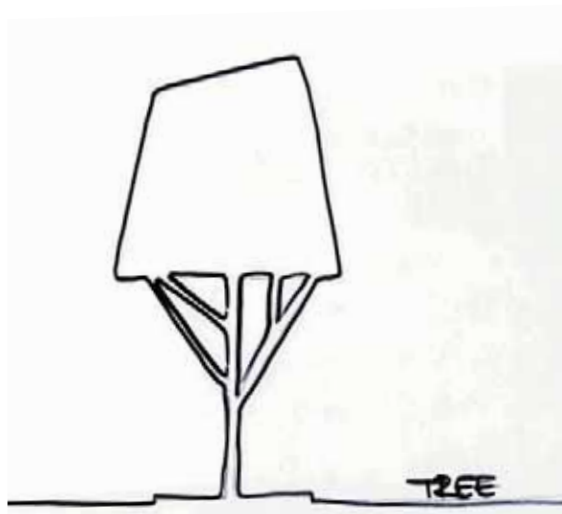

TREE stems from the interaction of human beings with their environment. Its branches grow towards the top, which is where the light emerges from.

TREE

Estudi
Ribaudí

TREE nace de la interacción del ser humano con su entorno. Sus ramas crecen hacia el interior de la copa, y es allí donde surge la luz.

TREE est le fruit de l'interaction de l'homme avec son environnement. Ses branches poussent vers la cime, d'où jaillit la lumière.

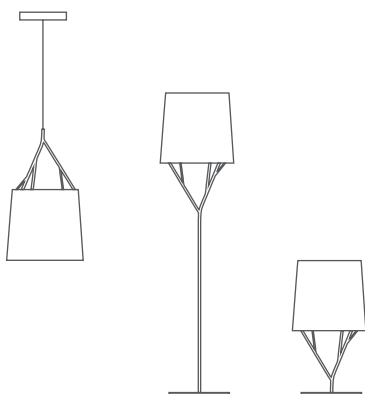



FLEXI



Manel
Lluscà





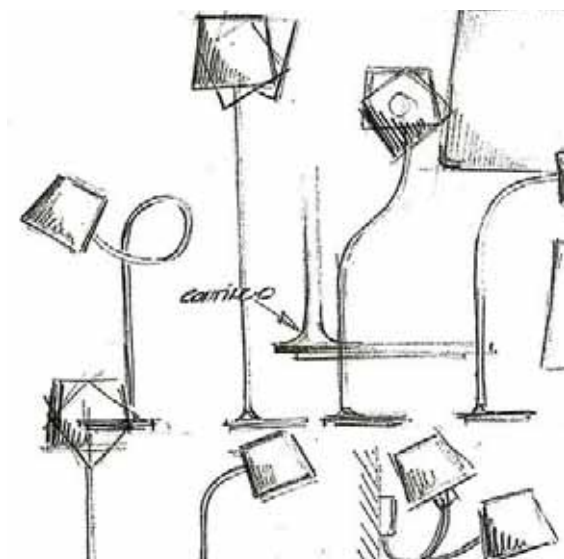

A casual, very versatile luminaire line with infinite positions and great practical applications. It can be used constantly to create new shapes and redecorate the living space.

FLEXI

Manel
Lluscà

Una línea de luminaria desenfadada, muy versátil, de infinitas posiciones y de gran practicidad. Con la que constantemente podemos crear nuevas formas y para redecorar el habitáculo.

Une ligne de luminaires apaisants, polyvalents, orientables à l'infini et extrêmement pratiques qui nous permettent de créer de nouvelles formes et de redécorer l'espace intérieur à notre guise.

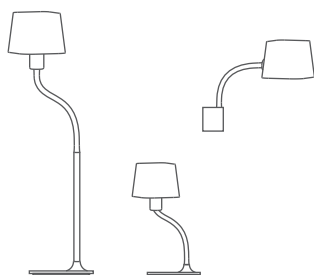

① pag 185





VERSUS



Pepe
Llaudet





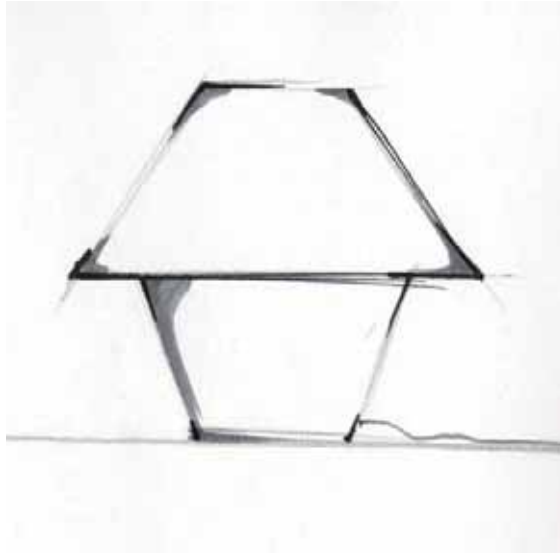

Simple, easily-integrated and versatile. A contemporary object with a classic geometrical design formed from two conical elements of the same type and material, to form a single, unique lighting element.

VERSUS

Pepe
Llaudet

Simple, integrable y versátil. Objeto contemporáneo y de geometría clásica que se forma a partir de dos elementos cónicos del mismo material y naturaleza unidos formando un solo elemento lumínico singular.

Simple, facile à intégrer et polyvalent. Objet contemporain à la géométrie classique composé de deux éléments coniques de la même matière et de la même nature unis pour ne former qu'un seul et même luminaire original.

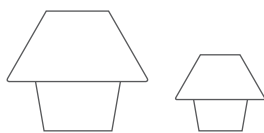

i pag 202



NEXO



Estudi
Ribaudí







NEXO is an ambient light which incorporates a spotlight. Light flows through a single element that directs it in a gentle and balanced composition.

NEXO

Estudi
Ribaudí

NEXO es una luz de ambiente que incorpora una luz puntual; estas fluyen por un único elemento que las ordena en una suave y equilibrada composición.

NEXO est un luminaire d'ambiance équipé d'un éclairage ponctuel. Un seul objet qui associe deux lumières en une composition douce et équilibrée.

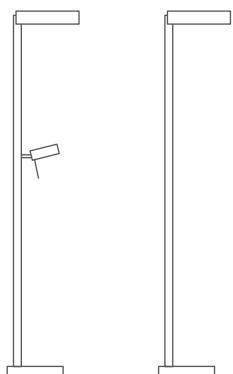

i pag 195





FOKUS



Faro
Team with EINA



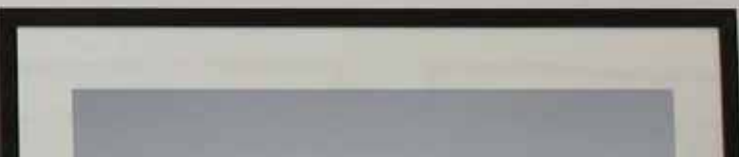

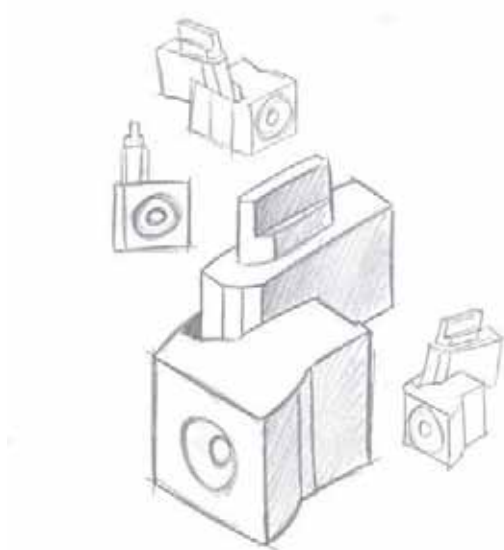

FOKUS was born from FARO GROUP'S commitment to a design school. FARO GROUP collaborates with EINA giving students a chance to produce their own designs. The FOKUS family is designed to work with multiple light sources (QR-CB51, QR-111, CDM-Tm, HIT-T, CDM-R111, QR-111 LED).

FOKUS

Faro
Team with EINA

FOKUS nace del deseo de FARO GROUP de brindar a un estudiante de EINA la oportunidad de ver en el mercado su propia creación. La familia FOKUS está diseñada para poder alojar múltiples fuentes lumínicas (QR-CB51, QR-111, CDM-Tm, HIT-T, CDM-R111, QR-111 LED).

FOKUS est né du désir de FARO GROUP d'offrir à un étudiant en Design, l'opportunité de mettre sur le marché sa création. La gamme FOKUS a été conçue pour pouvoir s'adapter à de nombreuses sources lumineuses (QR-CB51, QR-111, CDM-Tm, HIT-T, CDM-R111, QR-111 LED).



More info on www.faropro.es

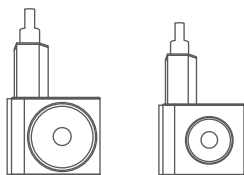



WINCH



Manel
Lluscà





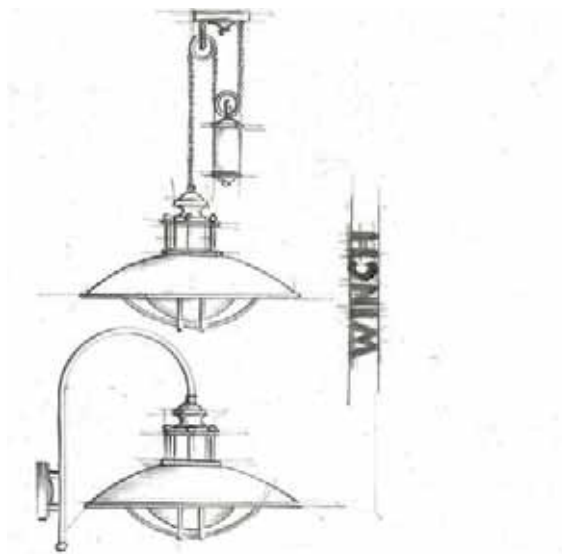

Inspired by the gas lamps of the old fishing boats from the Mediterranean coast, it gives memories and calmness to all its surroundings. WINCH is peacefulness and rest in its purest form.

WINCH

Manel
Llusçà

Inspirada en las luces de gas de las antiguas barcas de pesca del litoral Mediterráneo, dota de nostalgia y calma a todo lo que la rodea. WINCH es quietud y melancolía en su estado más puro.

Inspiré par les lampes à gaz des bateaux de pêche dantan qui naviguaient le long des côtes méditerranéennes, elle procure calme et nostalgie à son environnement. WINCH, cest le calme et la mélancolie dans son expression la plus simple.

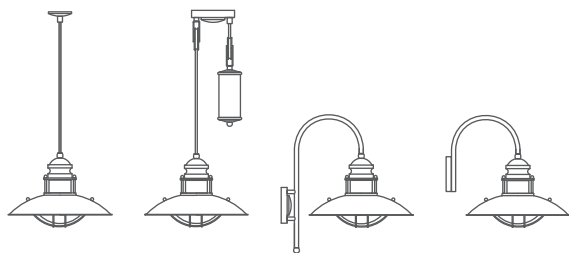



SAC



Manel
Lluscà





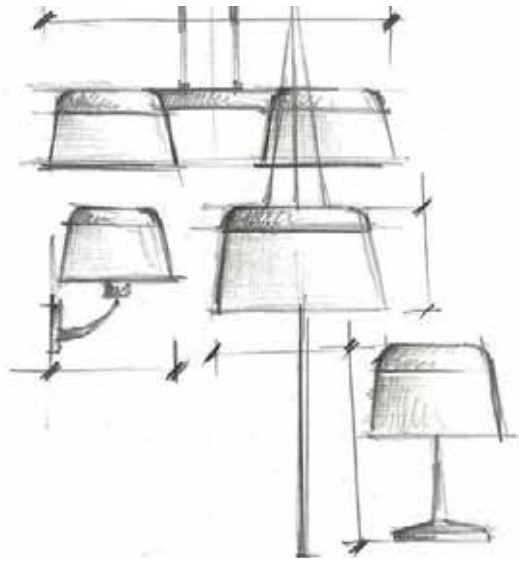

The SAC family exudes a rustic feeling with a contemporary design combining a textured metal structure and a fabric shade that provides a soft, warm light.

SAC

Manel
Lluscà

La familia SAC destila un aire rústico con un diseño contemporáneo combinando una estructura en metal texturizado y una pantalla de tela que proporciona una luz cálida y suave.

La ligne SAC dégage quelque chose de rustique malgré son design contemporain alliant une structure en métal texturé et un abat-jour en tissu qui offre une lumière douce et chaude.

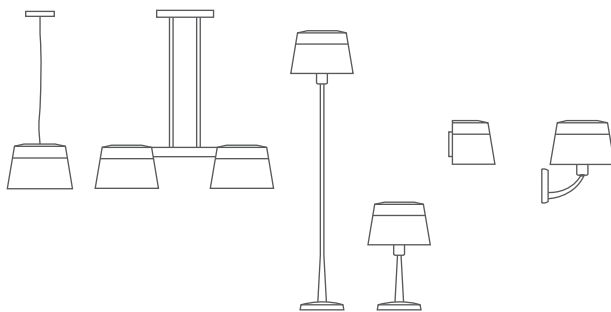



TWIN



Manel
Lluscà





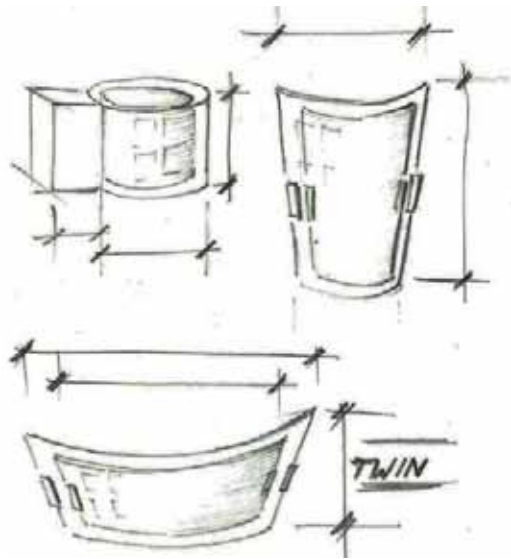

Rugged and rough inside, but pure and transparent outside. A splitted personality for a model of pure, clean lines, playing with transparency.

TWIN

Manel
Lluscà

Rugoso y áspero en su interior, pero puro y transparente en su parte más visible. Un modelo de líneas puras y limpias, que juega con la transparencia.

Un intérieur robuste et rugueux, mais un extérieur pur et transparent des plus visibles. Un modèle aux lignes épurées, jouant avec la transparence.

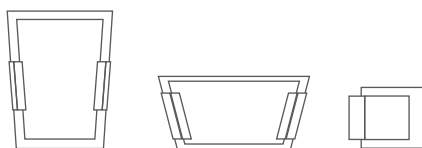



PÉRGAMO



Faro
Team







Contrast between materials and colours. A piece that is as delicate as the materials from which it is made of and which invites you to decipher the message hidden inside.

PÉRGAMO

Faro
Team

Contraste entre materiales y colores. Una pieza tan delicada como el material del que está hecha y que invita a descifrar el mensaje que esconde en su interior.

Le contraste entre les matériaux et les couleurs. Une pièce qui est aussi délicate que le matériel dans lequel elle est fabriquée et qui vous invite à déchiffrer le message qui se cache en son sein.

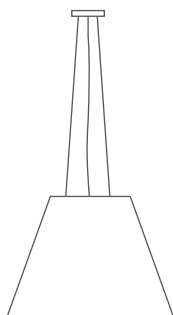



CONO



Faro
Team





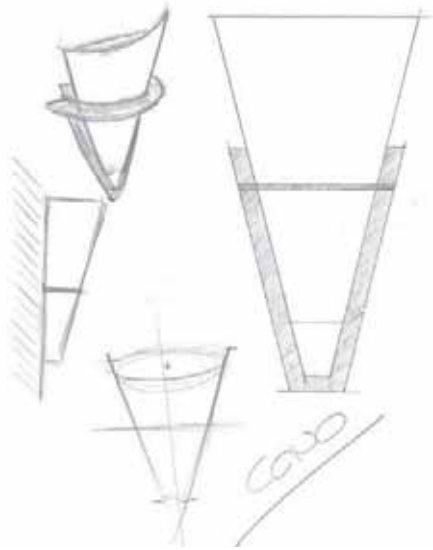

CONO

Faro
Team

Un cristal arenoso y una estructura de metal en marrón óxido confieren a este modelo una rústica apariencia.

Du verre sablé et une structure en métal couleur rouille confèrent à ce modèle un aspect rustique.

Sanded glass and a rust brown metallic structure give this model a rustic appearance.

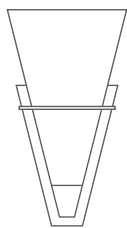



OUTDOOR

INDEX BY SECTIONS

Índice por secciones

Index par sections

PENDANT LAMPS

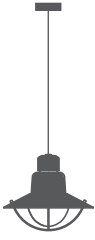

NEWPORT
104

CEILING LAMPS



CROSS
124



TRIAL
132

WALL LAMPS



ÁNCORA
148



BIRD
80



BLUB'S
112



BOLETUS
128



CERES
156



CODE
136



CROSS
124



DATNA
88



DRAGMA
152



FUTURE
140



KLAMP
100



MISTU
120



MOON
108



MUFFIN
116



NEWPORT
104



PROA
144



RATTAN
160



SENTINEL
96



STEPS
84



TRIAL
132



YAK
92

PROJECTORS



PROJECT
164

POST LAMPS



BLUB'S
112



BOLETUS
128



CROSS
124



MISTU
120



MOON
108



MUFFIN
116



TRIAL
132

BEACONS



BIRD
80



BLUB'S
112



BOLETUS
128



CROSS
124



DATNA
24



KLAMP
100



MISTU
120



MOON
108



MUFFIN
116



SENTINEL
96



STEPS
84



TRIAL
132



YAK
92

TABLE LAMPS



MISTU
120



VERSUS
168

PORTABLES



CROSS
124



NUK
172

POLE LAMPS



BLUB'S
112



BOLETUS
128



CROSS
124



MISTU
120

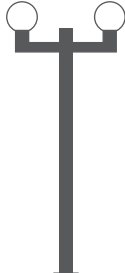

MOON
108

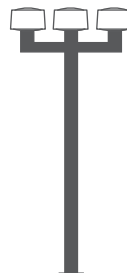

MUFFIN
116

BIRD



Estudi
Ribaudí





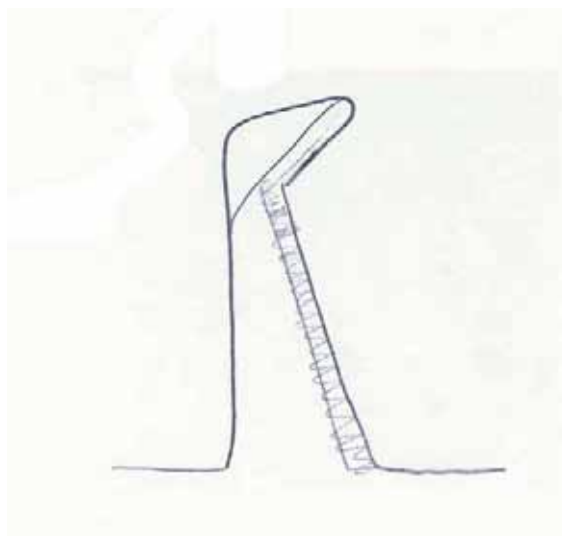

BIRD is a beacon inspired by Japanese origami, a culture that sought permanent harmony in open spaces.

BIRD

Estudi
Ribaudí

BIRD es una baliza inspirada en la papiroflexia japonesa, una cultura que buscaba la permanente armonía en sus espacios abiertos.

BIRD est une balise inspirée de l'origami japonais, une culture à la recherche d'une harmonie permanente dans ses espaces ouverts.

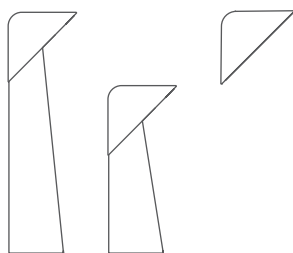

 pag 178 

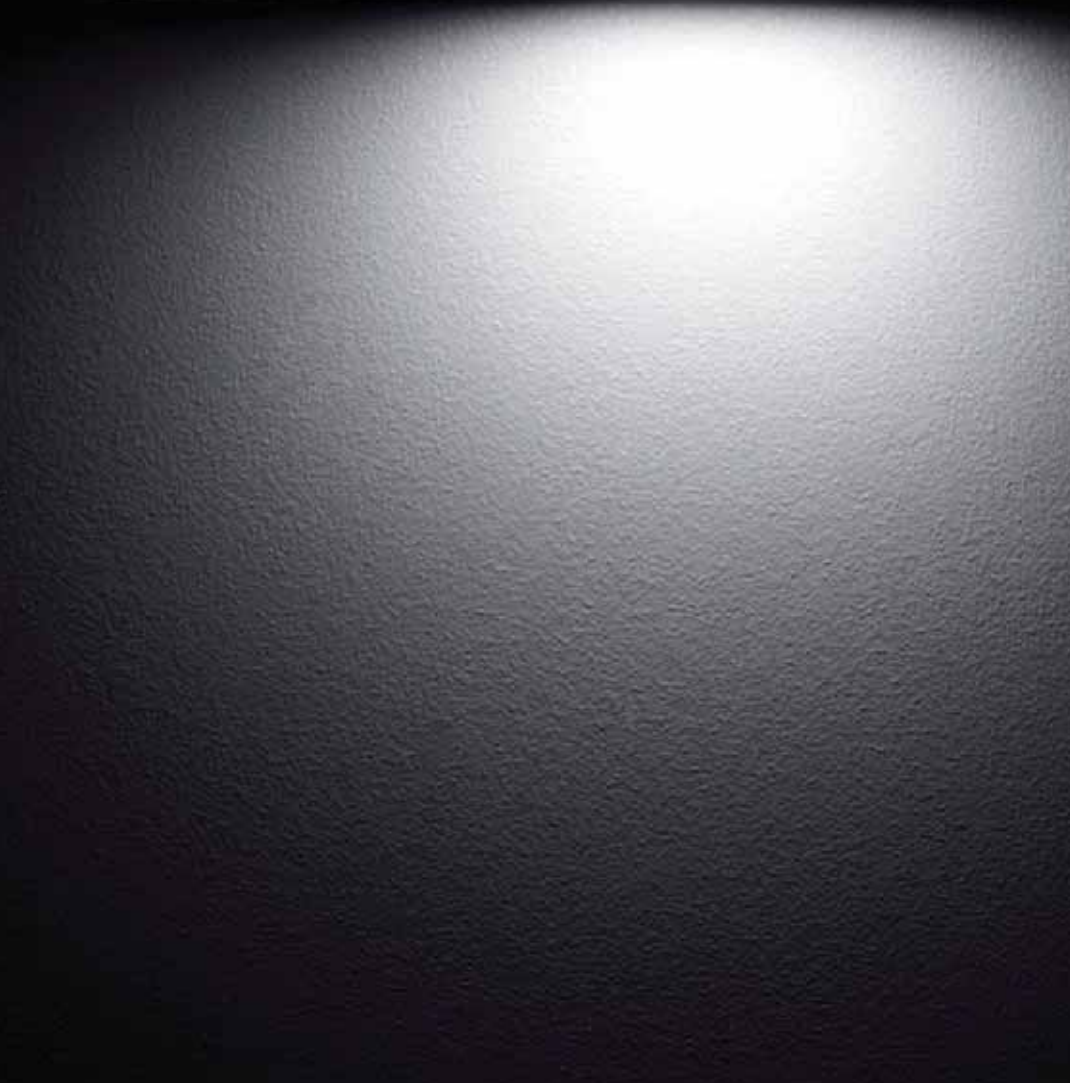

STEPS



Estudi
Ribaudí





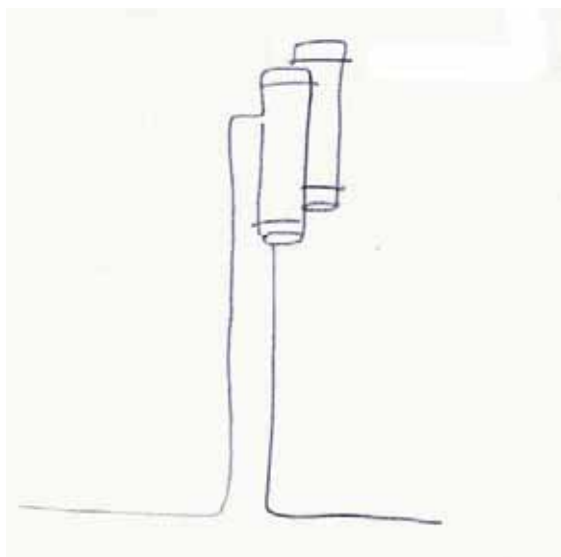

STEPS is a tubular composition that gives a growing sensation in the space. A set of upper and lower lights accentuates this feeling.

STEPS

Estudi
Ribaudí

STEPS es una composición tubular que provoca una sensación creciente en el espacio. Su juego de luces superior e inferior acentúa esta sensación.

STEPS est une composition tubulaire qui crée une impression d'agrandissement de l'espace. Son jeu de lumières vers le haut et le bas accentue cette impression.

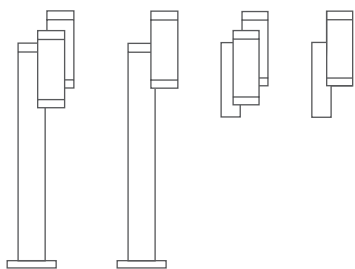



DATNA



Manel
Lluscà





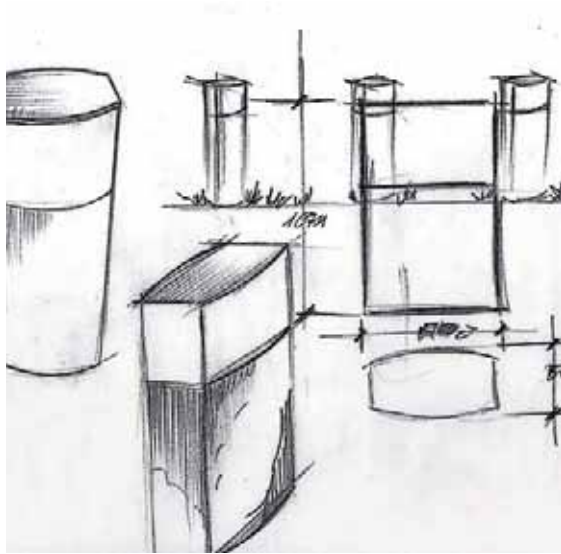

Seeking integration with the urban landscape and new the architecture, we provide a minimalist design with a single volume.

DATNA

Manel
Lluscà

Buscando integración con el paisaje urbano y la nueva arquitectura, aportamos diseño de línea minimalista y volumen monolítico.

En recherchant l'intégration au paysage urbain et à la nouvelle architecture, nous proposons un design aux lignes épurées et un volume monolithique.

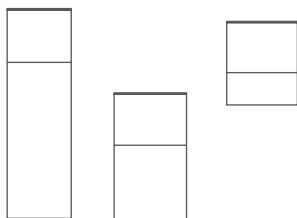



YAK



Manel
Lluscà





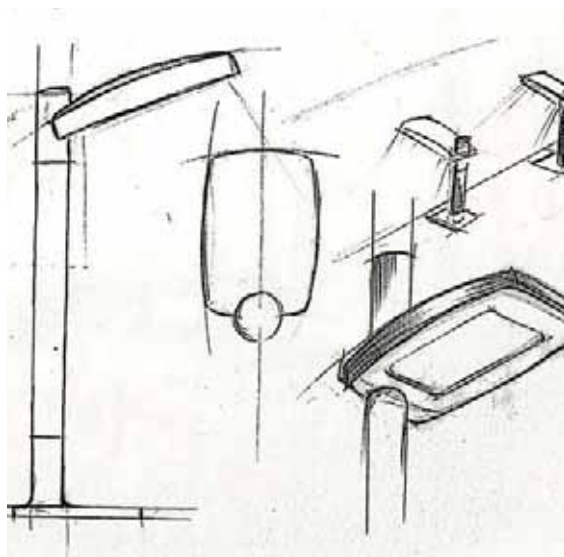

Minimising space and achieving new unconventional shapes through the use of LED technology. The simplicity of lines, the intersection of volumes and the roundness of its edges caress the space around it.

YAK

Manel
Lluscà

Minimizar el espacio y conseguir nuevas formas no convencionales gracias al uso de la tecnología LED. La sencillez de líneas, la intersección de volúmenes y la redondez de sus aristas acarician el espacio que la envuelve.

Minimiser l'espace occupé et obtenir de nouvelles formes non conventionnelles grâce à l'utilisation de la technologie LED. La simplicité des lignes, l'intersection des volumes et la rondeur de ses arêtes épousent l'espace qui l'entoure.

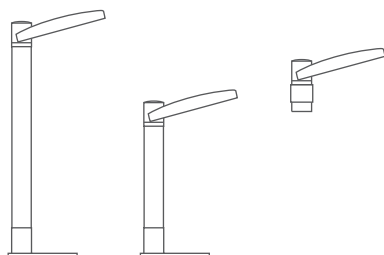



SENTINEL



Estudi
Ribaudí







SENTINEL comes from the synthesis of form, and the result provides us with a collection of soft shapes with real personality.

SENTINEL

Estudi
Ribaudí

SENTINEL nace de un ejercicio de síntesis de la forma, que como resultado nos ofrece una colección de formas suaves y de marcadas personalidad.

SENTINEL est le fruit d'un exercice de synthèse de la forme, un ensemble de formes douces avec une forte personnalité.

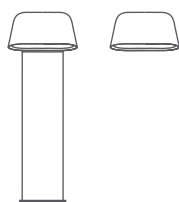

i pag 198



KLAMP



Manel
LLuscà





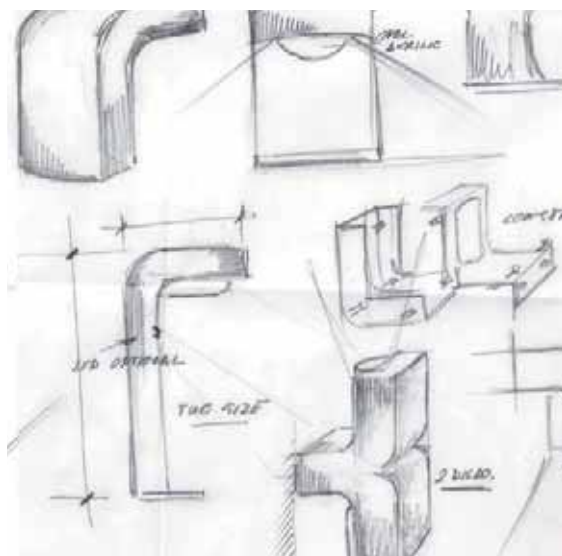

Aesthetics and functionality come together in this serie of contemporary and stylish lines. The beacons are available with a light sensor to provide maximum comfort and safety to the user.

KLAMP

Manel
Lluscà

Estética y funcionalidad se dan la mano en esta serie de líneas contemporáneas y estilizadas. Las balizas están disponibles con sensor de luz para ofrecer mayor comodidad y seguridad al usuario.

Esthétique et fonctionnalité sont réunies dans cette série aux lignes contemporaines et épurées. Les balises sont disponibles avec un capteur de lumière pour offrir un maximum de confort et de sécurité à l'utilisateur.

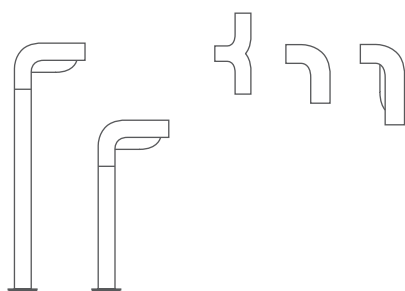



NEWPORT



Estudi
Ribaudí





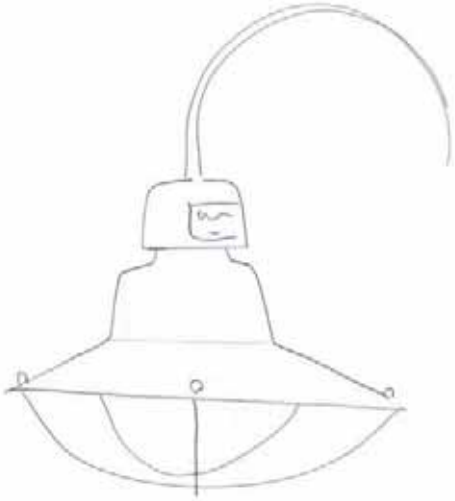

NEWPORT is a lamp that evokes a come back to authentic and intimate objects. It carries us to the romanticism of the beginning of the century ... A timeless appearance beyond fashion.

NEWPORT

Estudi
Ribaudí

NEWPORT es una lámpara que se inspira en el retorno a los objetos auténticos y entrañables. Nos transporta al romanticismo de principios de siglo... A una estética atemporal y fuera de toda moda.

NEWPORT est un luminaire inspiré du retour aux objets authentiques et émouvants. Il nous ramène au romantisme du début du siècle... à une esthétique intemporelle au-delà de la mode.

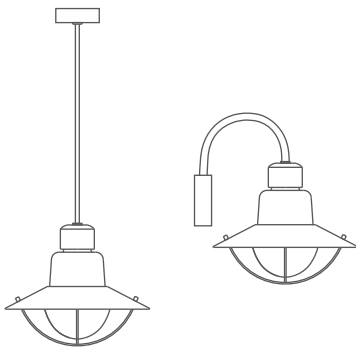

i pag 195



MOON



Faro
Team







It is the search for the essence of light, and for simplicity of shapes. A full moon that floods everything around with light.

MOON

Faro
Team

Es la búsqueda de la esencia de la luz, la simplicidad en la forma. Un plenilunio que inunda de luz todo a su alrededor.

La recherche de l'essence de la lumière et de la simplicité de la forme. Une pleine lune qui inonde de lumière tout ce qui l'entoure.

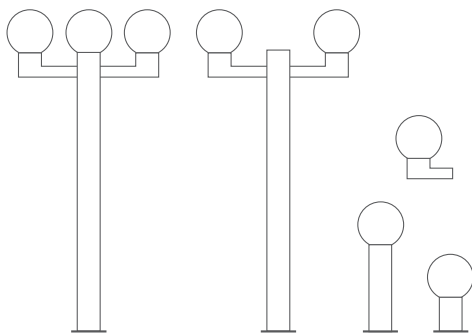



BLUB'S



Estudi
Ribaudí





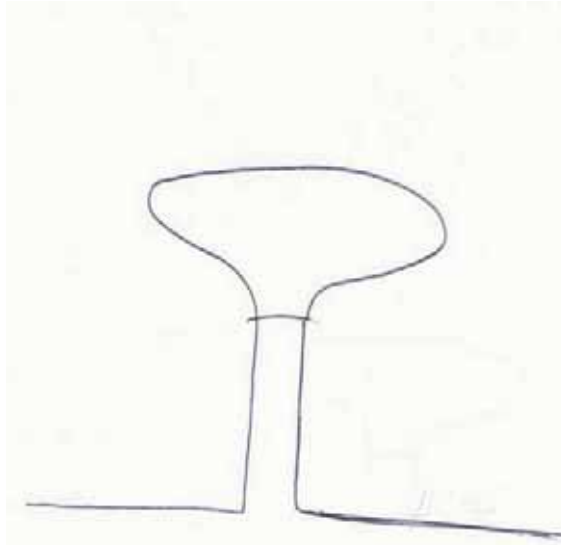

BLUBS is like a bubble of air surging from the earth. Its shapes are softened by light and fill the space in a simple and structured way.

BLUB'S

Estudi
Ribaudí

BLUBS es como una burbuja de aire que emana de la tierra; sus formas se difuminan con la luz y complementan el espacio de una forma simple y ordenada.

BLUBS est comme une bulle d'air qui émane de la terre ; ses formes s'estompent avec la lumière et complètent l'espace de manière simple et ordonnée.

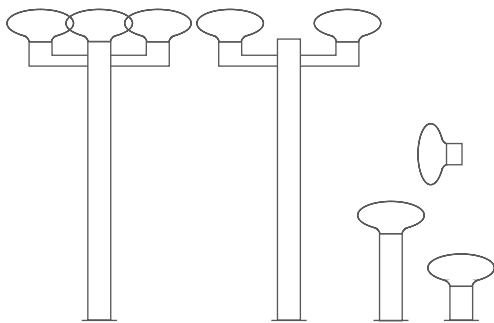



MUFFIN



Manel
LLuscà





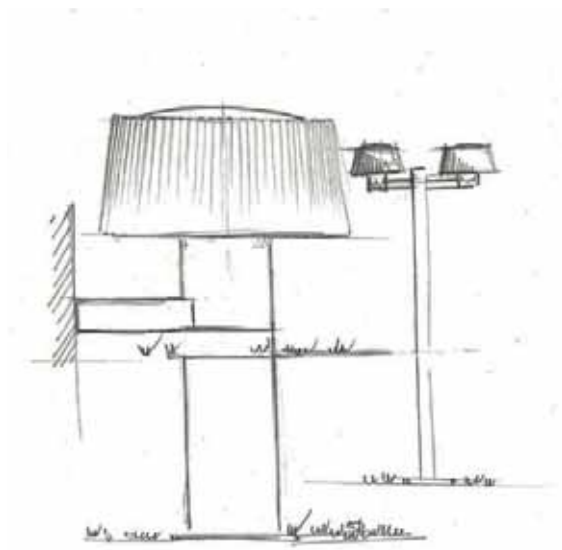

A series with a fun and informal die casting aluminium design with a pleated white opal PMMA shade. A timeless proposal capable of fitting into various outdoor ambience.

MUFFIN

Manel
Lluscà

Una serie de diseño divertido e informal realizada en aluminio inyectado y pantalla blanca plisada de PMMA opal. Una propuesta de estilo atemporal capaz de encajar en diferentes exteriores.

Une série au design ludique et informel en fonte d'aluminium avec abat-jour blanc plissé en PMMA opaque. Une option au style intemporel capable de s'intégrer à différents extérieurs.

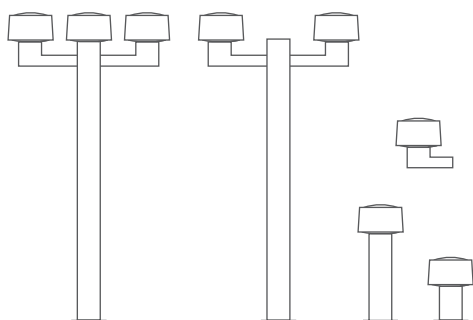



MISTU



Faro
Team





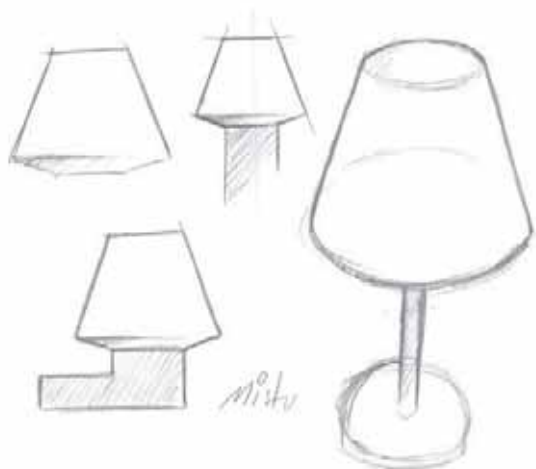

Pleasant design for a highly versatile series. A polymethacrylate (PMMA) diffuser provides an excellent and perfectly proportioned light.

MISTU

Faro
Team

Simpático diseño para una serie de gran versatilidad. Un difusor de polimetacrilato (PMMA) procura una excelente luz, perfectamente tamizada.

Un design agréable pour une série très polyvalente. Un diffuseur en polyméthacrylate de méthyle (PMMA) procure une lumière exquise, parfaitement tamisée.

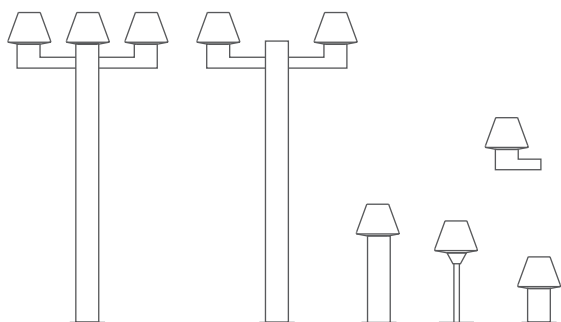



CROSS



Manel
LLuscà





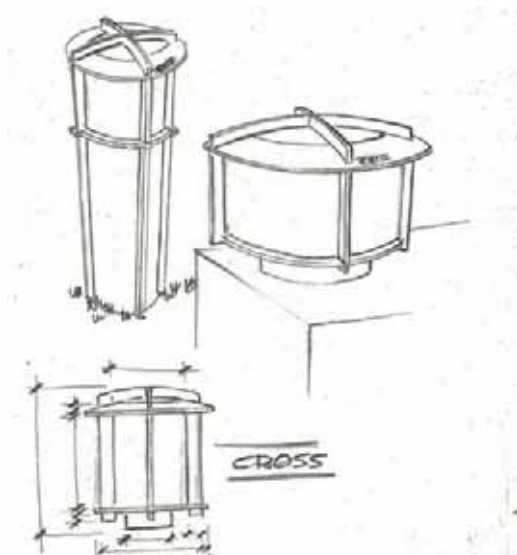

Made of die casting aluminium and polycarbonate, the CROSS serie is ideal for both contemporary and classic environments and has a wide range of lighting solutions which provide greater versatility.

CROSS

Manel
Llusçà

Realizada en aluminio inyectado y policarbonato, la serie CROSS es ideal tanto para ambientes actuales como clásicos y dispone de una amplia oferta de soluciones lumínicas confiriéndole mayor versatilidad.

Fabriquée en fonte d'aluminium et en polycarbonate, la série CROSS est idéale tant dans les espaces modernes que dans les environnements classiques. Elle offre une vaste gamme de solutions d'éclairage qui la rendent très polyvalente.

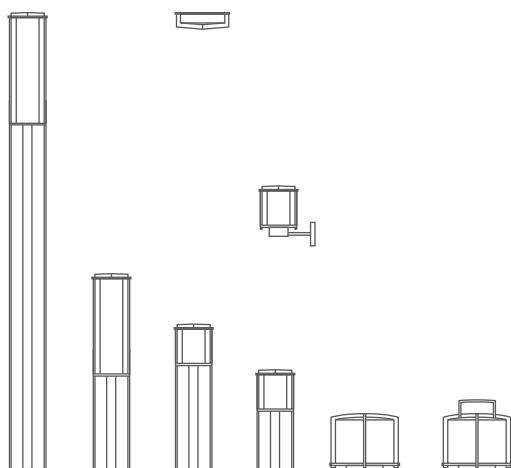



BOLETUS



Manel
Lluscà





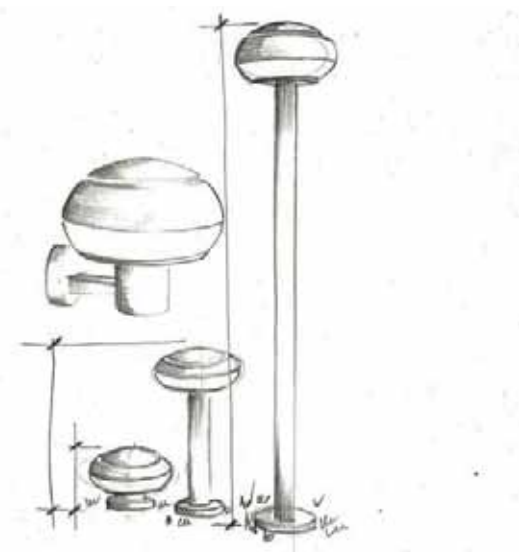

With a modern design and rounded lines, BOLETUS provides indirect and nuanced light thanks to its opal polycarbonate diffuser and the slot in the top of the shade.

BOLETUS

Manel
Lluscà

Con un diseño moderno y de líneas redondeadas, BOLETUS proporciona luz indirecta y matizada gracias a su difusor de policarbonato opal y a la ranura superior situada en su pantalla.

Avec son design moderne et ses lignes arrondies, BOLETUS apporte une lumière indirecte et nuancée grâce à son diffuseur en polycarbonate opaque et à l'ouverture située sur le dessus.

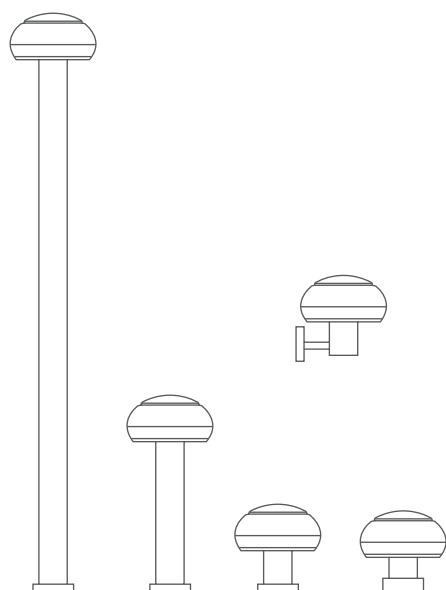



TRIAL



Manel
Lluscà





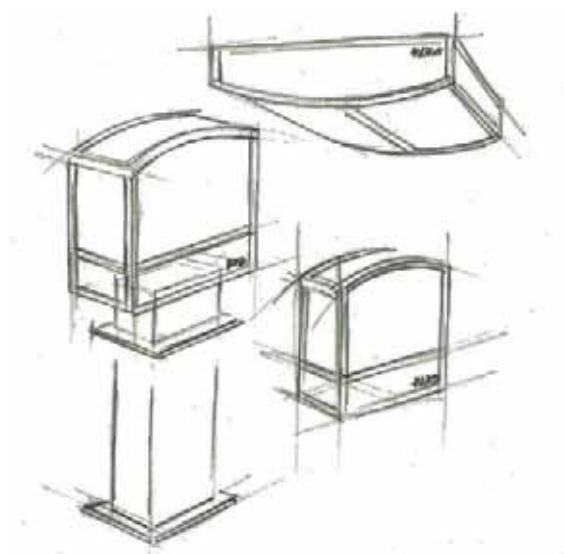

The formal and simple design of this serie is reminiscent of those well-known American mailboxes combining straight lines with a slight curve at the top.

TRIAL

Manel
Lluscà

Con un diseño formal y sobrio, esta serie nos remite a los tan conocidos buzones americanos que combinan líneas rectas con una línea ligeramente arqueada en su parte superior.

D'un design sérieux et sobre, cette série rappelle les célèbres boîtes aux lettres américaines qui allient des lignes droites et une ligne légèrement arquée sur le dessus.

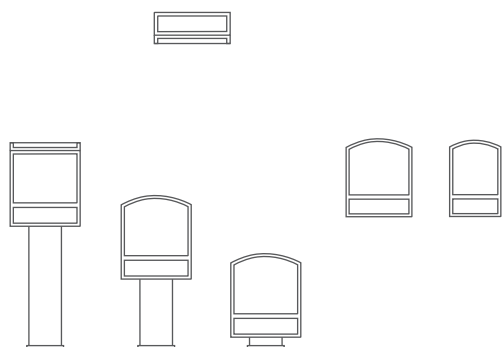



CODE



Estudi
Ribaudí





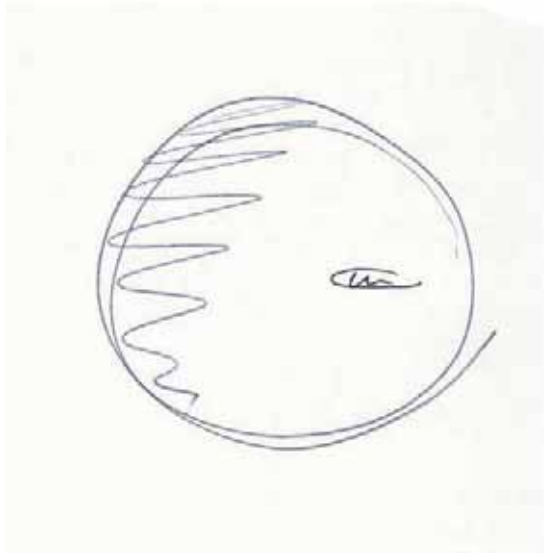

CODE

Estudi
Ribaudí

CODE es un eclipse de luz, un camino de círculos concéntricos que nos acompañan de una forma casi imperceptible.

CODE est une éclipse de lumière, un chemin de cercles concentriques qui nous accompagnent de manière presque imperceptible.

CODE is an eclipse of light, a path of concentric circles that accompany us almost unnoticed.

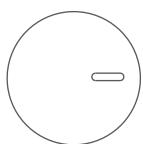

i pag 181



3 STICKERS INCL.





FUTURE



Estudi
Ribaudí





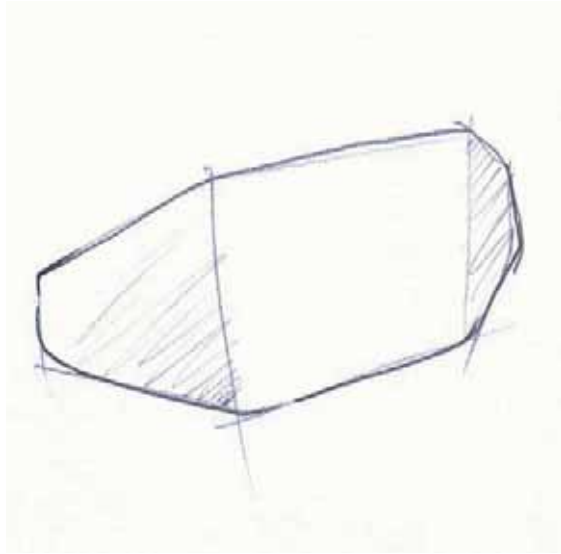

FUTURE is an outdoor fixture characterised by an attractive and decorative set of indirect lights. Its smooth, flat oblong shape blend into its surroundings.

FUTURE

Estudi
Ribaudí

FUTURE es un aplique para exteriores que se caracteriza por un atractivo y decorativo juego de luz indirecta. Su forma suave y apaisada genera un efecto mimético con su entorno.

FUTURE est une applique extérieure caractérisée par un jeu de lumière indirecte esthétique et décoratif. Sa forme douce et oblongue crée un effet de mimétisme avec son environnement.



i pag 186

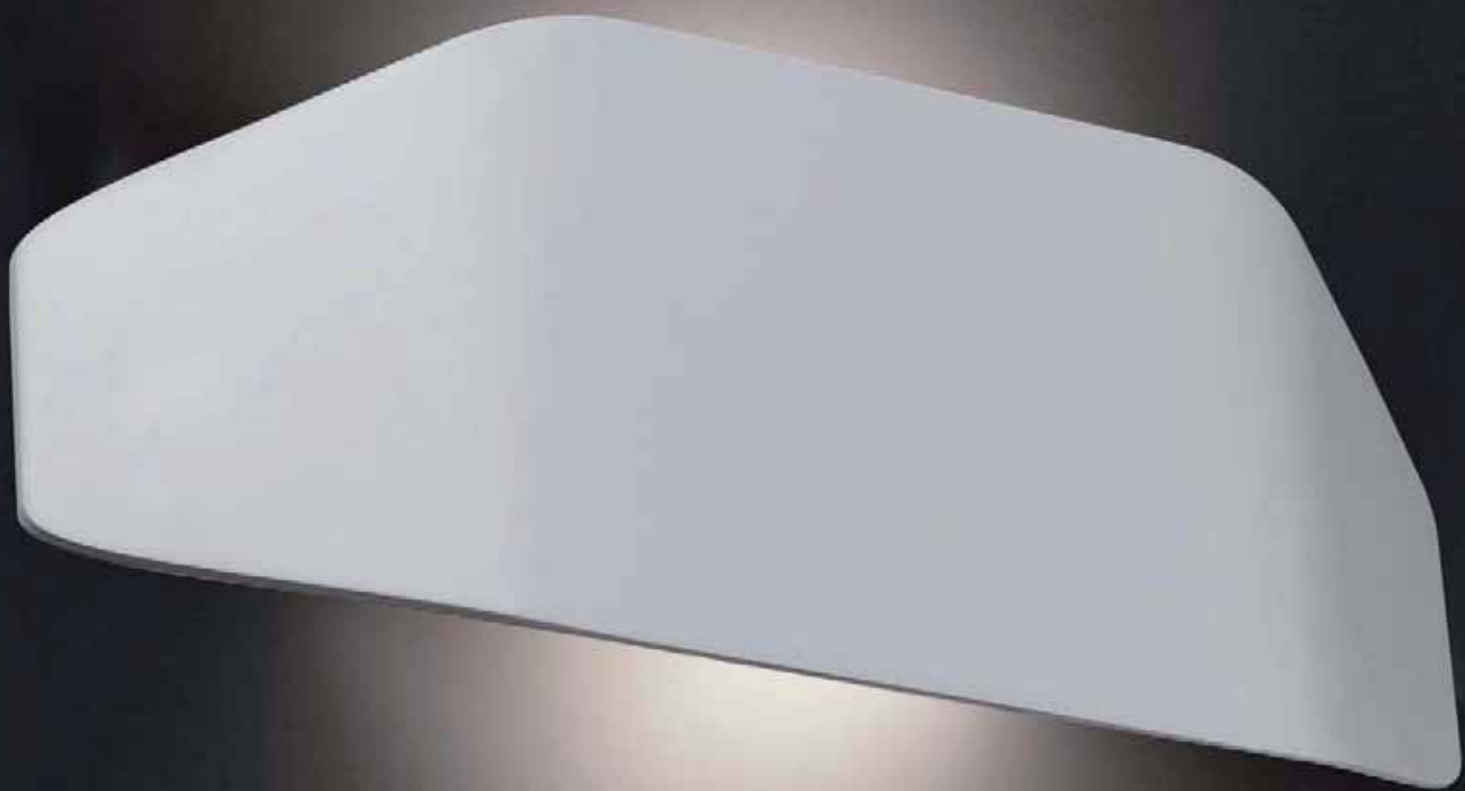

PROA



Manel
Lluscà





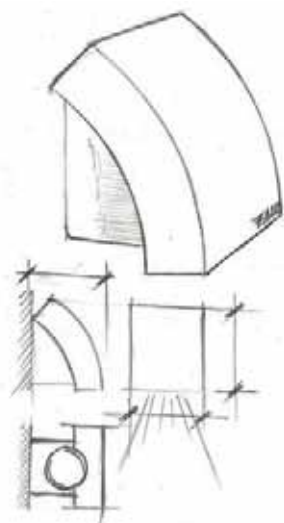

A modern, compact design in die casting aluminium for a wall fixture intended for signposting. Also available in LED version.

PROA

Manel
Lluscà

Un diseño moderno y compacto realizado en aluminio inyectado para un aplique de pared destinado a la señalética. Disponible también en versión LED.

Un design moderne et compact en fonte d'aluminium pour une applique murale destinée à la signalétique. Également disponible en LED.





ÀNCORA

Manel
Lluscà





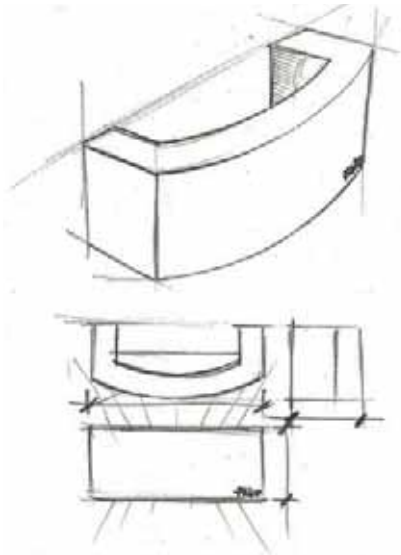

A die casting aluminium structure protects the light source in this fixture, emitting indirect light up and downwards and bathing the surface on which it is fitted.

ÁNCORA

Manel
Lluscà

Una estructura realizada en aluminio inyectado resguarda la fuente lumínica de este aplique, emitiendo luz indirecta arriba y abajo y bañando la superficie sobre la que está ubicado.

Une structure en fonte d'aluminium protège la source lumineuse de cette applique qui émet une lumière indirecte à la fois vers le haut et vers le bas et éclaire toute la surface sur laquelle elle se trouve.





DRAGMA



Manel
Lluscà





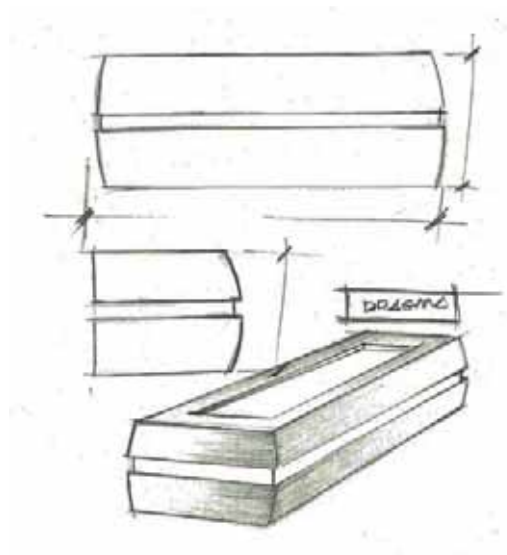

Sober and functional. This is DRAGMA, a wall fixture that integrates into space thanks to its versatility: it can direct light upwards, downwards or both at once.

DRAGMA

Manel
Lluscà

Sobrio y funcional. Así es DRAGMA, un aplique de pared que se integra en el espacio gracias a su versatilidad: puede iluminar arriba, abajo o a ambos lados a la vez.

Sobre et fonctionnelle. DRAGMA, une applique murale qui s'intègre dans l'espace grâce à sa polyvalence: elle peut éclairer vers le haut et/ou le bas en même temps.

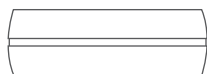



CERES



Manel
Lluscà





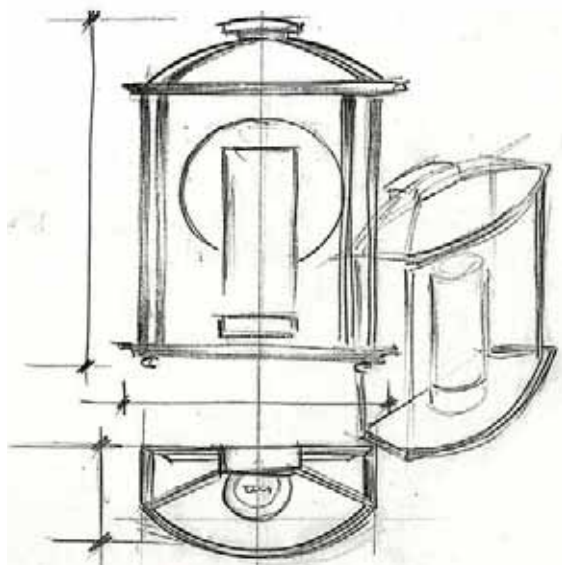

Steeped in the atmosphere of the “Châteaux de la Loire”, these models achieve a very specific French style that will never be out of date.

CERES

Manel
Lluscà

Sumergidos en la atmósfera que se recrea en los castillos del Valle del Loire, hemos conseguido estos modelos de un estilo muy particular, afrancesado y eternamente actual.

Plongés dans l’atmosphère des châteaux de la Loire, nous sommes parvenus à créer ces modèles au style très particulier, francisé et éternellement actuel.

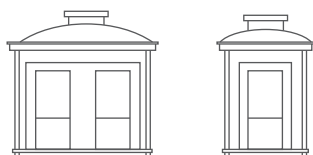



RATTAN



Manel
Lluscà





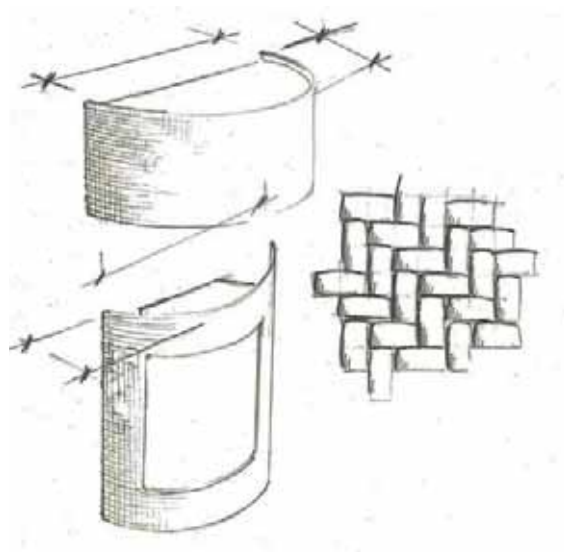

A series made with rattan, an ideal material for outdoor areas as it is decorative but also provides high resistance to adverse weather conditions.

RATTAN

Manel
Lluscà

Serie realizada en rattan, un material ideal para zonas exteriores ya que es decorativo y ofrece una alta resistencia a condiciones meteorológicas adversas.

Gamme fabriquée en rotin, un matériau idéal pour les espaces extérieurs puisqu'il est décoratif mais offre également une haute résistance aux conditions météorologiques adverses.

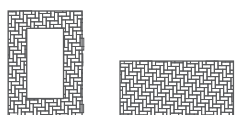
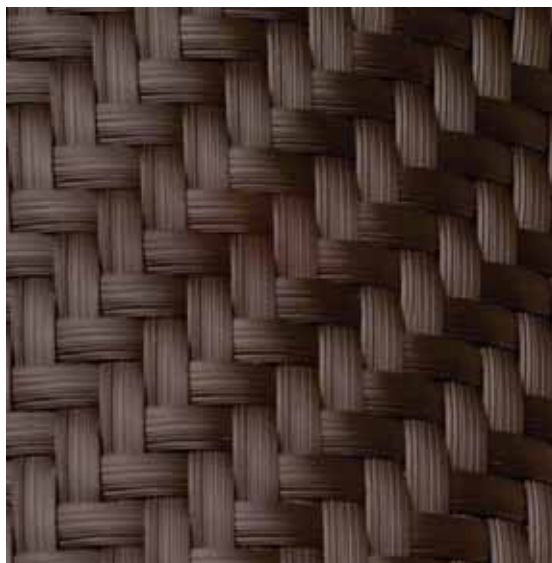



PROJECT

Manel
Lluscà





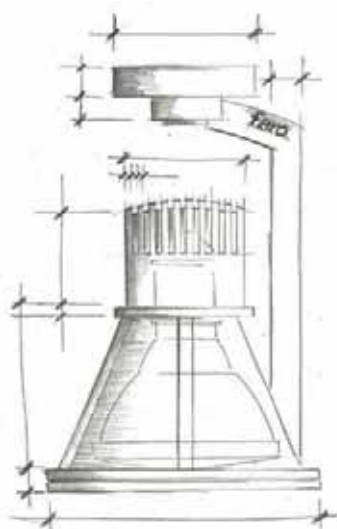

Projector made in die casting aluminum and available in two sizes and two different finishes. It is fully orientable both vertically and horizontally.

PROJECT

Manel
LLuscà

Projector realizado en aluminio inyectado y disponible en dos tamaños y acabados distintos. Es totalmente orientable, tanto vertical como horizontalmente.

Projecteur en aluminium injecté. Modèles disponibles en deux diverses dimensions et en deux couleurs. Vous pouvez l'orienter comme vous le souhaitez, aussi bien horizontalement que verticalement.

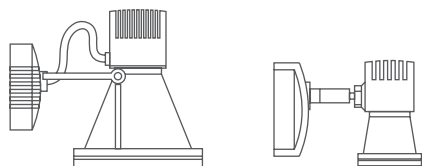
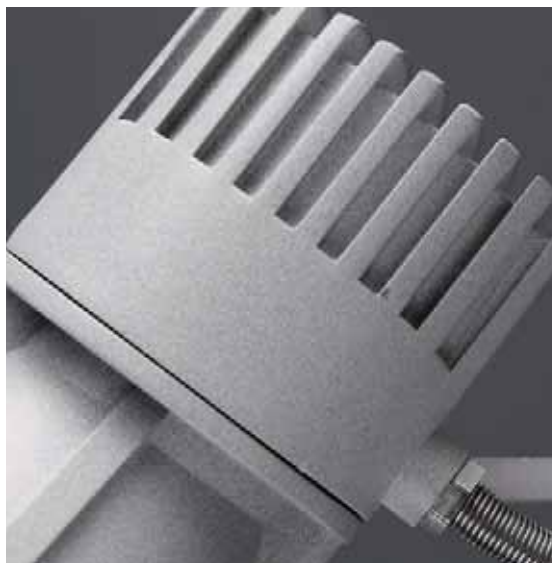



VERSUS



Pepe
LLaudet







Simple, easily-integrated and versatile. A contemporary object with a classic geometrical design formed from two conical elements of the same type and material, to form a single, unique lighting element. Made of polyethylene and rated IP44.

VERSUS

Pepe
Llaudet

Simple, integrable y versátil. Objeto contemporáneo y de geometría clásica que se forma a partir de dos elementos cónicos del mismo material y naturaleza unidos formando un solo elemento lumínico singular. Realizado en polietileno y con IP44.

Simple, facile à intégrer et polyvalent. Objet contemporain à la géométrie classique composé de deux éléments coniques de même matière et de la même nature unis pour ne former qu'un seul et même luminaire original. Fabriqué en polyéthylène, indice de protection IP44.

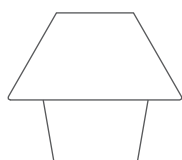

 pag 202 



NUK



Manel
LLuscà







NUK

Manel
Lluscà

Llega la distensión y el disfrute de la mano de NUK, una lámpara portátil altamente decorativa pensada para disfrutar plenamente de la vida en el exterior.

La détente et le plaisir viennent de la main de NUK, une lampe très décoratif portable destiné à profiter pleinement de la vie en extérieur.

Relaxation and enjoyment come with NUK, a highly decorative portable lamp intended to fully enjoy life in the outdoors.

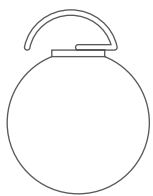
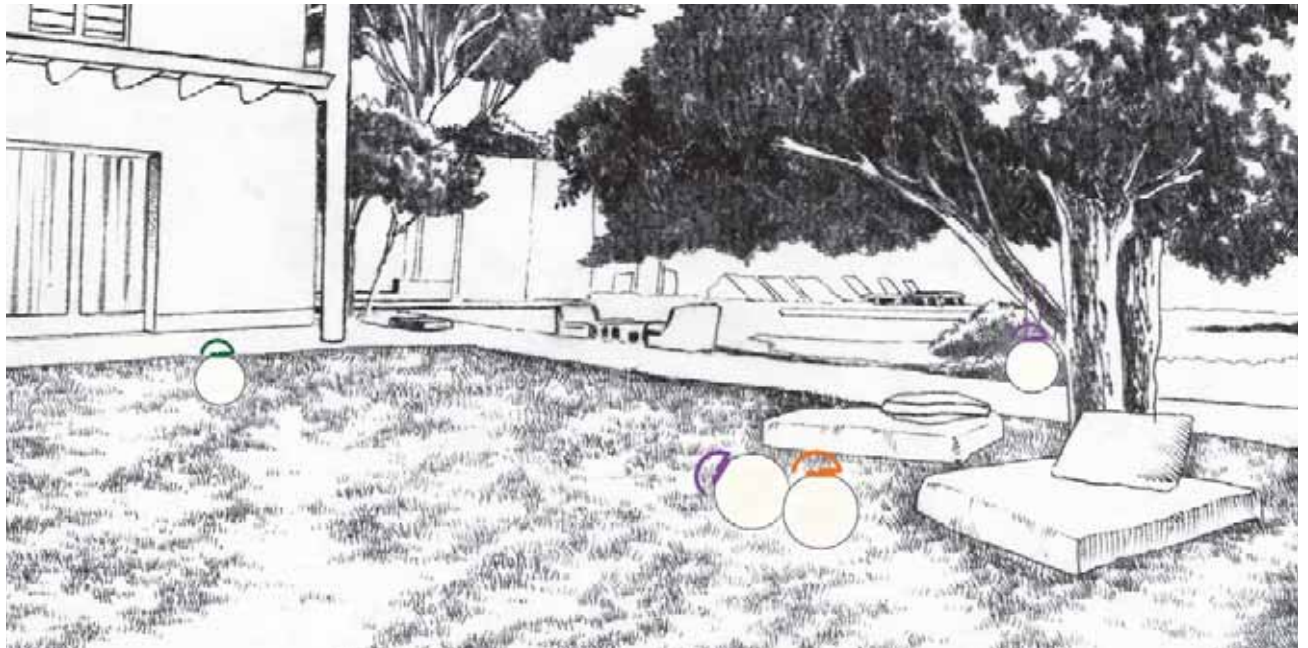





A

ÁNCORA 178

B

BIRD 178

BLUBS 179

BOLETUS 180

C

CERES 181

CODE 181

CONO 181

CROSS 182

D

DATNA 184

DRAGMA 184

E

ETERFAN 184

F

FARETTO 185

FLEXI 185

FOKUS 186

FUTURE 186

H

HOTEL 187

K

KLAMP 188

L

LINDA 189

LINK 190

M

MISTU 191

MIX 192

MOON 193

MUFFIN 194

N

NEWPORT 195

NEXO 195

NUK 195

P

PÉRGAMO 196

PROA 196

PROJECT 196

R

RATTAN 196

S

SAC 197

SENTINEL 198

STEPS 198

SWEET 199

T

TREE 200

TRIAL 201

TWIN 202

V

VERSUS 202

W

WINCH 202

Y

YAK 203

ÁNCORA

Manel
LLusçà

OUT
DOOR



pag 148

pag 206

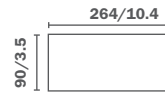

WALL LAMP	Finish	Reference	Material	Bulb	Gear	Weight	IP	Class
	DARK GREY	74401	DIE CAST AL/OPAL POLYC	1xE27 MAX 20W NOT INCL. [16467]	-	0.87Kg/ 1.9lb	44	⊕

BIRD

OUT
DOOR



pag 80

Estudi
Ribaudi

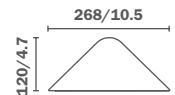
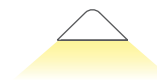

WALL LAMP	Finish	Reference	Material	Bulb	Gear	Weight	IP	Class
	WHITE	75509	DIE CAST AL/TRANSL POLYC	1xE27 MAX 20W NOT INCL. [16466]	-	1.2Kg/ 2.6lb	44	⊕
	WHITE ALUMINIUM	75510	DIE CAST AL/TRANSL POLYC	1xE27 MAX 20W NOT INCL. [16466]	-	1.2Kg/ 2.6lb	44	⊕
	BLACK	75511	DIE CAST AL/TRANSL POLYC	1xE27 MAX 20W NOT INCL. [16466]	-	1.2Kg/ 2.6lb	44	⊕

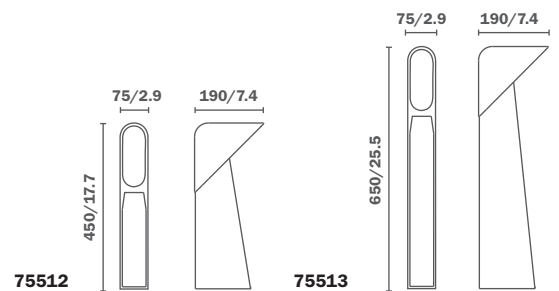

BEACON	Finish	Reference	Material	Bulb	Gear	Weight	IP	Class
	BLACK	75512	DIE CAST AL/TRANSL POLYC	1xE27 MAX 20W NOT INCL. [16466]	-	2.5Kg/ 5.5lb	44	⊕
	BLACK	75513	DIE CAST AL/TRANSL POLYC	1xE27 MAX 20W NOT INCL. [16466]	-	3.5Kg/ 7.7 lb	44	⊕

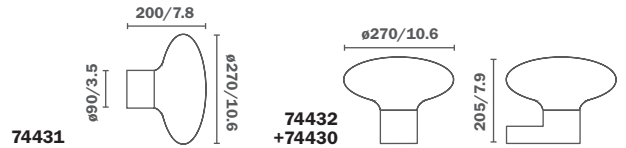

WALL LAMP	Finish	Reference	Material	Bulb	Gear	Weight	IP	Class
	DARK GREY WHITE	74431	DIE CAST AL/OPAL PMMA	1xE27 MAX 20W NOT INCL. [16466]	-	1.1Kg/ 2.4lb	44	
	DARK GREY WHITE	74432 +74430	DIE CAST AL/OPAL PMMA	1xE27 MAX 20W NOT INCL. [16466]	-	1.2Kg/ 2.5lb	44	

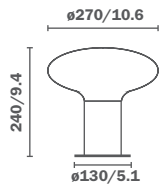

POST LAMP	Finish	Reference	Material	Bulb	Gear	Weight	IP	Class
	DARK GREY WHITE	74433 +74430	DIE CAST AL/OPAL PMMA	1xE27 MAX 20W NOT INCL. [16466]	-	2.2Kg/ 4.8lb	44	

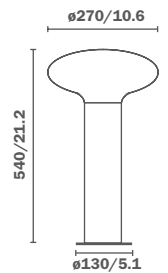

BEACON	Finish	Reference	Material	Bulb	Gear	Weight	IP	Class
	DARK GREY WHITE	74434 +74430	DIE CAST AL/OPAL PMMA	1xE27 MAX 20W NOT INCL. [16466]	-	1.9Kg/ 4.2lb	44	

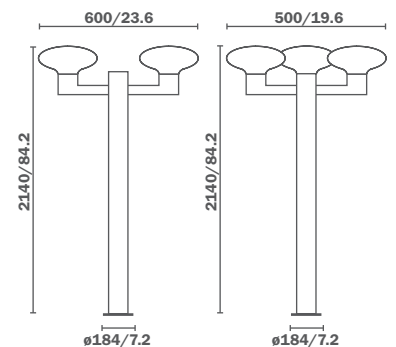

POLE LAMP	Finish	Reference	Material	Bulb	Gear	Weight	IP	Class
	DARK GREY WHITE	74435 +74430 (2 units)	DIE CAST AL/ OPAL PMMA	2xE27 MAX 20W NOT INCL. [16466]	-	8.7Kg/ 19.1lb	44	
	DARK GREY WHITE	74436 +74430 (3 units)	DIE CAST AL/ OPAL PMMA	3xE27 MAX 20W NOT INCL. [16466]	-	10.6Kg/ 23.3lb	44	

BOLETUS

OUT
DOOR



pag 128

Manel
LLuscà

pag 206

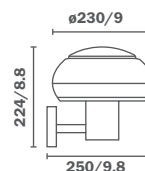

WALL LAMP	Finish	Reference	Material	Bulb	Gear	Weight	IP	Class
	DARK GREY	74391	DIE CAST AL/OPAL POLYC	1xE27 MAX 20W NOT INCL. [16467]	-	1.6Kg/ 3.5lb	44	⊕

pag 206

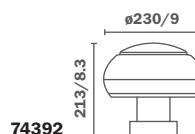

74392

74393

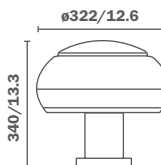

POST LAMP	Finish	Reference	Material	Bulb	Gear	Weight	IP	Class
	DARK GREY	74392	DIE CAST AL/OPAL POLYC	1xE27 MAX 20W NOT INCL. [16467]	-	1.6Kg/ 3.5lb	44	⊕
	DARK GREY	74393	DIE CAST AL/OPAL POLYC	3xE27 MAX 20W NOT INCL. [16467]	-	3.1Kg/ 6.8lb	44	⊕

pag 206

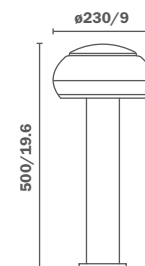

BEACON	Finish	Reference	Material	Bulb	Gear	Weight	IP	Class
	DARK GREY	74394	DIE CAST AL/OPAL POLYC	1xE27 MAX 20W NOT INCL. [16467]	-	2.16Kg/ 4.8lb	44	⊕

pag 206



POLE LAMP	Finish	Reference	Material	Bulb	Gear	Weight	IP	Class
	DARK GREY	74395	DIE CAST AL/OPAL POLYC	3xE27 MAX 20W NOT INCL. [16467]	-	9.5Kg/ 20.9lb	44	⊕

CERES

OUT
DOOR



pag 156

Manel
LLusçà

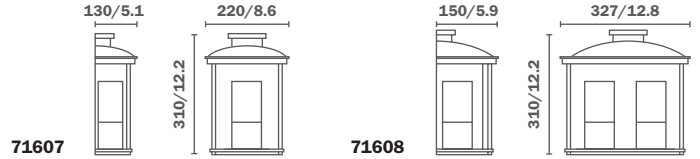

WALL LAMP	Finish	Reference	Material	Bulb	Gear	Weight	IP	Class
	BLACK	71607	DIE CAST/OPAL POLYC/ TRANSP GLASS	1xE27 MAX 20W NOT INCL. [16466]	-	2.1Kg/ 4.6lb	44	
	BLACK	71608	DIE CAST/OPAL POLYC/ TRANSP GLASS	2xE27 MAX 20W NOT INCL. [16466]	-	3.5Kg/ 7.7lb	44	

CODE

OUT
DOOR



pag 136

Estudi
Ribaudí

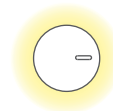

3 STICKERS INCL.

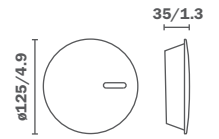

WALL LAMP	Finish	Reference	Material	Bulb	Gear	Weight	IP	Class
LED	WHITE	71526	POLYC	9 LED 2W 150 Lm 4000K INCL.	DRIVER INCL.	0.14Kg/ 0.3lb	44	
LED	DARK GREY	71527	POLYC	9 LED 2W 150 Lm 4000K INCL.	DRIVER INCL.	0.14Kg/ 0.3lb	44	

CONO

IN
DOOR



pag 74

Faro
Team

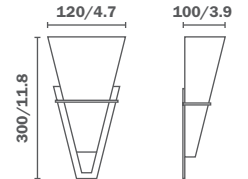

WALL LAMP	Finish	Reference	Material	Bulb	Gear	Weight	IP	Class
	RUST	66137	MET/RUSTIC GLASS	2xE14 MAX 60W NOT INCL. [16291]	-	1.5Kg/ 3.3lb	20	

CROSSOUT
DOOR

pag 124

Manel
LLuscà

pag 206

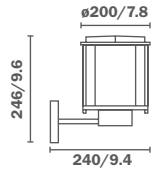

WALL LAMP	Finish	Reference	Material	Bulb	Gear	Weight	IP	Class
	DARK GREY	74350	DIE CAST ALU/OPAL POLYC	1xE27 MAX 60W NOT INCL. [16467]	-	1.8Kg/ 4lb	65	

Optional antipollution light kit ref. 74369

pag 206

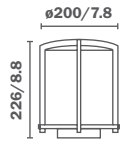

POST LAMP	Finish	Reference	Material	Bulb	Gear	Weight	IP	Class
	DARK GREY	74351	DIE CAST ALU/OPAL POLYC	1xE27 MAX 60W NOT INCL. [16467]	-	1.55Kg/ 3.4lb	65	

Optional antipollution light kit ref. 74369

pag 206

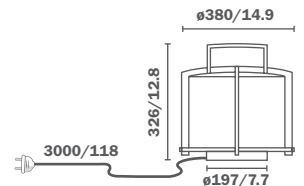

PORTABLE	Finish	Reference	Material	Bulb	Gear	Weight	IP	Class
	DARK GREY	74353	DIE CAST ALU/OPAL POLYC	1xE27 MAX 100W NOT INCL. [16467]	-	4.4Kg/ 9.7lb	65	

pag 206

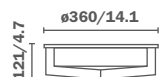

CEILING LAMP	Finish	Reference	Material	Bulb	Gear	Weight	IP	Class
	DARK GREY	74355	DIE CAST ALU/OPAL POLYC	2xE27 MAX 20W NOT INCL. [16467]	-	2.2Kg/ 4.8lb	54	

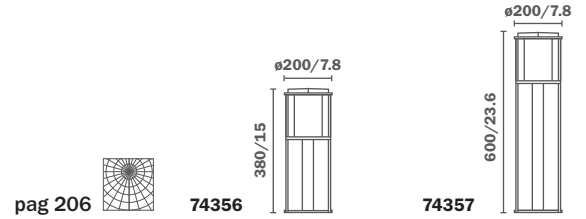

BEACON	Finish	Reference	Material	Bulb	Gear	Weight	IP	Class
	DARK GREY	74356	DIE CAST ALU/OPAL POLYC	1xE27 MAX 60W NOT INCL. [16467]	-	3Kg/ 6.6lb	65	⊕
	DARK GREY	74357	DIE CAST ALU/OPAL POLYC	1xE27 MAX 60W NOT INCL. [16467]	-	4.6Kg/ 10.1lb	65	⊕

Optional antipollution light kit ref. 74369

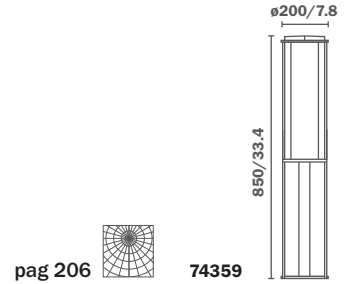

BEACON	Finish	Reference	Material	Bulb	Gear	Weight	IP	Class
	DARK GREY	74359	DIE CAST ALU/OPAL POLYC	1xPL2G11 36W INCL.	INCL.	5.97Kg/ 13.1lb	65	⊕
LED	DARK GREY	74349	DIE CAST ALU/OPAL POLYC	2 LED STRIP 96 LED 24W 2500 Lm 4000K INCL.	DRIVER INCL.	4.6Kg/ 10.1lb	65	⊕

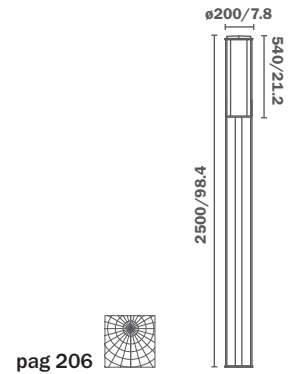

POLE LAMP	Finish	Reference	Material	Bulb	Gear	Weight	IP	Class
	DARK GREY	74370	DIE CAST ALU/OPAL POLYC	1xPL2G11 55W INCL.	EQ INCL.	19.2Kg/ 42.2lb	65	⊕

Optional antipollution light kit ref. 74370

CROSS ANTIPOLLUTION LIGHT KIT

Manel
LLuscà

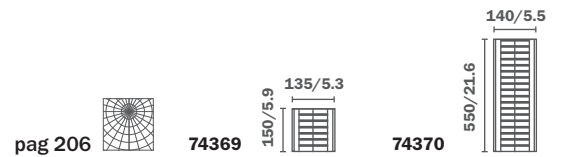
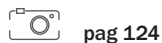

	Finish	Reference	Material	Bulb	Driver	Weight	IP	Class
	CHROME	74369	STEEL/TRANSP POLYC	-	-	0.8Kg/ 1.8lb	-	-
	CHROME	74370	STEEL/TRANSP POLYC	-	-	2.4Kg/ 5.3lb	-	-

dimensions in mm/inches respectively.
medidas en mm/pulgadas respectivamente.
dimensions en mm/pouces respectivement.

DATNA

OUT DOOR



pag 88

Manel
LLuscà

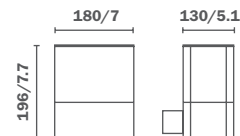

WALL LAMP	Finish	Reference	Material	Bulb	Gear	Weight	IP	Class
	DARK GREY	74440	DIE CAST ALU/OPAL POLYC	1xE27 MAX 20W NOT INCL. [16467]	-	1.5Kg/ 3.3lb	44	⊕



BEACON	Finish	Reference	Material	Bulb	Gear	Weight	IP	Class
	DARK GREY	74441	DIE CAST ALU/OPAL POLYC	1xE27 MAX 20W NOT INCL. [16467]	-	1.9Kg/ 4.2lb	44	⊕
	DARK GREY	74442	DIE CAST ALU/OPAL POLYC	1xE27 MAX 20W NOT INCL. [16467]	-	2.5Kg/ 5.5lb	44	⊕

DRAGMA

OUT DOOR



pag 152

Manel
LLuscà

pag 206



WALL LAMP	Finish	Reference	Material	Bulb	Gear	Weight	IP	Class
	DARK GREY	71362	DIE CAST AL/TRANSL GLASS	1xG24q-2 18W INCL.	MAGN. INCL.	1.69Kg/ 3.7lb	65	⊕

ETERFAN

IN DOOR



pag 10

Faro
Team

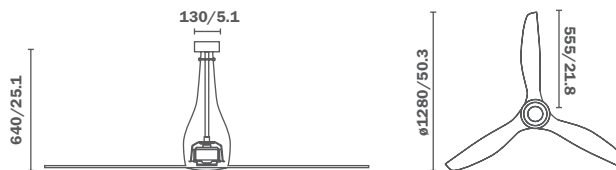

CEILING FAN	Finish	Reference	Material	W	RPM	Weight	IP	Class
	CHROME TRANSPARENT	33381	MET [BODY]/ TRANSP POLYC [BLADES]/ TRANSP GLASS [DIFFUSER]	3,5-5,8-8,8-13,4-21,5-32,4	51-77-103- 129-155- 185	9Kg/ 19.8lb	20	⊕

With **MOTOR DC** technology (noiseless, light weight, 6 speeds, energy saving, long life).

FARETTO

IN DOOR



pag 14

Faro Team

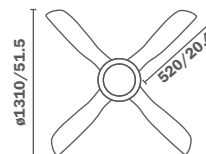
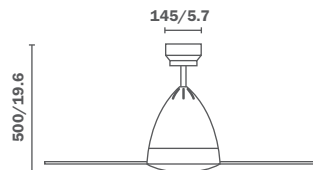

CEILING FAN	Finish	Reference	Material	Bulb	W	RPM	Weight	IP	Class
	WHITE TRANSPARENT	33389	MET [BODY]/ TRANSP POLYC [BLADES]/ TRANSP GLASS [DIFFUSER]	2xE27 MAX 15W NOT INCL. [16292]	18-33-53	60-90- 120	11.5Kg/ 25.3lb	20	⊕

Remote control included.
Mando a distancia incluido.
Télécommande incluse.

FLEXI

IN DOOR



pag 42

Manel LLuscà

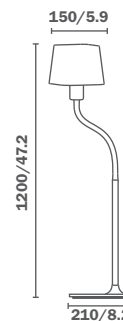

FLOOR LAMP	Finish	Reference	Material	Bulb	Gear	Weight	IP	Class
	WHITE	29924	POLYC/ACRY/STEEL	1xE27 MAX 15W NOT INCL. [16322]	-	4.9Kg/ 10.8lb	20	□
	BLACK	29925	POLYC/ACRY/STEEL	1xE27 MAX 15W NOT INCL. [16322]	-	4.9Kg/ 10.8lb	20	□
	MAGENTA	29926	POLYC/ACRY/STEEL	1xE27 MAX 15W NOT INCL. [16322]	-	4.9Kg/ 10.8lb	20	□
	GREEN	29927	POLYC/ACRY/STEEL	1xE27 MAX 15W NOT INCL. [16322]	-	4.9Kg/ 10.8lb	20	□

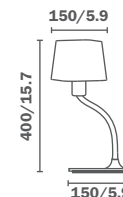
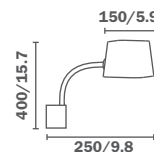

TABLE LAMP	Finish	Reference	Material	Bulb	Gear	Weight	IP	Class
	WHITE	29920	POLYC/ACRY/STEEL	1xE27 MAX 15W NOT INCL. [16322]	-	2.39Kg/ 5.3lb	20	□
	BLACK	29921	POLYC/ACRY/STEEL	1xE27 MAX 15W NOT INCL. [16322]	-	2.39Kg/ 5.3lb	20	□
	MAGENTA	29922	POLYC/ACRY/STEEL	1xE27 MAX 15W NOT INCL. [16322]	-	2.39Kg/ 5.3lb	20	□
	GREEN	29923	POLYC/ACRY/STEEL	1xE27 MAX 15W NOT INCL. [16322]	-	2.39Kg/ 5.3lb	20	□



WALL LAMP	Finish	Reference	Material	Bulb	Gear	Weight	IP	Class
	WHITE	29928	POLYC/ACRY/STEEL	1xE27 MAX 15W NOT INCL. [16322]	-	1.48Kg/ 3.3lb	20	□
	BLACK	29929	POLYC/ACRY/STEEL	1xE27 MAX 15W NOT INCL. [16322]	-	1.48Kg/ 3.3lb	20	□
	MAGENTA	29930	POLYC/ACRY/STEEL	1xE27 MAX 15W NOT INCL. [16322]	-	1.48Kg/ 3.3lb	20	□
	GREEN	29931	POLYC/ACRY/STEEL	1xE27 MAX 15W NOT INCL. [16322]	-	1.48Kg/ 3.3lb	20	□

dimensions in mm/inches respectively.
medidas en mm/pulgadas respectivamente.
dimensions en mm/pouces respectivement.

FOKUS

Faro Team

IN DOOR



pag 54

pag 206

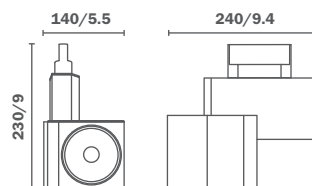

PROJECTOR	Finish	Reference	Material	Bulb	Gear	Weight	IP	Class
	WHITE	01041501	AL	1xQR111 LED MAX 15W NOT INCL.	ELT INCL.	1.7Kg/ 3.7lb	20	
	BLACK	01041502	AL	1xQR111 LED MAX 15W NOT INCL.	ELT INCL.	1.7Kg/ 3.7lb	20	
	WHITE ALUMINIUM	01041503	AL	1xQR111 LED MAX 15W NOT INCL.	ELT INCL.	1.7Kg/ 3.7lb	20	

Available for QR-CB51, QR-111, CDM-Tm, HIT-T, CDM-R111, QR-111 LED.

More info faropro.es

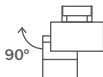

pag 206

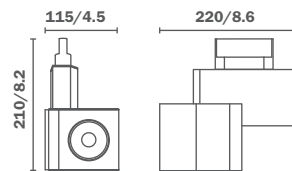

PROJECTOR	Finish	Reference	Material	Bulb	Gear	Weight	IP	Class
	WHITE	01040201	AL	1xGX5,3 MAX 12W NOT INCL.	ELT INCL.	1.1Kg/ 2.4lb	20	
	BLACK	01040202	AL	1xGX5,3 MAX 12W NOT INCL.	ELT INCL.	1.1Kg/ 2.4lb	20	
	WHITE ALUMINIUM	01040203	AL	1xGX5,3 MAX 12W NOT INCL.	ELT INCL.	1.1Kg/ 2.4lb	20	

Available for QR-CB51, QR-111, CDM-Tm, HIT-T, CDM-R111, QR-111 LED.

More info faropro.es

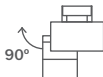

FUTURE

Estudi Ribaudi

OUT DOOR



pag 140

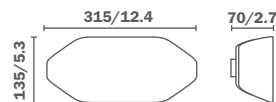
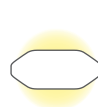

WALL LAMP	Finish	Reference	Material	Bulb	Gear	Weight	IP	Class
	WHITE	71516	POLYC	1xE27 MAX 20W NOT INCL. [16467]	-	1Kg/ 2.2lb	44	
	DARK GREY	71517	POLYC	1xE27 MAX 20W NOT INCL. [16467]	-	1Kg/ 2.2lb	44	

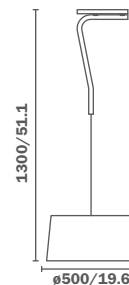

PENDANT LAMP	Finish	Reference	Material	Bulb	Gear	Weight	IP	Class
	WHITE	29944	MET/TEX	3xE27 MAX 20W NOT INCL. [16177]	-	1.3Kg/ 2.9lb	20	⊕
	BLACK	29949	MET/TEX	3xE27 MAX 20W NOT INCL. [16177]	-	1.3Kg/ 2.9lb	20	⊕

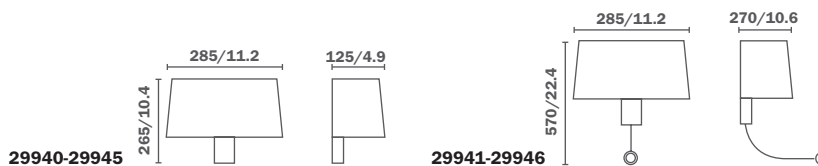

WALL LAMP	Finish	Reference	Material	Bulb	Gear	Weight	IP	Class
	WHITE	29940	MET/TEX	1xE27 MAX 15W NOT INCL. [16292]	-	1.2Kg/ 2.6lb	20	⊕
	BLACK	29945	MET/TEX	1xE27 MAX 15W NOT INCL. [16292]	-	1.2Kg/ 2.6lb	20	⊕
	WHITE	29941	MET/TEX	1xE27 MAX 15W NOT INCL [16292] + LED 1W INCL.	INCL.	1.4Kg/ 3.1lb	20	⊕
	BLACK	29946	MET/TEX	1xE27 MAX 15W NOT INCL.[16292] + LED 1W INCL.	INCL.	1.4Kg/ 3.1lb	20	⊕

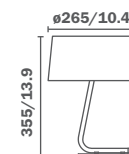
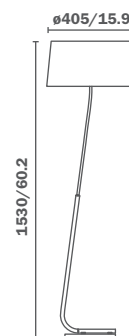

TABLE LAMP	Finish	Reference	Material	Bulb	Gear	Weight	IP	Class
	WHITE	29942	MET/TEX	1xE27 MAX 20W NOT INCL. [16292]	-	1.8Kg/ 4lb	20	□
	BLACK	29947	MET/TEX	1xE27 MAX 20W NOT INCL. [16292]	-	1.8Kg/ 4lb	20	□



FLOOR LAMP	Finish	Reference	Material	Bulb	Driver	Weight	IP	Class
	WHITE	29943	MET/TEX	1xE27 MAX 20W NOT INCL. [16177]	-	2.3Kg/ 5.1lb	20	□
	BLACK	29948	MET/TEX	1xE27 MAX 20W NOT INCL. [16177]	-	2.3Kg/ 5.1lb	20	□

KLAMP

OUT
DOOR



pag 100

Manel
LLuscà

pag 206

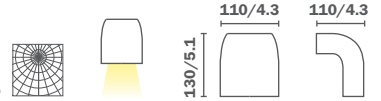

WALL LAMP	Finish	Reference	Material	Bulb	Gear	Weight	IP	Class
	DARK GREY	74407	DIE CAST AL/TRANSP GLASS	1xGU10 MAX 35W NOT INCL. [14141]	-	0.65Kg/ 1.4lb	44	⊕

pag 206

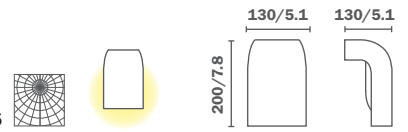

WALL LAMP	Finish	Reference	Material	Bulb	Gear	Weight	IP	Class
	DARK GREY	74409	DIE CAST AL/OPAL POLYC	1xE27 MAX 15W NOT INCL. [16466]	-	1.1Kg/ 2.4lb	44	⊕

pag 206

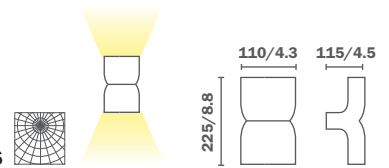

WALL LAMP	Finish	Reference	Material	Bulb	Gear	Weight	IP	Class
	DARK GREY	74408	DIE CAST AL/TRANSP GLASS	2xGU10 MAX 35W NOT INCL. [14141]	-	0.97Kg/ 2.1lb	44	⊕

pag 207



74410-74412

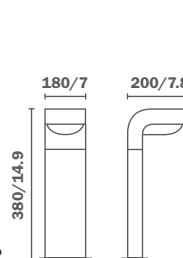

74411-74413

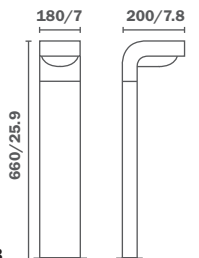

BEACON	Finish	Reference	Material	Bulb	Gear	Weight	IP	Class
	DARK GREY	74410	DIE CAST AL/OPAL POLYC	1xE27 MAX 15W NOT INCL. [16466]	-	2.1Kg/ 4.6lb	44	⊕
	DARK GREY	74411	DIE CAST AL/OPAL POLYC	1xE27 MAX 15W NOT INCL. [16466]	-	2.84Kg/ 6.2lb	44	⊕
NIGHT & DAY SENSOR	DARK GREY	74412	DIE CAST AL/OPAL POLYC	1xE27 MAX 15W NOT INCL. [16466] 1 LED 1W INCL.	-	2.2Kg/ 4.8lb	44	⊕
NIGHT & DAY SENSOR	DARK GREY	74413	DIE CAST AL/OPAL POLYC	1xE27 MAX 15W NOT INCL. [16466] 1 LED 1W INCL.	-	3.1Kg/ 6.8lb	44	⊕

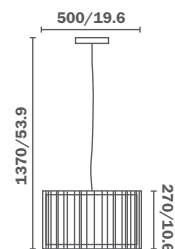

PENDANT LAMP	Finish	Reference	Material	Bulb	Gear	Weight	IP	Class
	BLACK	29313	STEEL/TEX	1xE27 100W NOT INCL. [16212]	-	4.4Kg/ 9.7lb	20	⊕
	WHITE	29309	STEEL/TEX	1xE27 100W NOT INCL. [16212]	-	4.4Kg/ 9.7lb	20	⊕

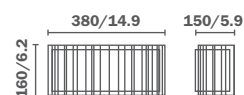

WALL LAMP	Finish	Reference	Material	Bulb	Gear	Weight	IP	Class
	BLACK	29310	STEEL/TEX	2xE27 15W NOT INCL. [16166]	-	1.39Kg/ 3.1lb	20	⊕
	WHITE	29306	STEEL/TEX	2xE27 15W NOT INCL. [16166]	-	1.39Kg/ 3.1lb	20	⊕

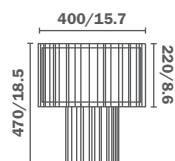
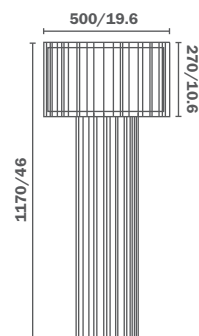

TABLE LAMP	Finish	Reference	Material	Bulb	Gear	Weight	IP	Class
	BLACK	29311	STEEL/TEX	1xE27 100W NOT INCL. [16212]	-	3.5Kg/ 7.7lb	20	□
	WHITE	29307	STEEL/TEX	1xE27 100W NOT INCL. [16212]	-	3.5Kg/ 7.7lb	20	□



FLOOR LAMP	Finish	Reference	Material	Bulb	Gear	Weight	IP	Class
	BLACK	29312	STEEL/TEX	1xE27 100W NOT INCL. [16212]	-	6.5Kg/ 14.3lb	20	□
	WHITE	29308	STEEL/TEX	1xE27 100W NOT INCL. [16212]	-	6.5Kg/ 14.3lb	20	□



29877-29878

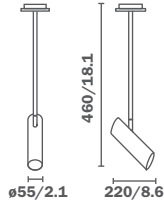

29879-29880

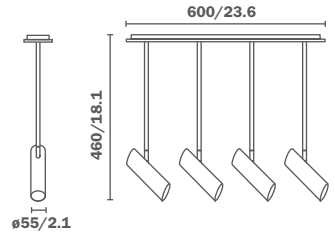

PENDANT LAMP	Finish	Reference	Material	Bulb	Gear	Weight	IP	Class
	WHITE	29877	STEEL	1xGU10 11W NOT INCL. [14140]	-	0.8Kg/ 1.8lb	20	⊕
	BLACK	29878	STEEL	1xGU10 11W NOT INCL. [14140]	-	0.8Kg/ 1.8lb	20	⊕
	WHITE	29879	STEEL	4xGU10 11W NOT INCL. [14140]	-	3.3Kg/ 7.3lb	20	⊕
	BLACK	29880	STEEL	4xGU10 11W NOT INCL. [14140]	-	3.3Kg/ 7.3lb	20	⊕

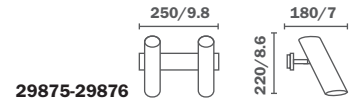

WALL LAMP	Finish	Reference	Material	Bulb	Gear	Weight	IP	Class
	WHITE	29873	STEEL	1xGU10 11W NOT INCL. [14140]	-	0.6Kg/ 1.3lb	20	⊕
	BLACK	29874	STEEL	1xGU10 11W NOT INCL. [14140]	-	0.6Kg/ 1.3lb	20	⊕
	WHITE	29875	STEEL	2xGU10 11W NOT INCL. [14140]	-	1.2Kg/ 2.6lb	20	⊕
	BLACK	29876	STEEL	2xGU10 11W NOT INCL. [14140]	-	1.2Kg/ 2.6lb	20	⊕

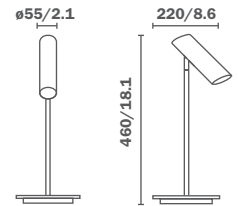
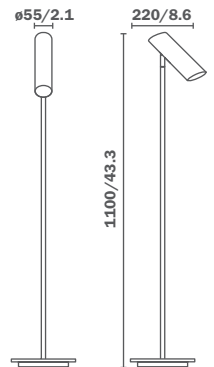
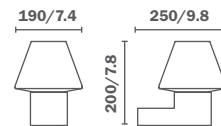

TABLE LAMP	Finish	Reference	Material	Bulb	Gear	Weight	IP	Class
	WHITE	29881	STEEL	1xGU10 11W NOT INCL. [14140]	-	1.77Kg/ 3.9 lb	20	□
	BLACK	29882	STEEL	1xGU10 11W NOT INCL. [14140]	-	1.77Kg/ 3.9 lb	20	□



FLOOR LAMP	Finish	Reference	Material	Bulb	Gear	Weight	IP	Class
	WHITE	29883	STEEL	1xGU10 11W NOT INCL. [14140]	-	3.1Kg/ 6.8lb	20	□
	BLACK	29884	STEEL	1xGU10 11W NOT INCL. [14140]	-	3.1Kg/ 6.8lb	20	□



WALL LAMP	Finish	Reference	Material	Bulb	Gear	Weight	IP	Class
	DARK GREY WHITE	74432+ 74428	OPAL PMMA/DIE CAST AL	1xE27 MAX 20W NOT INCL. [16467]	-	0.8Kg/ 1.8lb	44	⊕

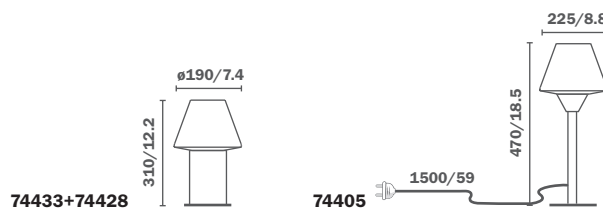

POST LAMP	Finish	Reference	Material	Bulb	Gear	Weight	IP	Class
	DARK GREY WHITE	74433+ 74428	OPAL PMMA/DIE CAST AL	1xE27 MAX 20W NOT INCL. [16467]	-	2Kg/ 4.4lb	44	⊕

TABLE LAMP	Finish	Reference	Material	Bulb	Gear	Weight	IP	Class
	DARK GREY WHITE	74405	OPAL PMMA/DIE CAST AL	1xE27 MAX 20W NOT INCL. [16467]	-	1.5Kg/ 3.3lb	44	□

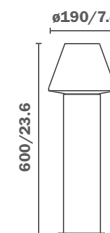

BEACON	Finish	Reference	Material	Bulb	Gear	Weight	IP	Class
	DARK GREY WHITE	74434+ 74428	OPAL PMMA/DIE CAST AL	1xE27 MAX 20W NOT INCL. [16467]	-	2.7Kg/ 5.9lb	44	⊕

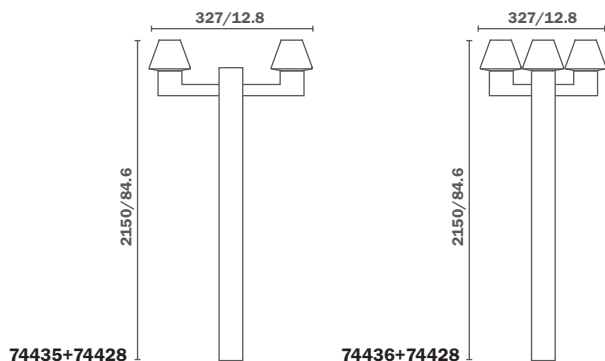

POLE LAMP	Finish	Reference	Material	Bulb	Gear	Weight	IP	Class
	DARK GREY WHITE	74435+ 74428 (2 units)	OPAL PMMA/DIE CAST AL	2xE27 MAX 20W NOT INCL. [16467]	-	8.5Kg/ 18.7lb	44	⊕
	DARK GREY WHITE	74436+ 74428 (3 units)	OPAL PMMA/DIE CAST AL	3xE27 MAX 20W NOT INCL. [16467]	-	10.3Kg/ 22.7 lb	44	⊕

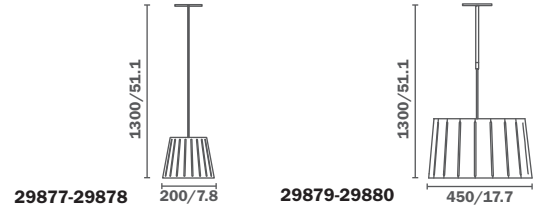

PENDANT LAMP	Finish	Reference	Material	Bulb	Gear	Weight	IP	Class
	WHITE	29966	MET	1xE14 MAX 60W NOT INCL. [16269]	-	1Kg/ 2.2lb	20	⊕
	BLACK	29967	MET	1xE14 MAX 60W NOT INCL. [16269]	-	1Kg/ 2.2lb	20	⊕
	WHITE	29968	WOOD/MET	2xE27 MAX 60W NOT INCL. [16212]	-	3.5Kg/ 7.7lb	20	⊕
	BLACK	29969	WOOD/MET	2xE27 MAX 60W NOT INCL. [16212]	-	3.5Kg/ 7.7lb	20	⊕

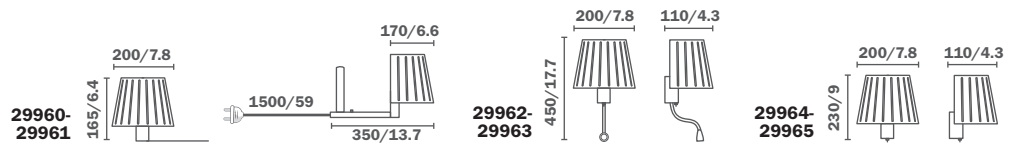

WALL LAMP	Finish	Reference	Material	Bulb	Gear	Weight	IP	Class
FOR SHELFs	WHITE	29960	MET	1xE14 MAX 14W NOT INCL. [16269]	-	0.8Kg/ 1.8lb	20	□
FOR SHELFs	BLACK	29961	MET	1xE14 MAX 14W NOT INCL. [16269]	-	0.8Kg/ 1.8lb	20	□
WITH READER	WHITE	29962	MET	1xE27 MAX 60W NOT INCL. [16219] 1 LED 3W INCL.	-	0.85Kg/ 1.9lb	20	□
WITH READER	BLACK	29963	MET	1xE27 MAX 60W NOT INCL. [16219] 1 LED 3W INCL.	-	0.85Kg/ 1.9lb	20	□
	WHITE	29964	MET	1xE14 MAX 60W NOT INCL. [16269]	-	1.1Kg/ 2.4lb	20	□
	BLACK	29965	MET	1xE14 MAX 60W NOT INCL. [16269]	-	1.1Kg/ 2.4lb	20	□

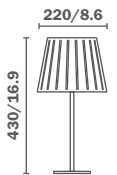
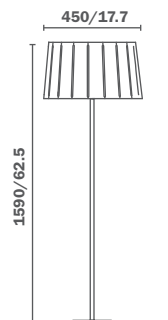
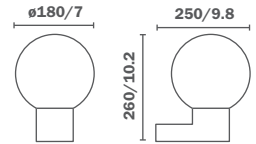

TABLE LAMP	Finish	Reference	Material	Bulb	Gear	Weight	IP	Class
	WHITE	29970	WOOD/MET	1xE14 MAX 60W NOT INCL. [16269]	-	3.15Kg/ 6.9lb	20	□
	BLACK	29971	WOOD/MET	1xE14 MAX 60W NOT INCL. [16269]	-	3.15Kg/ 6.9lb	20	□



FLOOR LAMP	Finish	Reference	Material	Bulb	Gear	Weight	IP	Class
	WHITE	29972	WOOD/METAL	1xE27 MAX 60W NOT INCL. [16212]	-	9.5Kg/ 20.9lb	20	□
	BLACK	29973	WOOD/METAL	1xE27 MAX 60W NOT INCL. [16212]	-	9.5Kg/ 20.9lb	20	□



WALL LAMP	Finish	Reference	Material	Bulb	Gear	Weight	IP	Class
	DARK GREY WHITE	74432+ 74437	OPAL PMMA/ DIE CAST AL	1xE27 MAX 20W NOT INCL. [16467]	-	1.2Kg/ 2.6lb	44	⊕

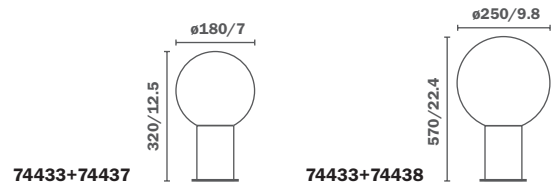

POST LAMP	Finish	Reference	Material	Bulb	Gear	Weight	IP	Class
	DARK GREY WHITE	74433+ 74437	OPAL PMMA/ DIE CAST AL	1xE27 MAX 20W NOT INCL. [16467]	-	1.8Kg/ 4lb	44	⊕
	DARK GREY WHITE	74433+ 74438	OPAL PMMA/ DIE CAST AL	1xE27 MAX 20W NOT INCL. [16467]	-	2Kg/ 4.4lb	44	⊕

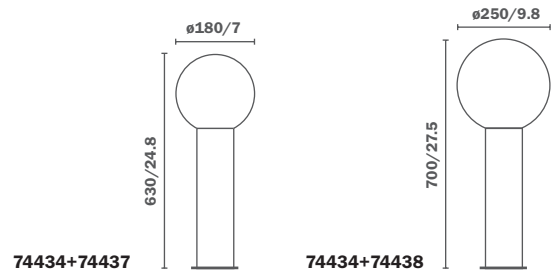

BEACON	Finish	Reference	Material	Bulb	Gear	Weight	IP	Class
	DARK GREY WHITE	74434+ 74437	OPAL PMMA/ DIE CAST AL	1xE27 MAX 20W NOT INCL. [16467]	-	2.8Kg/ 6.2lb	44	⊕
	DARK GREY WHITE	74434+ 74438	OPAL PMMA/ DIE CAST AL	1xE27 MAX 20W NOT INCL. [16467]	-	3Kg/ 6.6lb	44	⊕

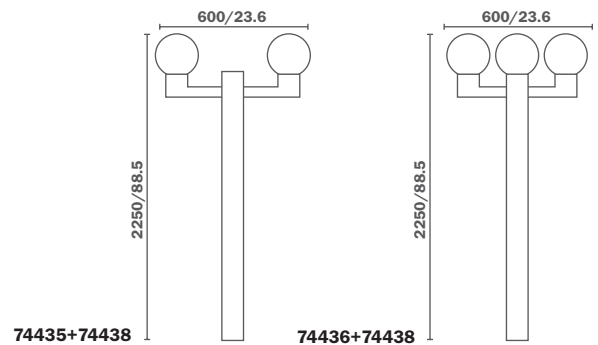

POLE LAMP	Finish	Reference	Material	Bulb	Gear	Weight	IP	Class
	DARK GREY WHITE	74435+ 74438 (2 units)	OPAL PMMA/ DIE CAST AL	2xE27 MAX 20W NOT INCL. [16467]	-	8.42Kg/ 18.5lb	44	⊕
	DARK GREY WHITE	74436+ 74438 (3 units)	OPAL PMMA/ DIE CAST AL	3xE27 MAX 20W NOT INCL. [16467]	-	10.2Kg/ 22.4lb	44	⊕

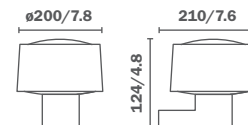

WALL LAMP	Finish	Reference	Material	Bulb	Gear	Weight	IP	Class
	DARK GREY WHITE	74432+ 74429	OPAL PMMA/DIE CAST AL	1xE27 MAX 20W NOT INCL. [16467]	-	1.2Kg/ 2.6lb	44	⊕

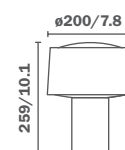

POST LAMP	Finish	Reference	Material	Bulb	Gear	Weight	IP	Class
	DARK GREY WHITE	74433+ 74429	OPAL PMMA/DIE CAST AL	1xE27 MAX 20W NOT INCL. [16467]	-	2.2Kg/ 4.8lb	44	⊕

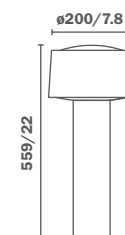

BEACON	Finish	Reference	Material	Bulb	Gear	Weight	IP	Class
	DARK GREY WHITE	74434+ 74429	OPAL PMMA/DIE CAST AL	1xE27 MAX 20W NOT INCL. [16467]	-	3.5Kg/ 7.7lb	44	⊕

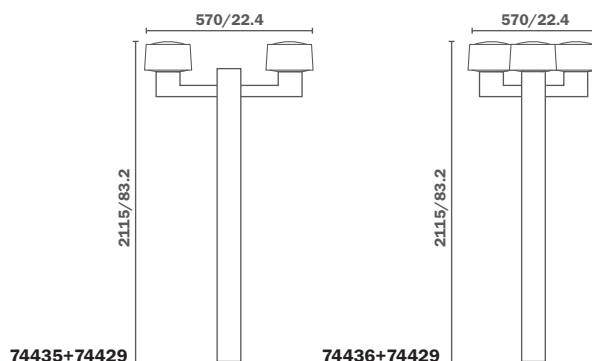

POLE LAMP	Finish	Reference	Material	Bulb	Gear	Weight	IP	Class
	DARK GREY WHITE	74435+ 74429 (2 units)	OPAL PMMA/ DIE CAST AL	2xE27 MAX 20W NOT INCL. [16467]	-	8.9Kg/ 19.6lb	44	⊕
	DARK GREY WHITE	74436+ 74429 (3 units)	OPAL PMMA/ DIE CAST AL	3xE27 MAX 20W NOT INCL. [16467]	-	10.9Kg/ 24lb	44	⊕

NEWPORT

OUT DOOR



pag 104

Estudi Ribaudí

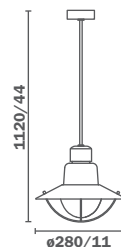

PENDANT LAMP	Finish	Reference	Material	Bulb	Gear	Weight	IP	Class
	WHITE	71154	MET/OPAL GLASS	1xE27 MAX 60W NOT INCL. [16466]	-	1.67Kg/ 3.7lb	33	⊕
	MOSS GREEN	71155	MET/OPAL GLASS	1xE27 MAX 60W NOT INCL. [16466]	-	1.67Kg/ 3.7lb	33	⊕
	BORDEAUX	71156	MET/OPAL GLASS	1xE27 MAX 60W NOT INCL. [16466]	-	1.67Kg/ 3.7lb	33	⊕

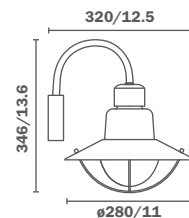

WALL LAMP	Finish	Reference	Material	Bulb	Gear	Weight	IP	Class
	WHITE	71151	MET/OPAL GLASS	1xE27 MAX 60W NOT INCL. [16466]	-	1.7Kg/ 3.7lb	44	⊕
	MOSS GREEN	71152	MET/OPAL GLASS	1xE27 MAX 60W NOT INCL. [16466]	-	1.7Kg/ 3.7lb	44	⊕
	BORDEAUX	71153	MET/OPAL GLASS	1xE27 MAX 60W NOT INCL. [16466]	-	1.7Kg/ 3.7lb	44	⊕

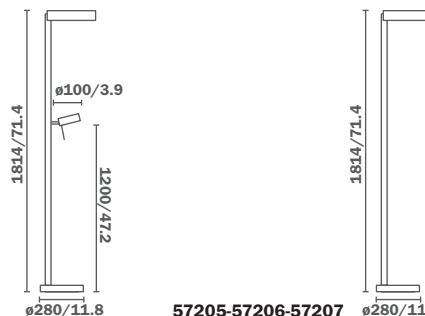

NEXO

IN DOOR



pag 50

Estudi Ribaudí

FLOOR LAMP	Finish	Reference	Material	Bulb	Gear	Weight	IP	Class
	MATT NIKEL	57200	MET/TRANSL GLASS	2xE27 MAX 15W NOT INCL. [16292]	-	7.2Kg/ 15.8lb	20	□
	WHITE	57201	MET/TRANSL GLASS	2xE27 MAX 15W NOT INCL. [16292]	-	7.2Kg/ 15.8lb	20	□
	BLACK	57202	MET/TRANSL GLASS	2xE27 MAX 15W NOT INCL. [16292]	-	7.2Kg/ 15.8lb	20	□
WITH READER	MATT NIKEL	57205	MET/TRANSL GLASS	2xE27 MAX 15W NOT INCL. [16292] + 1xG9 28W INCL.	-	7.2Kg/ 15.8lb	20	□
WITH READER	WHITE	57206	MET/TRANSL GLASS	2xE27 MAX 15W NOT INCL. [16292] + 1xG9 28W INCL.	-	7.2Kg/ 15.8lb	20	□
WITH READER	BLACK	57207	MET/TRANSL GLASS	2xE27 15W NOT INCL. [16292] + 1xG9 28W INCL.	-	7.2Kg/ 15.8lb	20	□

NUK

OUT DOOR



pag 172

Manel Llusçà

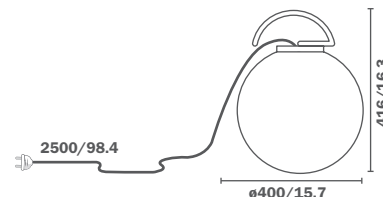

PORTABLE	Finish	Reference	Material	Bulb	Gear	Weight	IP	Class
	ORANGE	70484	PMMA	1xE27 MAX 60W NOT INCL.[16467]	-	0.6Kg/ 1.3lb	44	□
	MAY GREEN	70485	PMMA	1xE27 MAX 60W NOT INCL.[16467]	-	0.6Kg/ 1.3lb	44	□
	GRAPHITE	70486	PMMA	1xE27 MAX 60W NOT INCL.[16467]	-	0.6Kg/ 1.3lb	44	□
	MAGENTA	70487	PMMA	1xE27 MAX 60W NOT INCL.[16467]	-	0.6Kg/ 1.3lb	44	□

dimensions in mm/inches respectively.
medidas en mm/pulgadas respectivamente.
dimensions en mm/pouces respectivement.

PÉRGAMO

Faro
Team

IN
DOOR



pag 70

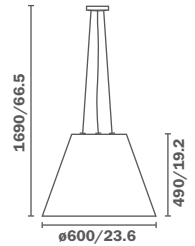

PENDANT LAMP	Finish	Reference	Material	Bulb	Gear	Weight	IP	Class
	BEIGE BLACK	29300	STEEL/PARCH/ACRYL	3xE27 MAX 60W NOT INCL.[16167]	-	1.33Kg/ 2.9lb	20	⊕

PROA

Manel
LLuscà

OUT
DOOR



pag 144

pag 207

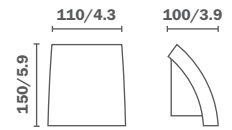

WALL LAMP	Finish	Reference	Material	Bulb	Gear	Weight	IP	Class
LED	DARK GREY	74399	DIE CAST AL/TRANSP GLASS	1xGU10 LED 5W NOT INCL.[14141]	DRIVER INCL.	0.65Kg/ 1.4lb	44	⊕
	DARK GREY	74400	DIE CAST AL/TRANSP GLASS	1xGU10 MAX 35W NOT INCL. [14141]	-	0.65Kg/ 1.4lb	44	⊕

PROJECT

Manel
LLuscà

OUT
DOOR



pag 164

pag 207



71383
71390

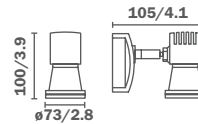

71382
71389

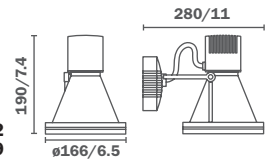

PROJECTOR	Finish	Reference	Material	Bulb	Gear	Weight	IP	Class
	GREY ALUMINIUM	71383	DIE CAST AL/TRANSP GLASS	1xGU10 MAX 50W NOT INCL.[14141]	-	0.58Kg/ 1.3lb	65	⊕
	DARK GREY	71390	DIE CAST AL/TRANSP GLASS	1xGU10 MAX 50W NOT INCL. [14141]	-	0.58Kg/ 1.3lb	65	⊕
	GREY ALUMINIUM	71382	DIE CAST AL/TRANSP GLASS	1xE27 PAR 38 MAX 20W NOT INCL. [14149]	-	1.6Kg/ 3.5lb	65	⊕
	DARK GREY	71389	DIE CAST AL/TRANSP GLASS	1xE27 PAR 38 MAX 20W NOT INCL. [14149]	-	1.6Kg/ 3.5lb	65	⊕

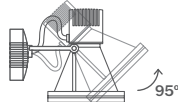
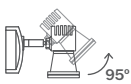

RATTAN

Manel
LLuscà

OUT
DOOR



pag 160

71203

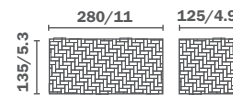

71204

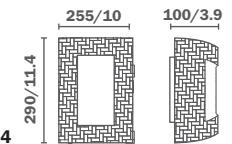

WALL LAMP	Finish	Reference	Material	Bulb	Gear	Weight	IP	Class
	DARK BROWN	71203	STEEL/RATTAN/OPAL POLYC	1xE27 MAX 20W NOT INCL. [16167]	-	1.7Kg/ 3.7lb	44	⊕
	DARK BROWN	71204	STEEL/RATTAN/OPAL POLYC	1xE27 MAX 20W NOT INCL. [16167]	-	1.47Kg/ 3.2lb	44	⊕

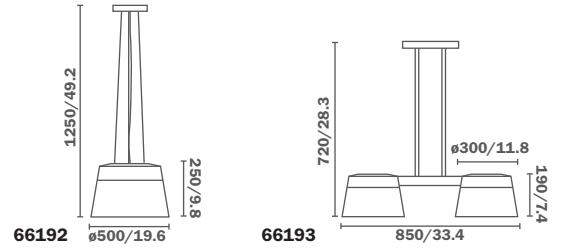

PENDANT LAMP	Finish	Reference	Material	Bulb	Gear	Weight	IP	Class
	CREAM DARK BROWN	66192	MET/TEX/POLYC	3xE27 MAX 60W NOT INCL.[16167]	-	5.15Kg/ 11.3lb	20	⊕
	CREAM DARK BROWN	66193	MET/TEX	2xE27 MAX 60W NOT INCL. [16167]	-	4.3Kg/ 9.5lb	20	⊕

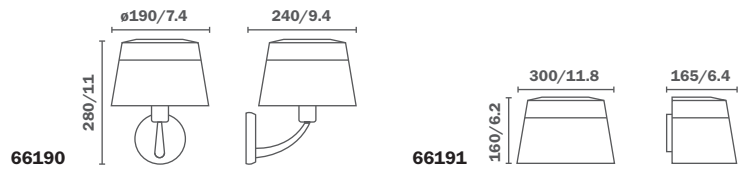

WALL LAMP	Finish	Reference	Material	Bulb	Gear	Weight	IP	Class
	CREAM DARK BROWN	66190	MET/TEX	1xE27 MAX 60W NOT INCL. [16466]	-	1.13Kg/ 2.5lb	20	⊕
	CREAM DARK BROWN	66191	MET/TEX	2xE14 MAX 60W NOT INCL.[16291]	-	0.8Kg/ 1.8lb	20	⊕

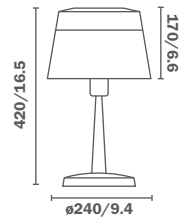

TABLE LAMP	Finish	Reference	Material	Bulb	Gear	Weight	IP	Class
	CREAM DARK BROWN	66194	MET/TEX	1xE27 MAX 60W NOT INCL.[16292]	-	2Kg/ 4.4lb	20	□



FLOOR LAMP	Finish	Reference	Material	Bulb	Gear	Weight	IP	Class
	CREAM DARK BROWN	66195	MET/TEX	2xE27 MAX 60W NOT INCL. [16167]	-	8.61Kg/ 18.9lb	20	□

SENTINEL

Estudi Ribaudí

OUT DOOR



pag 96

pag 207

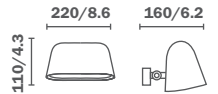

WALL LAMP	Finish	Reference	Material	Bulb	Gear	Weight	IP	Class
LED	DARK GREY	75099	DIE CAST AL/TRANSP GLASS	40 LED 8W 735 Lm 4000K INCL.	DRIVER INCL.	0.86Kg/ 1.9lb	44	⊕
	WHITE	75100	DIE CAST AL/TRANSP GLASS	1xE27 MAX 20W NOT INCL. [16467]	-	0.86Kg/ 1.9lb	44	⊕
	DARK GREY	75101	DIE CAST AL/TRANSP GLASS	1xE27 MAX 20W NOT INCL. [16467]	-	0.86Kg/ 1.9lb	44	⊕

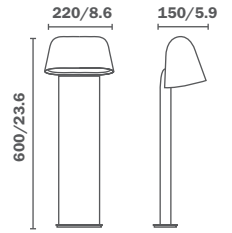

BEACON	Finish	Reference	Material	Bulb	Gear	Weight	IP	Class
	WHITE	75102	DIE CAST AL/TRANSP GLASS	1xE27 MAX 20W NOT INCL. [16467]	-	2.64Kg/ 5.8lb	44	⊕
	DARK GREY	75103	DIE CAST AL/TRANSP GLASS	1xE27 MAX 20W NOT INCL. [16467]	-	2.64Kg/ 5.8lb	44	⊕

STEPS

Estudi Ribaudí

OUT DOOR



pag 84

with caps



without caps



75500-75501

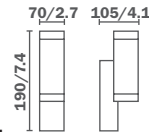

75502-75503

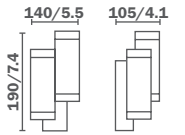

WALL LAMP	Finish	Reference	Material	Bulb	Gear	Weight	IP	Class
	WHITE	75500	DIE CAST AL/TEMP GLASS	2xGU10 MAX 35W NOT INCL. [14141]	-	0.94Kg/ 2.1lb	44	⊕
	DARK GREY	75501	DIE CAST AL/TEMP GLASS	2xGU10 MAX 35W NOT INCL. [14141]	-	0.94Kg/ 2.1lb	44	⊕
	WHITE	75502	DIE CAST AL/TEMP GLASS	4xGU10 MAX 35W NOT INCL. [14141]	-	1.5Kg/ 3.3lb	44	⊕
	DARK GREY	75503	DIE CAST AL/TEMP GLASS	4xGU10 MAX 35W NOT INCL. [14141]	-	1.5Kg/ 3.3lb	44	⊕

Dark grey or white cap/s included.

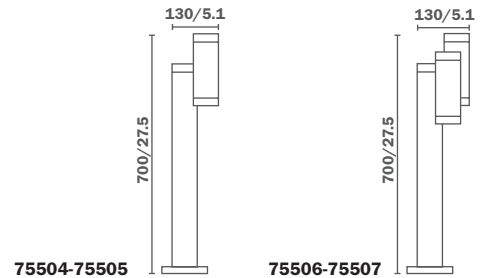

75504-75505

75506-75507

BEACON	Finish	Reference	Material	Bulb	Gear	Weight	IP	Class
	WHITE	75504	DIE CAST AL/TEMP GLASS	1xGU10 MAX 35W NOT INCL. [14141]	-	2.75Kg/ 6.1lb	44	⊕
	DARK GREY	75505	DIE CAST AL/TEMP GLASS	1xGU10 MAX 35W NOT INCL. [14141]	-	2.75Kg/ 6.1lb	44	⊕
	WHITE	75506	DIE CAST AL/TEMP GLASS	2xGU10 MAX 35W NOT INCL. [14141]	-	3Kg/ 6.6lb	44	⊕
	DARK GREY	75507	DIE CAST AL/TEMP GLASS	2xGU10 MAX 35W NOT INCL. [14141]	-	3Kg/ 6.6lb	44	⊕

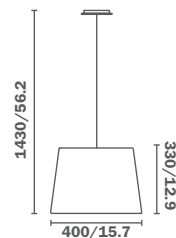

PENDANT LAMP	Finish	Reference	Material	Bulb	Gear	Weight	IP	Class
	WHITE	29956	MET/TEX	1xE27 MAX 20W NOT INCL. [16218]	-	1.7Kg/ 3.7lb	20	⊕
	BLACK	29957	MET/TEX	1xE27 MAX 20W NOT INCL. [16218]	-	1.7Kg/ 3.7lb	20	⊕

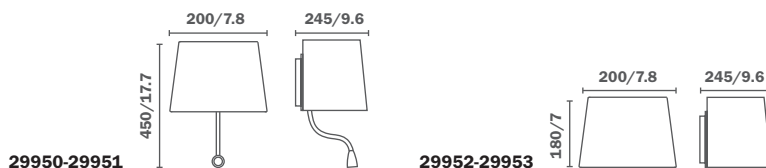

WALL LAMP	Finish	Reference	Material	Bulb	Gear	Weight	IP	Class
WITH READER	WHITE	29950	MET/TEX	1xE27 MAX 15W NOT INCL. [16292] + 1LED 1W INCL.	DRIVER INCL.	1.2Kg/ 2.6lb	20	⊕
WITH READER	BLACK	29951	MET/TEX	1xE27 MAX 15W NOT INCL. [16292] + 1LED 1W INCL.	DRIVER INCL.	1.2Kg/ 2.6lb	20	⊕
	WHITE	29952	MET/TEX	1xE27 MAX 15W NOT INCL. [16292]	-	1.2Kg/ 2.6lb	20	⊕
	BLACK	29953	MET/TEX	1xE27 MAX 15W NOT INCL. [16292]	-	1.2Kg/ 2.6lb	20	⊕

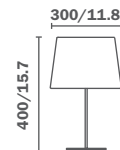

TABLE LAMP	Finish	Reference	Material	Bulb	Gear	Weight	IP	Class
	WHITE	29954	MET/TEX	1xE27 MAX 20W NOT INCL. [16293]	-	1.4Kg/ 3.1lb	20	□
	BLACK	29955	MET/TEX	1xE27 MAX 20W NOT INCL. [16293]	-	1.4Kg/ 3.1lb	20	□



FLOOR LAMP	Finish	Reference	Material	Bulb	Gear	Weight	IP	Class
	WHITE	29958	MET/TEX	1xE27 MAX 20W NOT INCL. [16177]	-	1.9Kg/ 4.2lb	20	□
	BLACK	29959	MET/TEX	1xE27 MAX 20W NOT INCL. [16177]	-	1.9Kg/ 4.2lb	20	□

TREE

IN DOOR



pag 38

Estudi
Ribaudí

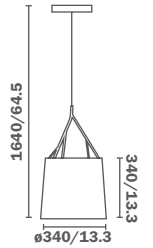

PENDANT LAMP	Finish	Reference	Material	Bulb	Gear	Weight	IP	Class
	BLACK	29864	MET/TEX	1xE27 MAX 100W NOT INCL. [16212]	-	3Kg/ 6.6lb	20	⊕
	WHITE	29865	MET/TEX	1xE27 MAX 100W NOT INCL. [16212]	-	3Kg/ 6.6lb	20	⊕

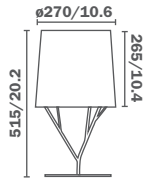
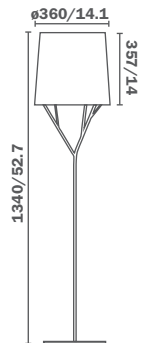

TABLE LAMP	Finish	Reference	Material	Bulb	Gear	Weight	IP	Class
	BLACK	29866	MET/TEX	1xE27 MAX 60W NOT INCL. [16212]	-	3.9Kg/ 8.6lb	20	□
	WHITE	29867	MET/TEX	1xE27 MAX 60W NOT INCL. [16212]	-	3.9Kg/ 8.6lb	20	□



FLOOR LAMP	Finish	Reference	Material	Bulb	Gear	Weight	IP	Class
	BLACK	29868	MET/TEX	1xE27 MAX 60W NOT INCL. [16212]	-	8.2Kg/ 18lb	20	□
	WHITE	29869	MET/TEX	1xE27 MAX 60W NOT INCL. [16212]	-	8.2Kg/ 18lb	20	□

TRIAL

OUT
DOOR



pag 132

Manel
LLuscà

pag 207



74380

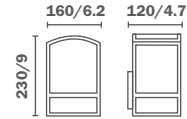

74381

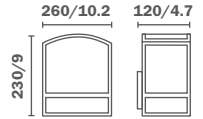

WALL LAMP	Finish	Reference	Material	Bulb	Gear	Weight	IP	Class
	DARK GREY	74380	MET/OPAL POLYC	1xE27 MAX 20W INCL.	-	1.2Kg/ 2.6lb	44	
	DARK GREY	74381	MET/OPAL POLYC	2xE27 MAX 20W INCL.	-	1.2Kg/ 2.6lb	44	

pag 207

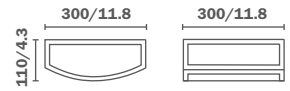

CEILING LAMP	Finish	Reference	Material	Bulb	Gear	Weight	IP	Class
	DARK GREY	74386	MET/OPAL POLYC	2xE27 MAX 20W INCL.	-	2.37Kg/ 5.2lb	44	

pag 207

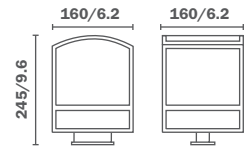

POST LAMP	Finish	Reference	Material	Bulb	Gear	Weight	IP	Class
	DARK GREY	74382	MET/OPAL POLYC	1xE27 MAX 20W INCL.	-	3.4Kg/ 7.5lb	44	

pag 207



74384

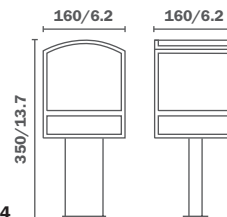

74385

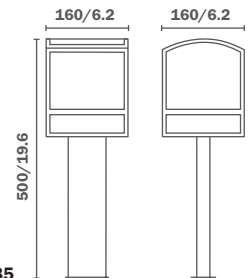

BEACON	Finish	Reference	Material	Bulb	Gear	Weight	IP	Class
	DARK GREY	74384	MET/OPAL POLYC	1xE27 MAX 20W INCL.	-	2.7Kg/ 5.9lb	44	
	DARK GREY	74385	MET/OPAL POLYC	1xE27 MAX 20W INCL.	-	2.7Kg/ 5.9lb	44	

dimensions in mm/inches respectively.
medidas en mm/pulgadas respectivamente.
dimensions en mm/pouces respectivement.

TWIN

IN DOOR



pag 66

Manel
LLuscà

66183-66184

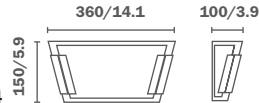

66185-66186

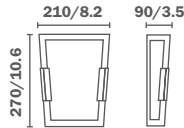

66187-66188

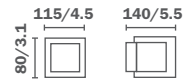

WALL LAMP	Finish	Reference	Material	Bulb	Weight	IP	Class
	MATT NIKEL	66183	MET/TRANSL GLASS	2xE27 MAX 60W NOT INCL. [16292]	1.8Kg/4lb	20	⊕
	RUST	66184	MET/TRANSL GLASS	2xE27 MAX 60W NOT INCL. [16292]	1.8Kg/4lb	20	⊕
	MATT NIKEL	66185	MET/TRANSL GLASS	2xE14 MAX 60W NOT INCL. [16291]	1.8Kg/4lb	20	⊕
	RUST	66186	MET/TRANSL GLASS	2xE14 MAX 60W NOT INCL. [16291]	1.8Kg/4lb	20	⊕
	MATT NIKEL	66187	MET/TRANSL GLASS	1xG9 MAX 50W NOT INCL. [15616]	1.58Kg/3.5lb	20	⊕
	RUST	66188	MET/TRANSL GLASS	1xG9 MAX 50W NOT INCL. [15616]	1.58Kg/3.5lb	20	⊕

VERSUS

IN DOOR



pag 46

Pepe
Llaudet

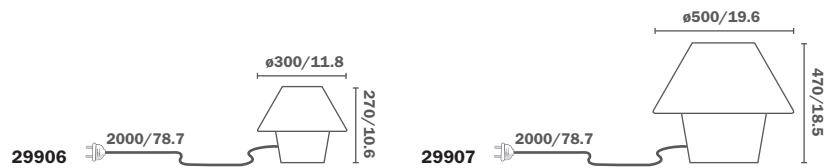

TABLE LAMP	Finish	Reference	Material	Bulb	Gear	Weight	IP	Class
	WHITE	29906	TEX	1xE27 MAX 60W NOT INCL. [16166]	-	1.5Kg/3.3lb	20	⊕
	WHITE	29907	TEX	1xE27 MAX 60W NOT INCL. [16293]	-	2Kg/4.4lb	20	⊕

VERSUS

OUT DOOR



pag 168

Pepe
Llaudet

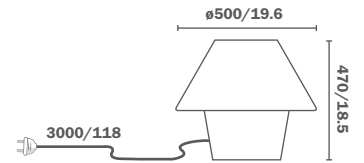

TABLE LAMP	Finish	Reference	Material	Bulb	Gear	Weight	IP	Class
	WHITE	74423	PEMD	1xE27 MAX 15W NOT INCL.	-	3.4Kg/7.5lb	44	⊕

WINCH



pag 58

Manel
LLuscà

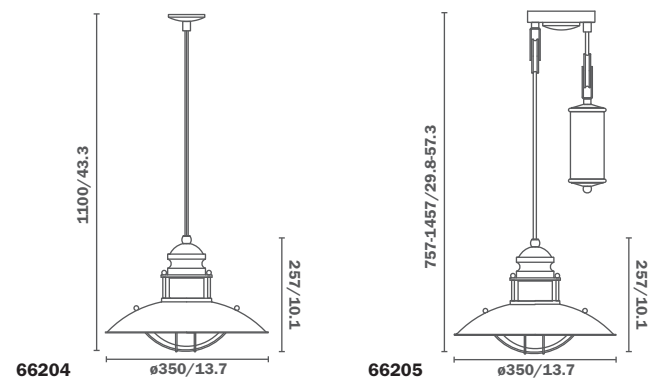

PENDANT LAMP	Finish	Reference	Material	Bulb	Gear	Weight	IP	Class
	DARK BROWN	66204	MET/GLASS	1xE27 MAX 60W NOT INCL. [16166]	-	2.4Kg/5.3lb	20	⊕
	DARK BROWN	66205	MET/GLASS	1xE27 MAX 60W NOT INCL. [16166]	-	5Kg/11lb	20	⊕

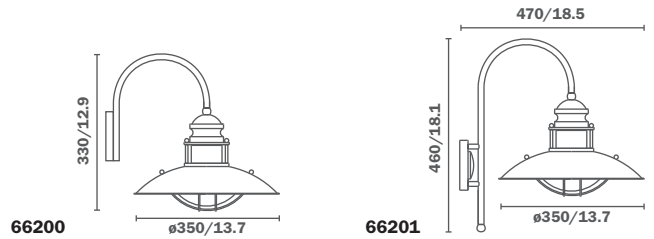

WALL LAMP	Finish	Reference	Material	Bulb	Gear	Weight	IP	Class
	DARK BROWN	66200	MET/GLASS	1xE27 MAX 60W NOT INCL. [16166]	-	2.5Kg/ 5.5lb	20	⊕
	DARK BROWN	66201	MET/GLASS	1xE27 MAX 60W NOT INCL. [16166]	-	2.7Kg/ 5.9lb	20	⊕

YAK OUT DOOR pag 92
Manel
LLusca

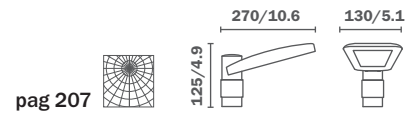

WALL LAMP	Finish	Reference	Material	Bulb	Gear	Weight	IP	Class
LED	WHITE	75105	DIE CAST AL/TRANSP POLYC	90 LED 6W 509Lm 4000K INCL.	DRIVER INCL.	1.2Kg/ 2.6lb	44	⊕
LED	DARK GREY	75106	DIE CAST AL/TRANSP POLYC	90 LED 6W 509Lm 4000K INCL.	DRIVER INCL.	1.2Kg/ 2.6lb	44	⊕

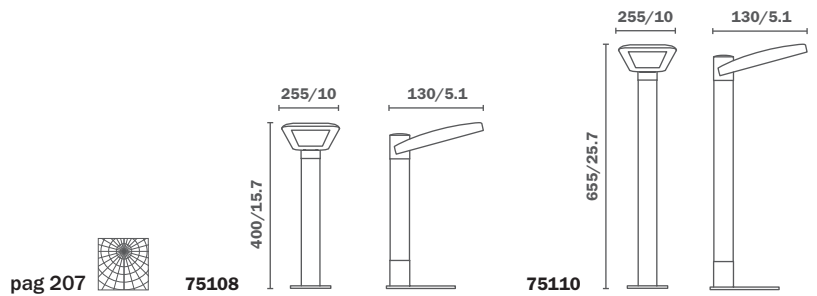

BEACON	Finish	Reference	Material	Bulb	Gear	Weight	IP	Class
LED	DARK GREY	75108	DIE CAST AL/TRANSP POLYC	90 LED 6W 509Lm 4000K INCL.	DRIVER INCL.	2Kg/ 4.4lb	44	⊕
LED	DARK GREY	75110	DIE CAST AL/TRANSP POLYC	90 LED 6W 509Lm 4000K INCL.	DRIVER INCL.	2.4Kg/ 5.3lb	44	⊕

FINISHES

Acabados
Finitions

BEIGE  Beige Beige	ORANGE  Naranja Orange	BORDEAUX  Bordeaux Bordeaux	MAGENTA  Magenta Magenta	MOSS GREEN  Verde Musgo Vert Mousse	MAY GREEN  Verde Mayo Vert Mai
GREEN  Verde Vert	DARK GREY  Gris Oscuro Gris Foncé	GRAPHITE  Grafita Graphite	DARK BROWN  Marrón oscuro Marron Foncé	RUST  Marrón Óxido Marron Rouille	CREAM  Crema Crème
WHITE ALUMINIUM  Aluminio Blanco Aluminium Blanc	GREY ALUMINIUM  Aluminio Gris Aluminium Gris	WHITE  Blanco Blanc	BLACK  Negro Noir	CHROME  Cromo Chrome	MATT NICKEL  Níquel Mate Nickel mat

MATERIALS





















Materiales
Matériel

ACRY Acrylic Acrílico Acrylique	ACRY PMMA Acrylic PMMA Acrílico PMMA Acrylique PMMA	AL Aluminium Aluminio Aluminium	DIE CAST AL Die Casting Aluminium Aluminio Inyectado Fonte d'aluminium	GLASS Glass Cristal Verre	OPAL GLASS Opal Glass Cristal Opal Verre opale
RUSTIC GLASS Rustic Glass Cristal Rústico Verre rustique	TEMP GLASS Tempered Glass Cristal Templado Verre Trempé	TRANSL GLASS Translucent Glass Cristal Translucido Verre Translucide	TRANSP GLASS Transparent Glass Cristal Transparente Verre Transparent	MET Metal Metal Métal	POLYC Polycarbonate Policarbonato Polycarbonate
OPAL PMMA Opal PMMA PMMA Opal PMMA Opale	OPAL POLYC Opal Polycarbonate Policarbonato Opal Polycarbonate Opale	TRANSL POLYC Translucent Polycarbonate Policarbonato Translucido Polycarbonate Translucide	TRANSP POLYC Transparent Polycarbonate Policarbonato Transparente Polycarbonate Transparent	PARCH Parchment Pergamino Parchemin	PEMD PEMD PEMD PEMD
PMMA PMMA PMMA PMMA	STEEL Steel Acero Acier	TEX Textile Textil Textile	WOOD Wood Madera Bois		





RECOMENDED BULBS

Bombillas recomendadas
Ampoules recommandée





ENERGY SAVING *Bajo consumo Economie d'énergie*

Reference	Bulb	Socket	W	K	LM	CD	Angle (°)	Diameter	Length	
16291		E14	11	2700	530	-	-	44 mm 1.7 inch	94 mm 3.7 inch	10/60
16269		E14	14	2700	800	-	-	80 mm 3.1 inch	115 mm 4.5 inch	5/20
16219		E27	14	2700	800	-	-	80 mm 3.1 inch	117 mm 4.6 inch	5/20
16292		E27	15	2700	800	-	-	44 mm 1.7 inch	104 mm 4.6 inch	10/60
16322		E27	15	2700	800	-	-	42 mm 1.6 inch	105 mm 4.1 inch	10/60
16166		E27	15	2700	800	-	-	48 mm 1.8 inch	110 mm 4.3 inch	10/60
16466		E27	15	5000	800	-	-	48 mm 1.8 inch	110 mm 4.3 inch	10/60
16285		E27	20	2700	850	-	-	120 mm 4.7 inch	134 mm 5.2 inch	1/5
16167		E27	20	2700	1150	-	-	48 mm 1.8 inch	110 mm 4.3 inch	10/60
16177		E27	20	2700	1150	-	-	48 mm 1.8 inch	112 mm 4.4 inch	10/60
16293		E27	20	2700	1150	-	-	44 mm 1.7 inch	113 mm 4.5 inch	10/60
16212		E27	20	2700	900	-	-	100 mm 3.9 inch	135 mm 5.3 inch	5/20
16467		E27	20	5000	1150	-	-	48 mm 1.8 inch	110 mm 4.3 inch	10/60
16464		E27	23	5000	1370	-	-	48 mm 1.8 inch	140 mm 5.5 inch	10/60
16218		E27	30	2700	1900	-	-	120 mm 4.7 inch	175 mm 6.8 inch	5/20
13027		G9	9	2700	405	-	-	34 mm 1.3 inch	86 mm 3.3 inch	10/50
14029		GU10	11	2700	200	-	-	50 mm 1.9 inch	74 mm 2.9 inch	1/5
14030		GU10	11	5000	200	-	-	50 mm 1.9 inch	74 mm 2.9 inch	1/5
15925		2G11	55	5000	3700	-	-	38 mm 1.9 inch	535 mm 2.9 inch	1/3
15907		G24q-2	18	4000	1170	-	-	28 mm 1.1 inch	163 mm 6.4 inch	1/10

LED

Reference	Bulb	Socket	W	K	LM	CD	Angle (°)	Diameter	Length	
14149		E27	8	4000	810	-	-	125 mm 4.9 inch	127 mm 5 inch	1/1
14140		GU10	5	2700	300	-	60	50 mm 1.9 inch	56 mm 2.2 inch	1/1
14141		GU10	5	4000	340	-	60	50 mm 1.9 inch	56 mm 2.2 inch	1/1

ECOHALOGEN *Ecohalógenas Halogènes*

Reference	Bulb	Socket	W	K	LM	CD	Angle (°)	Diameter	Length	
15616		G9	42	2700	630	-	-	13 mm 0.5 inch	45 mm 1.7 inch	1/10
14101		GU10	50	2800	-	1200	20	50 mm 1.9 inch	56 mm 2.2 inch	1/10
14115		GU10	50	2800	-	2000	20	50 mm 1.9 inch	56 mm 2.2 inch	1/10

PHOTOMETRICS
Fotométricas
Photométriques

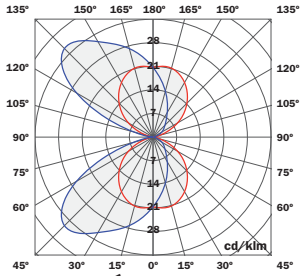

ÁNCORA
74401

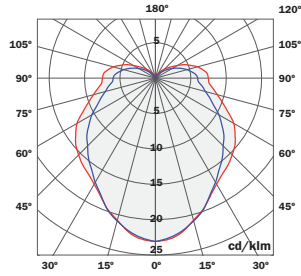

BOLETUS
74391/74392/74394

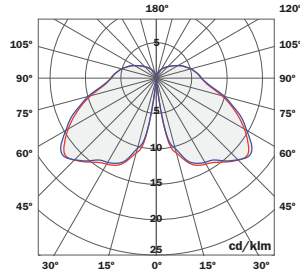

BOLETUS
74393/74395

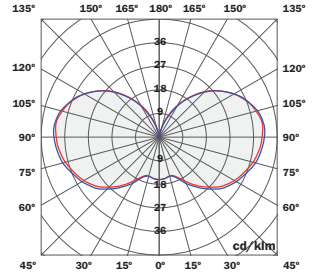

CROSS
74350/74351

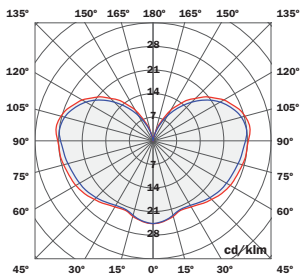

CROSS
74353

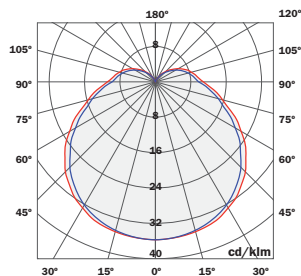

CROSS
74355

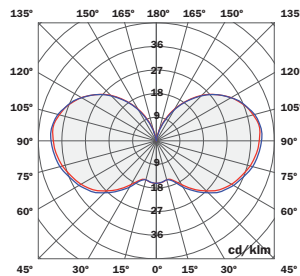

CROSS
74356/74357

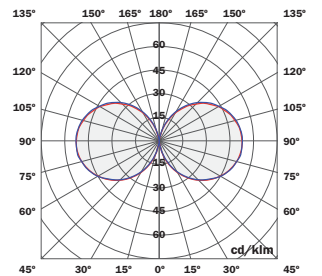

CROSS
74349/74359

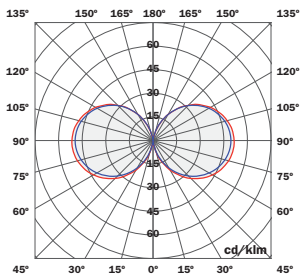

CROSS
74358

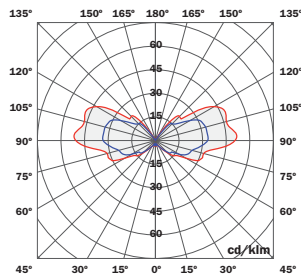

KIT CROSS
74369

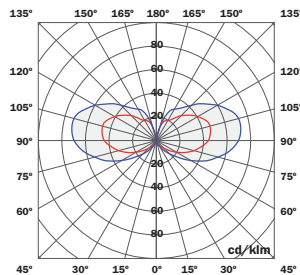

KIT CROSS
74370

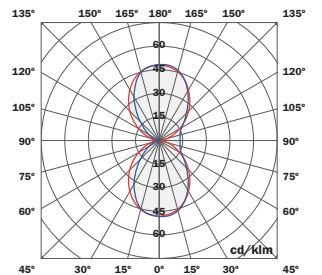

DRAGMA
71362

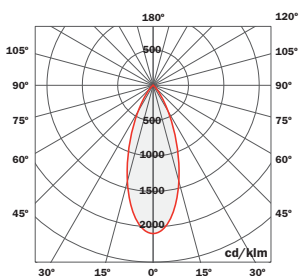

FOKUS
01041501/ 01041502/
01041503

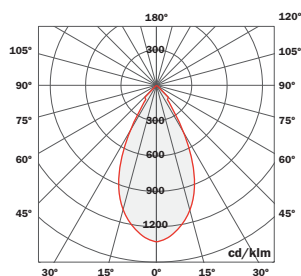

FOKUS
01040201/ 01040202/
01040203

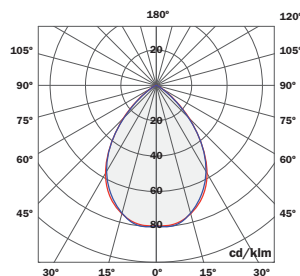

KLAMP
74407

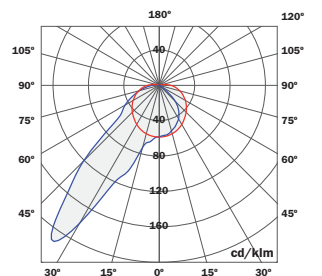

KLAMP
74409/74410/74411/ 74412/ 74413

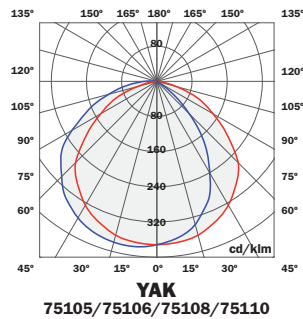
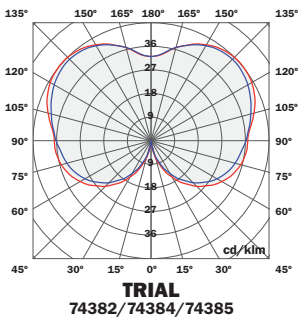
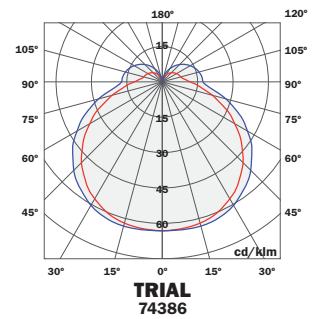
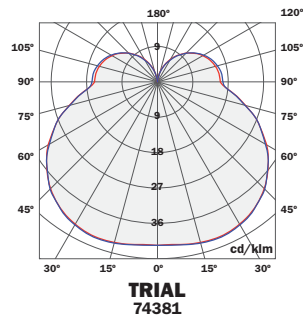
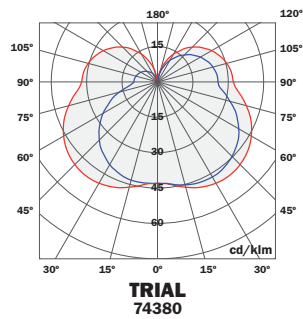
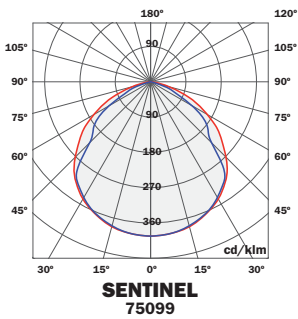
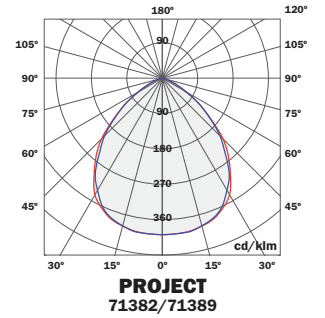
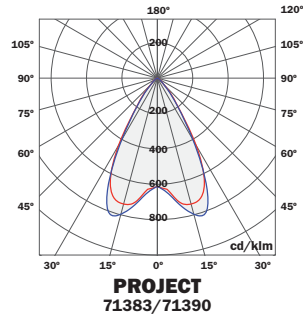
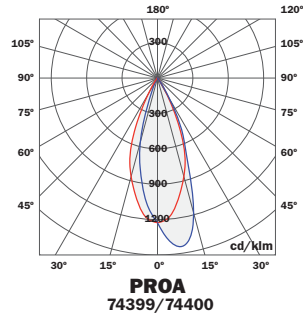
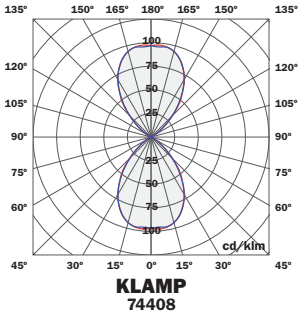



faro.es