



News 2014

ÍNDICE

DEC 01

Wire Light 05
Aspen 09
Scout 13
Phi 15
Hoodie 19
Tree Series 23
Grand Canal 28

Classics 29

Olympia 33
Regina 35
Bluebird 37
Taps 38

Rediscover 39

Nite 43
Q.Bo 44
Boletus 45
Ronda 46
Olsen 47
Eliana 49
Ilde Wood 51
Centra / Minicentra 53
Petite / Petite Led 55
Round White 56
Helios 57
Roof 58
Julia & Julieta 60

TECH 61

Anvil System 65
Deep Cove System 71
Deep System 75
Deep R 78

Outdoor 79

Magnet 83
Lap Bench 85
AMS 87
Frame 89
Junko 91
20/20 93

DEC

Wire Light
Aspen
Scout
Phi
Hoodie
Tree Series
Grand Canal

Las recientes colaboraciones con diseñadores internacionales han dotado a la nueva colección de luminarias decorativas de B.lux de un espíritu renovado.

Son el avance de una nueva serie de luminarias de diseño diferenciado y especialmente concebidas para combinar funcionalidad y eficiencia. Su propósito, integrarse en espacios contemporáneos y dotarlos de personalidad.

Recent collaborative efforts with international designers have infused B.lux's new decorative lamp collection with a fresh spirit. These are indicative of a new series of lamps featuring designs that stand out and are specially conceived to fuse functionality and efficiency. Their purpose: integration into contemporary spaces, providing them with personality.

In jüngster Zeit hat die Zusammenarbeit mit internationalen Designern innovativen Geist in die Kollektion dekorativer Leuchten von B.lux gebracht. Sie bilden die Vorhut einer neuen Reihe ansprechend anderer Designerleuchten, die gezielt auf die Synthese von Funktionalität und Effizienz hin konzipiert sind. Vorgabe ist: Sie sollen sich in Räume von heute integrieren und ihnen zugleich eine persönliche Note geben.

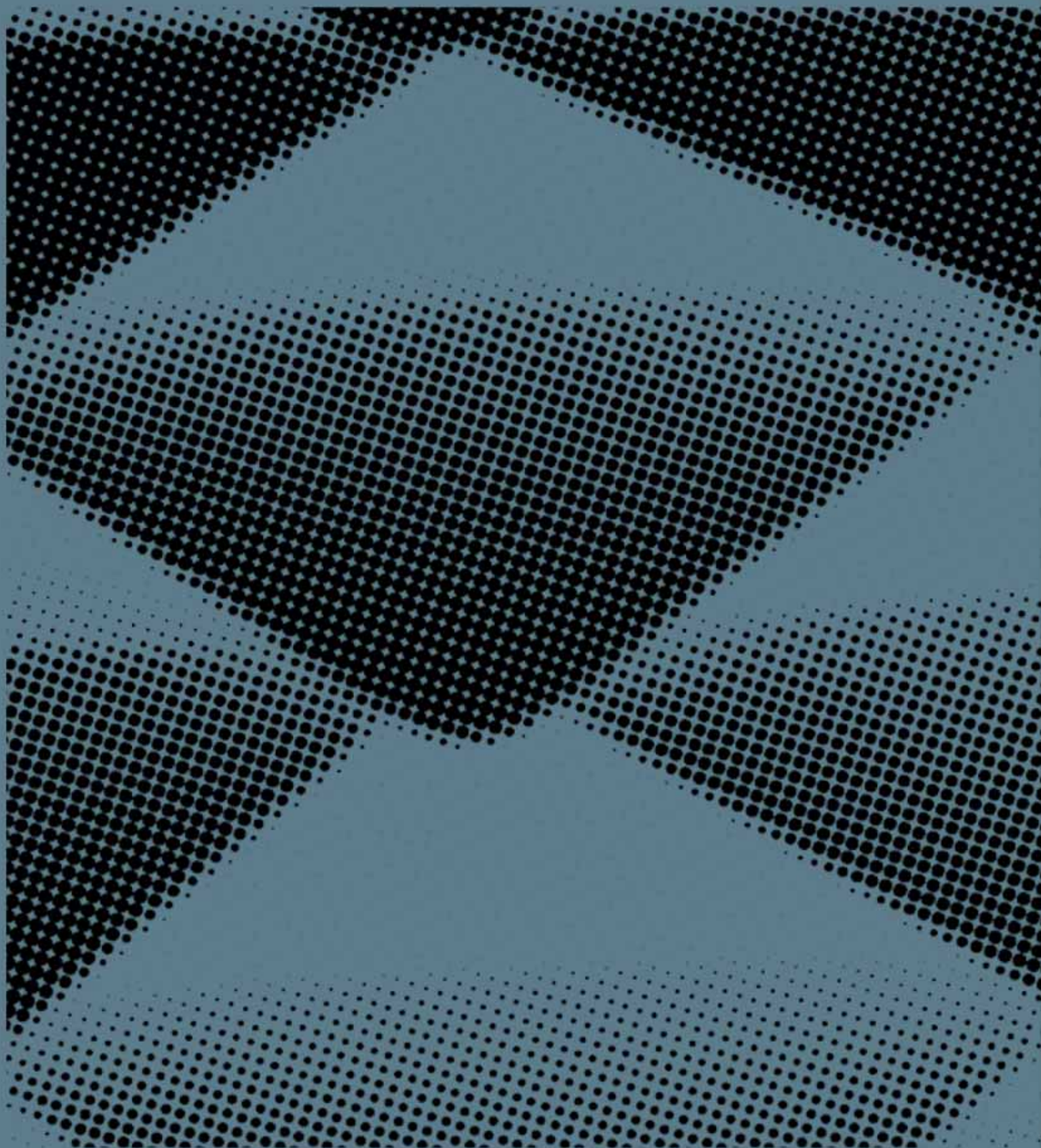





Wire Light

David Abad

Familia de luminarias con pantalla de malla metálica, combinada con pantalla interior textil. Trípode de madera de roble.

Acabados: pantalla exterior blanca, negra, beige, azul o verde, combinada con pantalla interior y cable textil del mismo tono.

A family of lamps featuring metal mesh shade combined with fabric interior shades. Oak tripod.

Finishes: exterior shade in white, black, beige, blue or green, combined with interior shade and textile cable in the same tone.

Leuchtenfamilie mit Metallnetzschild in Kombination mit innerem Textilschild. Eichenholzstativ.

Ausführungen: äußerer Schild in Weiß, Schwarz, Beige, Blau, oder Grün in Kombination mit Innenschild und Textilkabel in derselben Farbe.

T30: Halóg. ECO máx 60W (G9)
o Fluor. 9W (G9)

T40: Halóg. ECO máx. 70W (E27)
o Fluor. 23W (E27)

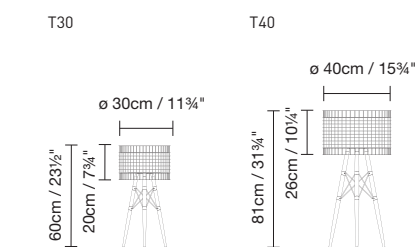

C30: Halóg. ECO 80W (R7s) 78 mm o LED 17,5W 1300 lm 3000K
C45: Halóg. ECO máx. 130W (R7s) o LED 22W 230V 3000K
C70: Halóg. ECO máx. 130W (R7s) o LED 30W 230V 3000K

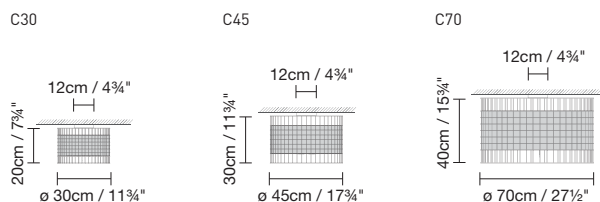

S30: Halóg. ECO 80W (R7s) 78 mm o LED 17,5W 1300 lm 3000K
S45: Halóg. ECO 80W (R7s) 78 mm o LED 17,5W 1300 lm 3000K
S70: Halóg. ECO máx. 130W (R7s) o LED 30W 230V 3000K

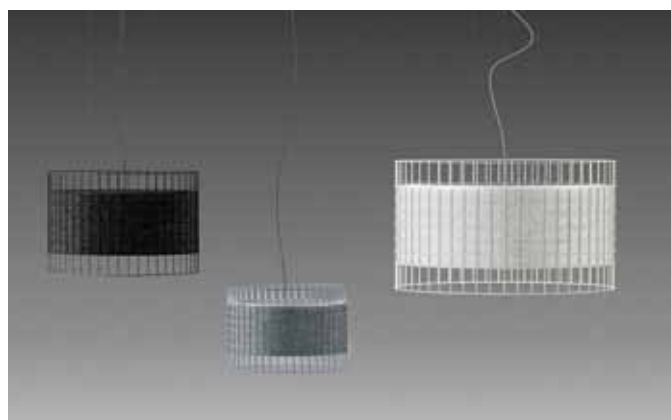
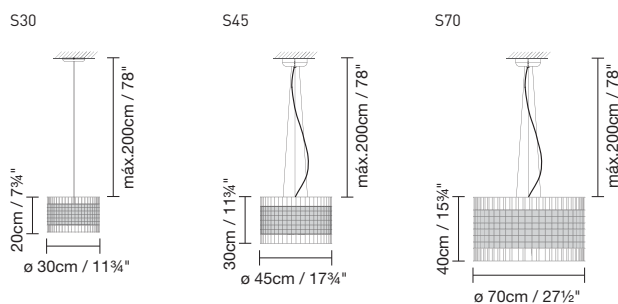



- ◊ F45: Halóg. ECO máx. 150W (E27)
 o Fluor. 26W (E27)
 F70: Halóg. ECO 3 x máx. 150W (E27)
 o Fluor. 3 x 26W (E27)

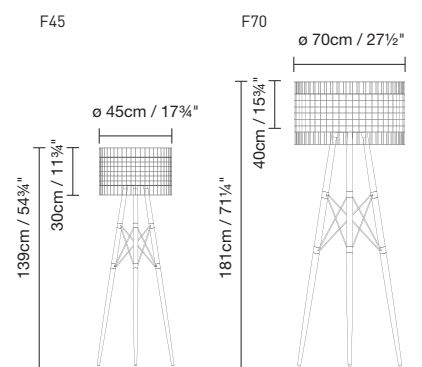

Familia de luminarias de doble pantalla. Luz directa y difusa (plafón y suspensión), y luz directa e indirecta (pie).

Acabados: Lacado mate, con diferentes combinaciones.

A line of dual shade lamps. Direct and diffused light (ceiling and suspension), and direct and indirect light (floor).

Finishes: Matte lacquer, with different combinations.

Leuchtenfamilie mit doppeltem Schirm. Direktes Licht und Streulicht (Decken- und Hängeleuchte) sowie direktes und indirektes Licht (Stehleuchte).

Ausführungen: Matt lackiert, verschiedene Kombinationen.

- ◊ F17: Fluor. 30W (E27)
o Halóg. ECO máx. 70W (E27)
F40: Fluor. 3 x 23W (E27)
o Halóg. ECO máx. 3 x 28W (E27)

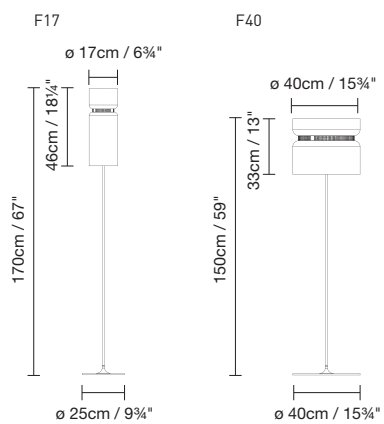



Aspen

Werner Aisslinger



◇ C17A: Fluor. 30W (E27) o Halóg. ECO máx. 70W (E27)
C17B: Fluor. 30W (E27) o Halóg. ECO máx. 70W (E27)
C40: Halóg. máx. 130W (R7s) o LED 22W 230V 3000K

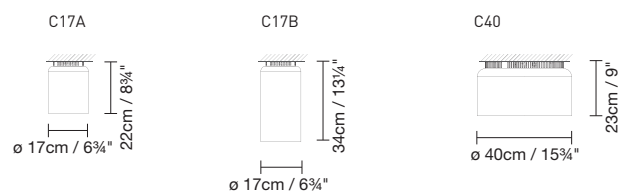



- ◆ S17A: Fluor. 30W (E27) o Halóg. ECO máx. 70W (E27)
 S17B: Fluor. 30W (E27) o Halóg. ECO máx. 70W (E27)
 S40: Halóg. máx. 130W (R7s) o LED 22W 230V 3000K

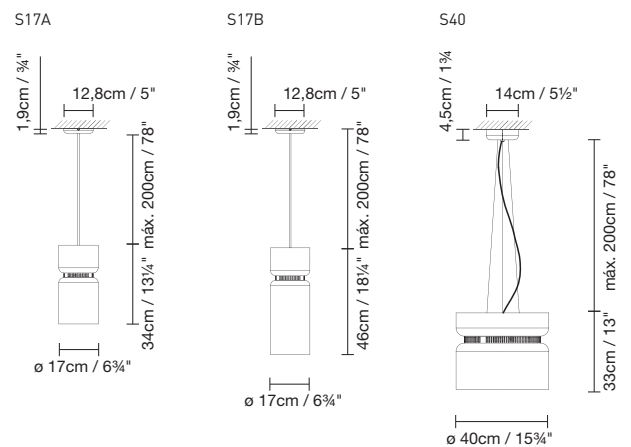

Luminaria de suspensión orientable, de estructura metálica y difusor de vidrio.

Acabados: beige, rojo o gris mate, todos con interior blanco.

Adjustable suspension lamp with a metal structure and glass diffuser.

Finishes: matt beige, grey or red with white interior.

Ausrichtbare Hängeleuchte mit Metallstruktur und Glasdiffusor.

Ausführungen: Beige, grau oder matt rot, innen weiß.

Halóg. ECO máx. 150W (E27)
o LED 22W 230V 3000K

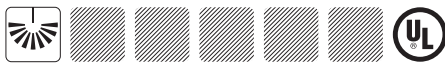
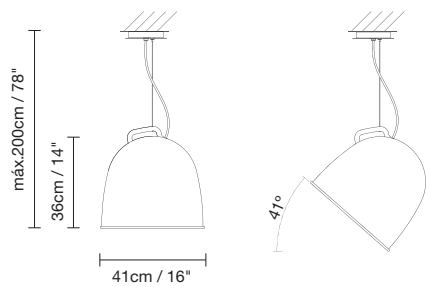

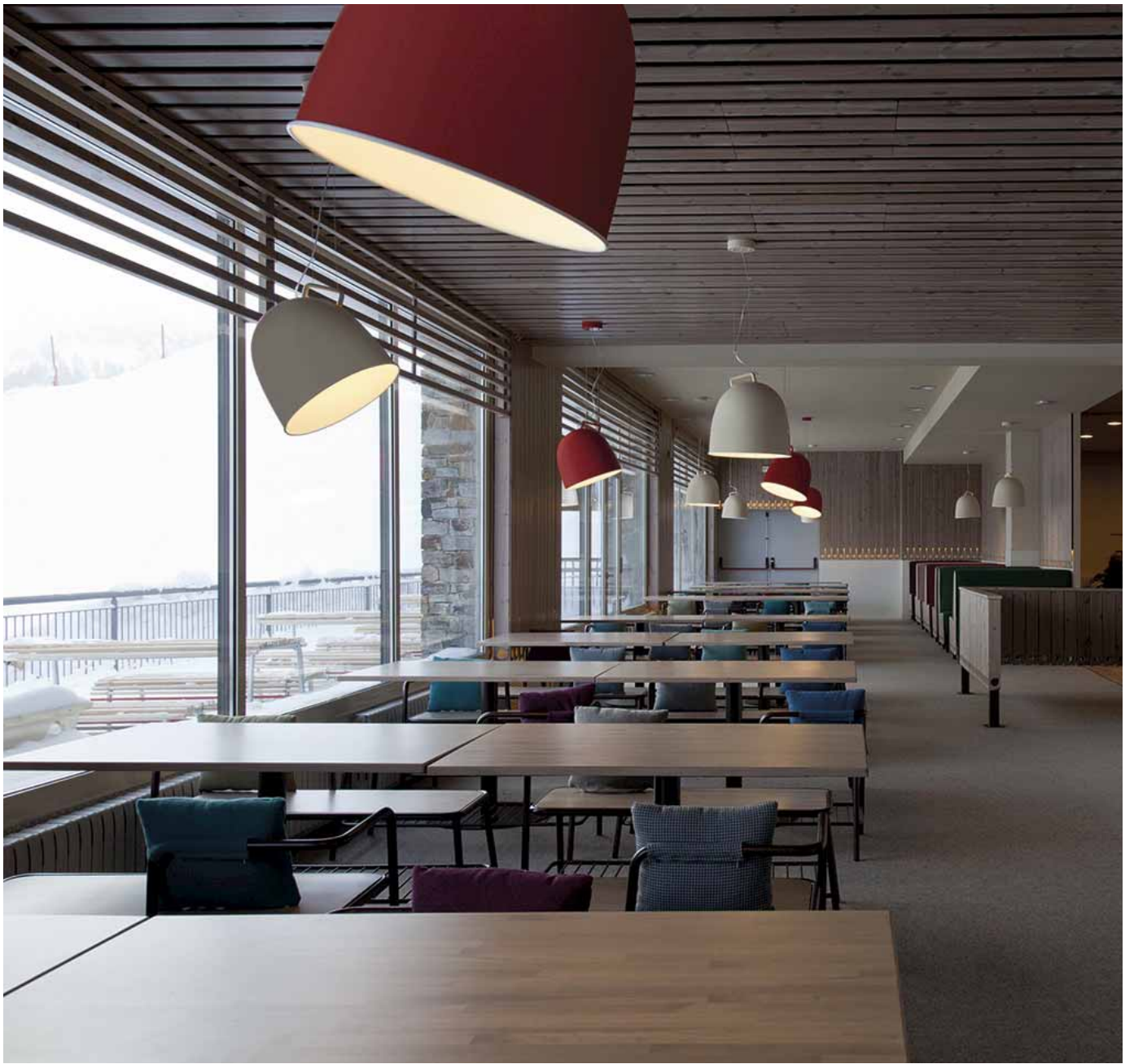

Scout

Stone Design

Colección de luminarias de inspiración escandinava de estructura metálica y ABS.

Acabados: blanco o beige texturado con cable textil. Otros acabados, consultar.

A Scandinavian-inspired lamp collection featuring metallic structures and ABS.

Finishes: Textured white or beige with textile cable. Inquire about other finishes.

Leuchtenkollektion mit skandinavischem Einschlag, Metallstruktur und ABS.

Ausführungen: Weiß oder beige, Textilkabel. Weitere Ausführungen auf Anfrage.

S40: Halóg. ECO máx. 150W (E27) o Fluor. 30W (E27)
S60: Halóg. ECO máx. 3 x 150W (E27) o Fluor. 3 x 30W (E27)
S80: Halóg. ECO máx. 4 x 150W (E27) o Fluor. 4 x 30W (E27)

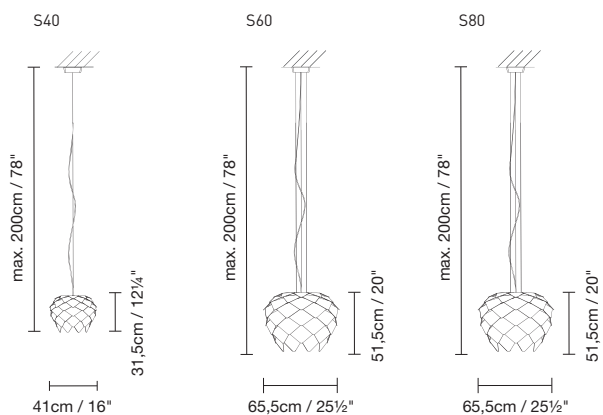



Phi

David Abad



W40/C40: Halóg. ECO 150W (E27)
o LED 17,5W 230V 3000K

W40

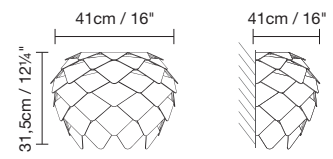

C40

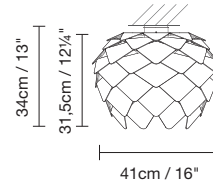



◆ T40: Halóg. ECO máx. 100W (E27) o Fluor. 30W (E27)
 F40: Halóg. ECO máx. 100W (E27) o Fluor. 30W (E27)
 F60: Halóg. ECO máx. 3 x 100W (E27) o Fluor. 3 x 30W (E27)

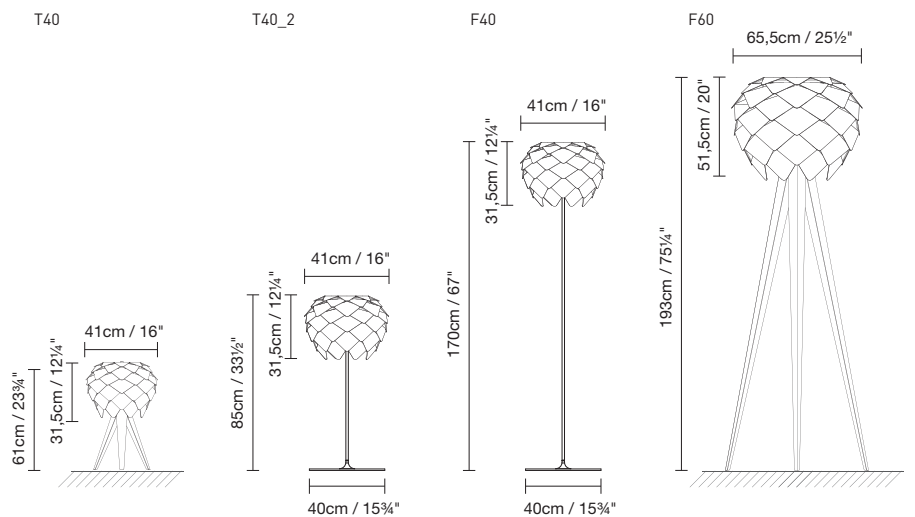

Colección de luminarias de iluminación indirecta y estética vintage.

Acabados: blanco mate, negro mate y beige mate, con cable textil del mismo tono.

A lamp collection featuring indirect lighting and a vintage aesthetic.

Finishes: matte white, matte black and matte beige, with textile cable in the same tone.

Leuchtenkollektion für indirekte Beleuchtung mit Vintage-Ästhetik.

Ausführungen: jeweils mattes Weiß, Schwarz und Beige mit Textilkabel in der entsprechenden Farbe.

 T: Fluor. 2 x máx. 20W (E27)

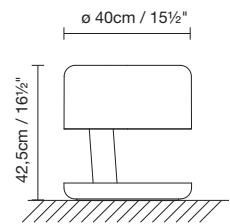





Hoodie

Werner Aisslinger

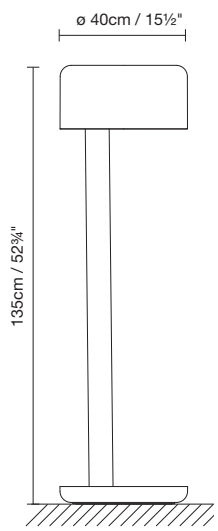
◊ F: Fluor. 2 x máx. 24W (E27)

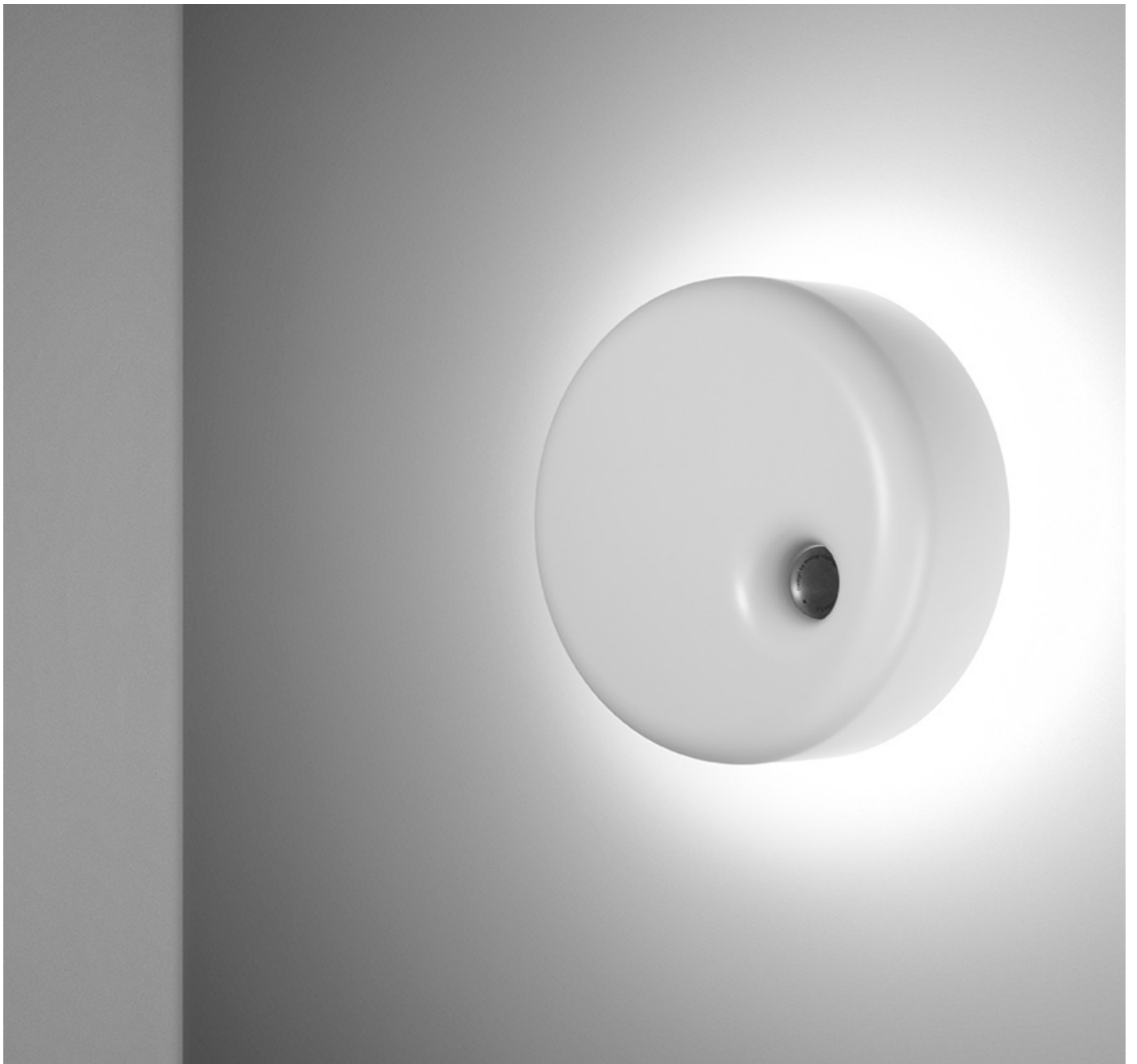



 C/W: Fluor. circ. 55W (2Gx13)

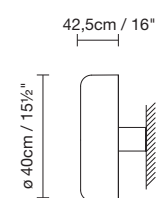

Familia de luminarias de estética orgánica, con pantalla de aluminio y estructura en poliuretano. Luz directa y reflejada.

Acabados: monocolor blanco o negro texturado mate, y bicolor blanco o negro texturado con interior dorado. Cables textiles del mismo tono.

* Tree Series 35 se fabrica solo en acabado monocolor.

A family of lamps with an organic aesthetic, featuring an aluminium shade and a polyurethane structure. Direct and reflected light.

Finishes: monochrome white or textured matte black, and two-toned black or white, with gold interior. Textile cables in the same tone.

* Tree Series 35 is manufactured only in monochromatic finishes.

Leuchtenfamilie mit organischer Ästhetik. Aluminiumschirm und Struktur aus Polyurethan. Direktes Licht und Reflektor.

Ausführungen: einheitlich Weiß oder Schwarz, matt texturiert, oder zweifarbig Schwarz und Weiß, texturiert, innen vergoldet. Textilkabel in der jeweils entsprechenden Farbe.

* Tree Series 35 wird nur in einfarbiger Ausführung hergestellt.

S35: Halóg. ECO 80W (R7s) 78 mm o LED 17,5W 1300 lm 3000K
 S50: Halóg. ECO máx. 130W (R7s) o LED 22W 230V 3000K
 S75: Halóg. máx. 2 x 130W (R7s) o LED 30W 230V 3000K

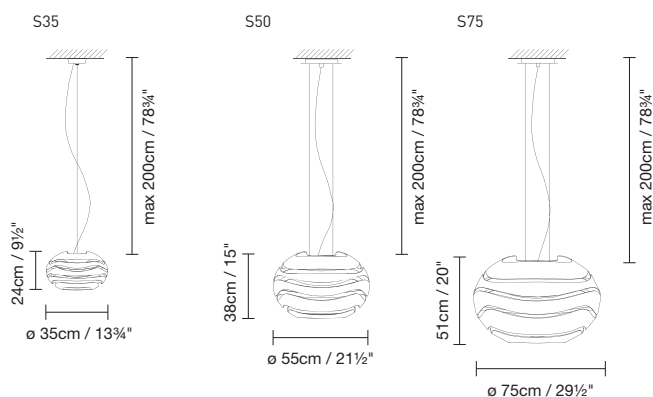



Tree Series

Werner Aisslinger

◊ C35: Halóg. ECO 80W (R7s) 78 mm
o LED 17,5W 1300 lm 3000K
C50: Halóg. máx. 130W (R7s)
o LED 30W 3000 lm 3000K

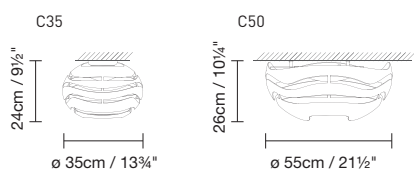

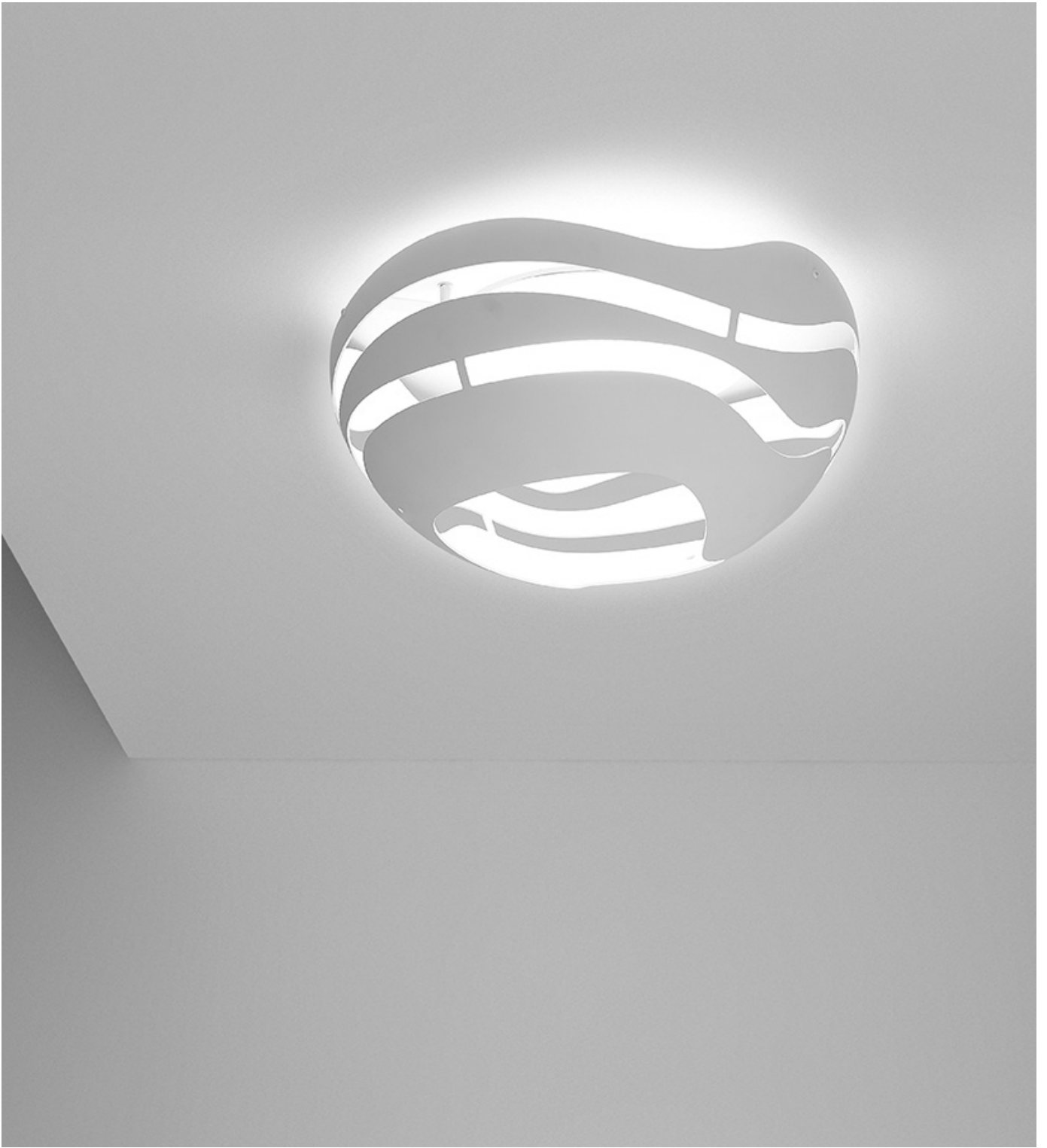



◊ T35: Halóg. máx. 60W (G9)
 T50: Halóg. ECO máx. 150W (E27)

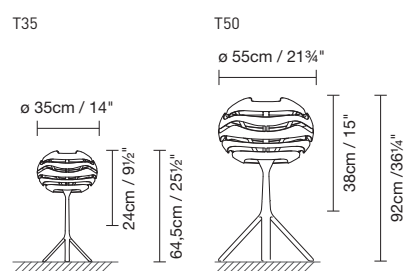



◊ F50: Halóg. ECO máx. 150W (E27)

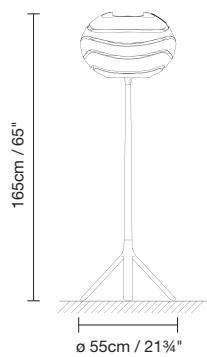



Grand Canal

Moneo & Brock Studio

LED 42 x 1,05W 350 mA

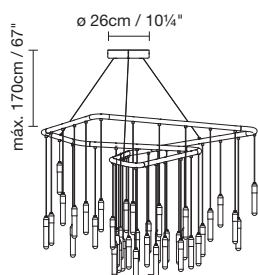
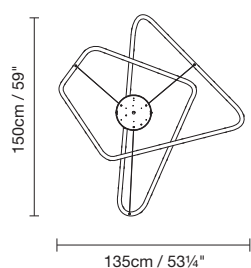

Luminaria de suspensión múltiple de estructura tubular y fuente de luz LED con difusor de vidrio pyrex.

Acabados: blanco mate.

A multiple suspension lamp featuring a tubular structure, LED light source, and a Pyrex glass diffuser.

Finishes: matte white.

Mehrteilige Hängeleuchte mit Röhren-Metallstruktur, LED-Leuchten und Diffusor aus Pyrex-Glas.

Ausführungen: mattes Weiß.



Classics

Olympia
Regina
Bluebird
Taps

De diseño atemporal y altamente innovadoras, fueron las primeras luminarias de aluminio pulido del mercado, marcando una tendencia que se generalizaría en años sucesivos. Estas colecciones de los años 80 lograron un gran reconocimiento internacional, al tiempo que marcaron un antes y un después en la trayectoria de B.lux.

En esta nueva etapa, B.lux reedita sus luminarias icono con sugerentes acabados que dejan al descubierto la nobleza de sus materiales, y adaptándose a nuevas fuentes de luz sostenibles.

With timeless designs and yet highly innovative, these were the first polished aluminium lamps on the market, setting a trend that would surge in the years to follow. These collections from the 1980s garnered major international acclaim, while marking a turning point in B.lux's history.

During this new stage B.lux is rereleasing its signature lamps, with appealing finishes that reveal the quality of their materials, while adapting them to accommodate new, sustainable light sources.

Zeitloses Design und hochgradig innovativ: Das zeichnete die ersten Leuchten aus polierten Aluminium auf dem Markt aus, und dieser Trend sollte in den folgenden Jahren weite Verbreitung finden. Diese Kollektionen aus den 80er Jahren fanden international viel Anerkennung, und zugleich bilden sie eine Zäsur in der Entwicklung der Marke B.lux.

Es begann eine neue Etappe, in der B.lux seine bekanntesten Leuchten mit ansprechendem Finish neu auflegt: Ausführungen, die offen die edlen Materialien zeigen, und die zugleich auf neue, nachhaltige Leuchtmittel abgestimmt sind.

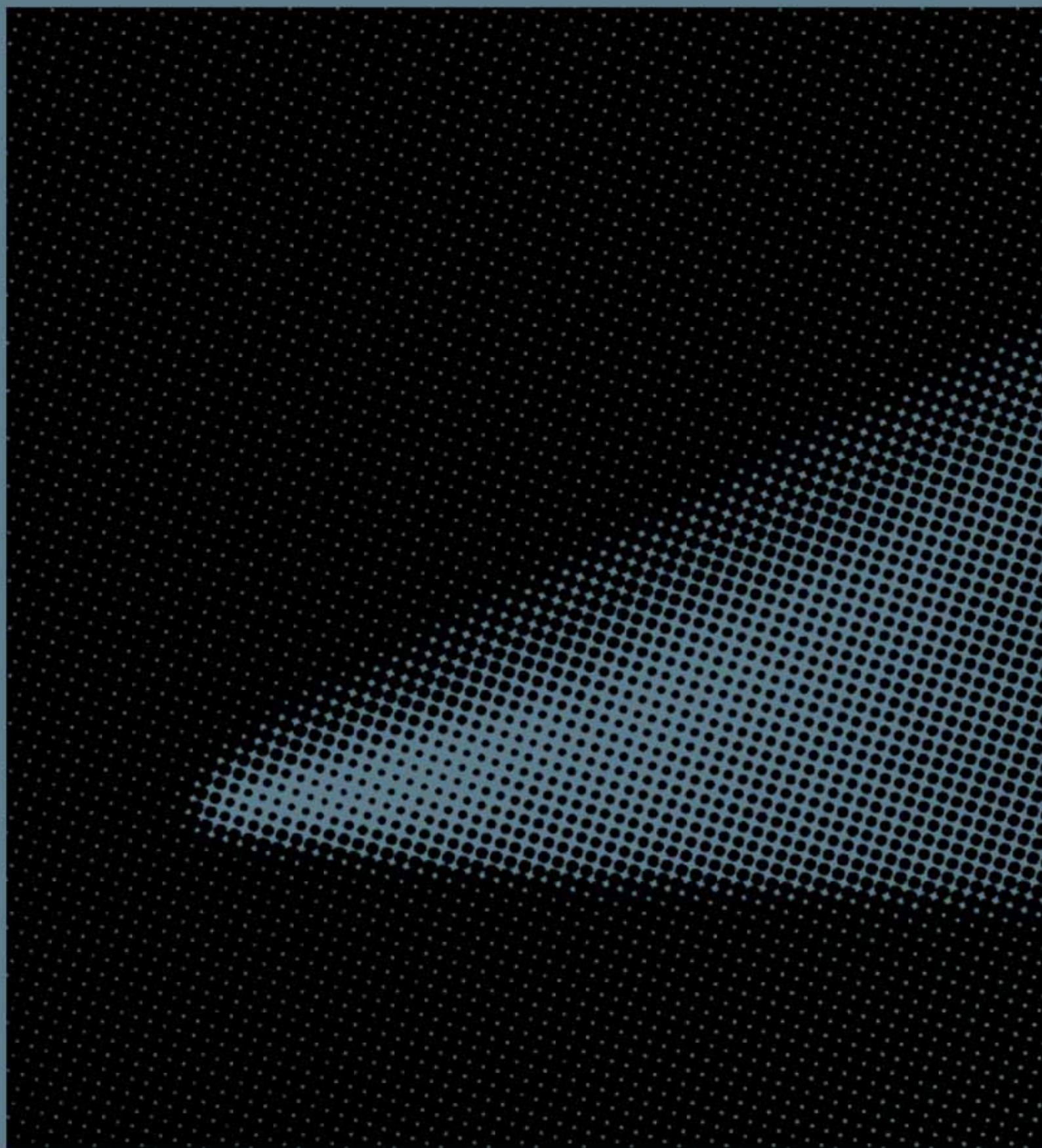



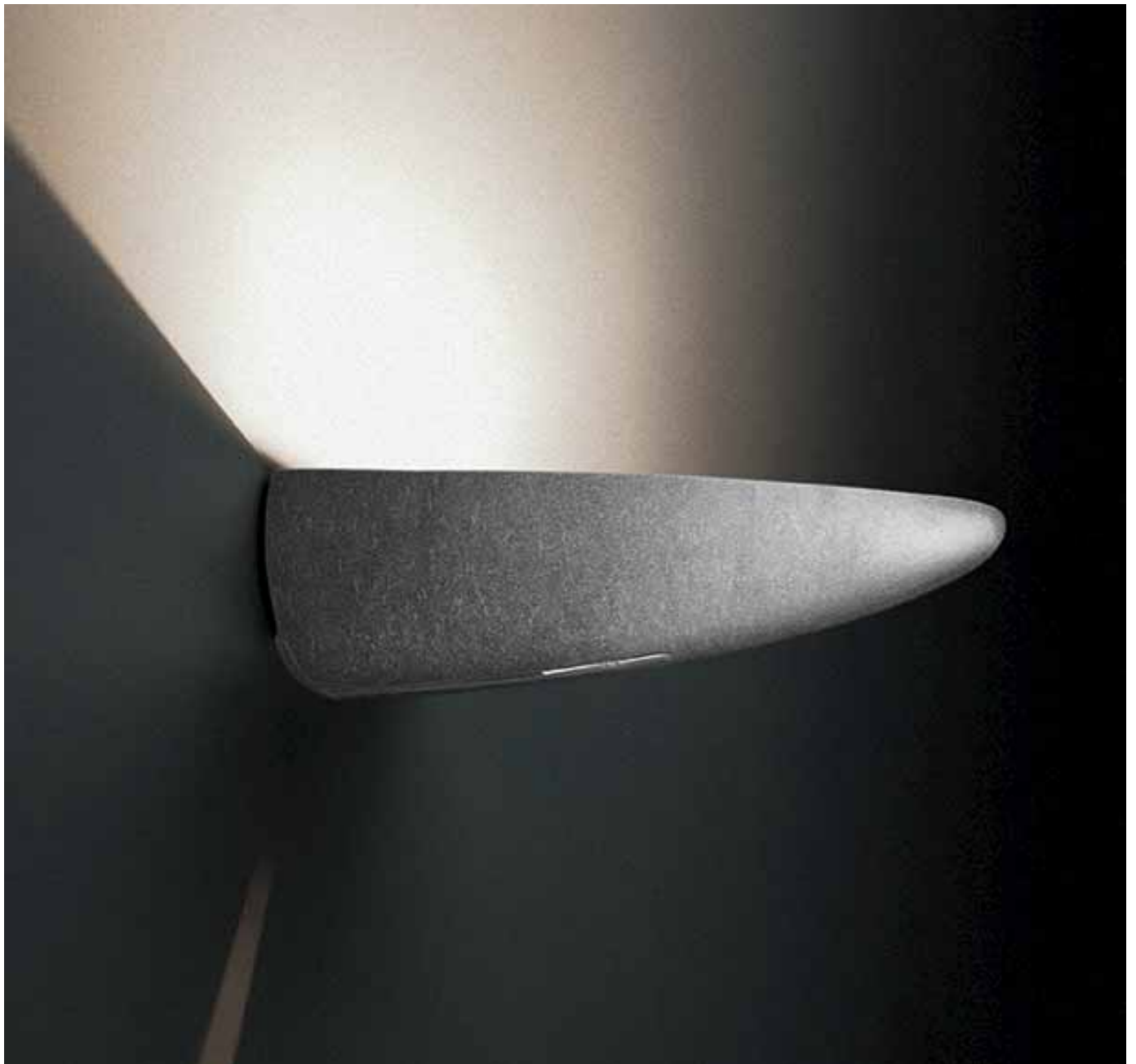

Olympia

Jorge Pensi



 S: Halóg. ECO 2 x máx. 130W (R7s)
 W: LED 13W 940 lm 230V 3000K

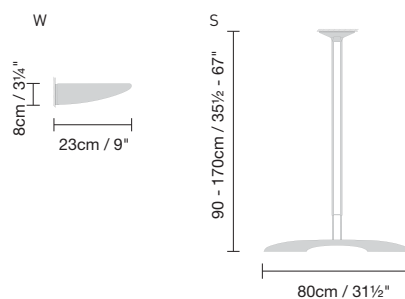

Luminaria de suspensión y aplique, fabricadas en aluminio inyectado.

Acabados: Nuevo acabado industrial. También disponible en aluminio pulido brillante.

Suspension and wall lamp, manufactured in die cast aluminium.

Finishes: New industrial finish. Also available in shiny polished aluminium.

Wand- und Hängeleuchte aus Druckguss-Aluminium.

Ausführungen: Neue Industriedesign-Gestaltung. Auch in glänzend poliertem Aluminium lieferbar.

Luminaria de mesa y aplique de luz indirecta, fabricada en aluminio inyectado.

Acabados: Nuevo acabado industrial. También disponible en aluminio pulido brillante.

Table and indirect wall lamp, manufactured in die cast aluminium.

Finishes: New industrial finish. Also available in shiny polished aluminium.

Tischleuchte und Wandleuchte mit indirektem Licht, hergestellt aus Druckguss-Aluminium.

Ausführungen: Neue Industriedesign-Gestaltung. Auch in glänzend poliertem Aluminium lieferbar.

T: LED 7,5W 3000K
W: LED 17,5W 1300 lm 230V 3000K

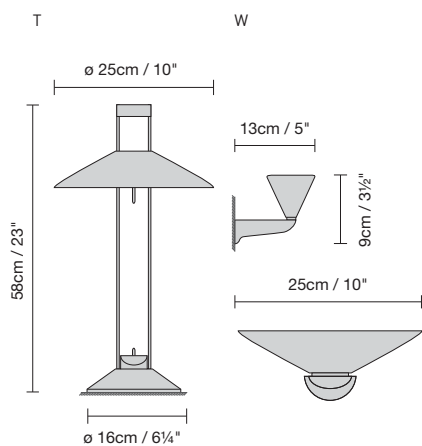



Regina

Jorge Pensi

Luminaria de mesa de estructura metálica y madera.

Acabados: Nuevo acabado industrial con madera de roble natural. También disponible en madera caoba con metal cromo brillo.

Table lamp with a metal and wood structure.

Finishes: New industrial finish in natural oak. Also available in mahogany with glossy chrome metal.

Tischleuchte, Struktur aus Metall und Holz.

Ausführungen: Neue Industriedesign-Gestaltung mit naturbelassenem Eichenholz. Auch in Mahagoni mit glänzend verchromtem Metall erhältlich.

LED 6,3W 660 lm 350mA 3000K CRI 80

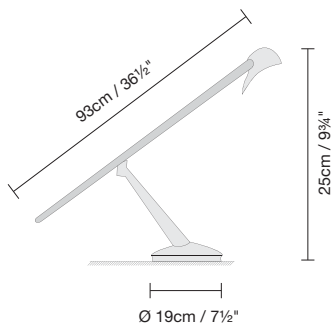



Bluebird

Jorge Pensi



Taps

Jorge Pensi

Luminaria de mesa y pie lectura.
Acabados: Nuevo acabado en negro mate.
 También disponible en cromo brillo.

Table and floor/reading lamp.
Finishes: New finish in matte black. Also
 available in glossy chrome.

Leseleuchte als Tisch- und Stehleuchte.
Ausführungen: Neue Ausführung in mattem
 Schwarz. Auch glänzend verchromt erhältlich.

LED 6,3W 660 lm 350mA 3000K

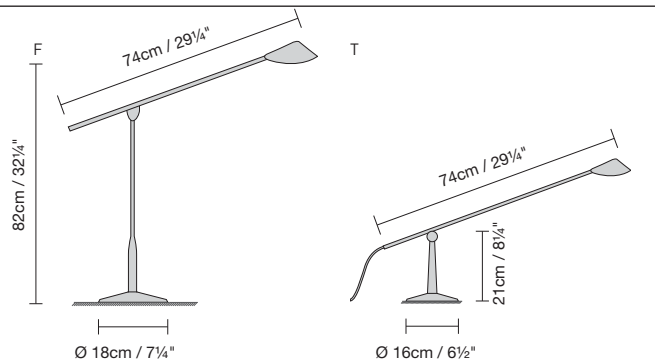

Rediscover

Nite
Q.Bo
Boletus
Ronda
Olsen
Eliana
Ilde Wood
Centra
Minicentra
Petite
Petite Led
Round White
Helios
Roof
Julia & Julieta

B.lux renueva una selección de diseños de éxito, pertenecientes a diferentes épocas y creados por distintos diseñadores. El objetivo, adaptarse a las nuevas tendencias de diseño contemporáneo, tanto de ámbito doméstico como contract.

Redescubre los diseños más atractivos de B.lux, con un aire renovado.

B.lux gives a new twist to a series of successful designs from different periods and created by different designers. The objective is to adjust to the latest trends in contemporary design, with regards to both the domestic and contract work spheres.

Rediscover B.lux's most attractive designs, with a renewed air.

B.lux erneuert eine Auswahl erfolgreicher Designs aus verschiedenen Epochen und von unterschiedlichen Designern. Ziel ist die Aufnahme neuer, aktueller Designtrends im Wohn- und im Contractbereich.

Entdecken Sie die ansprechendsten Designs von B.lux in einem neuen Licht.

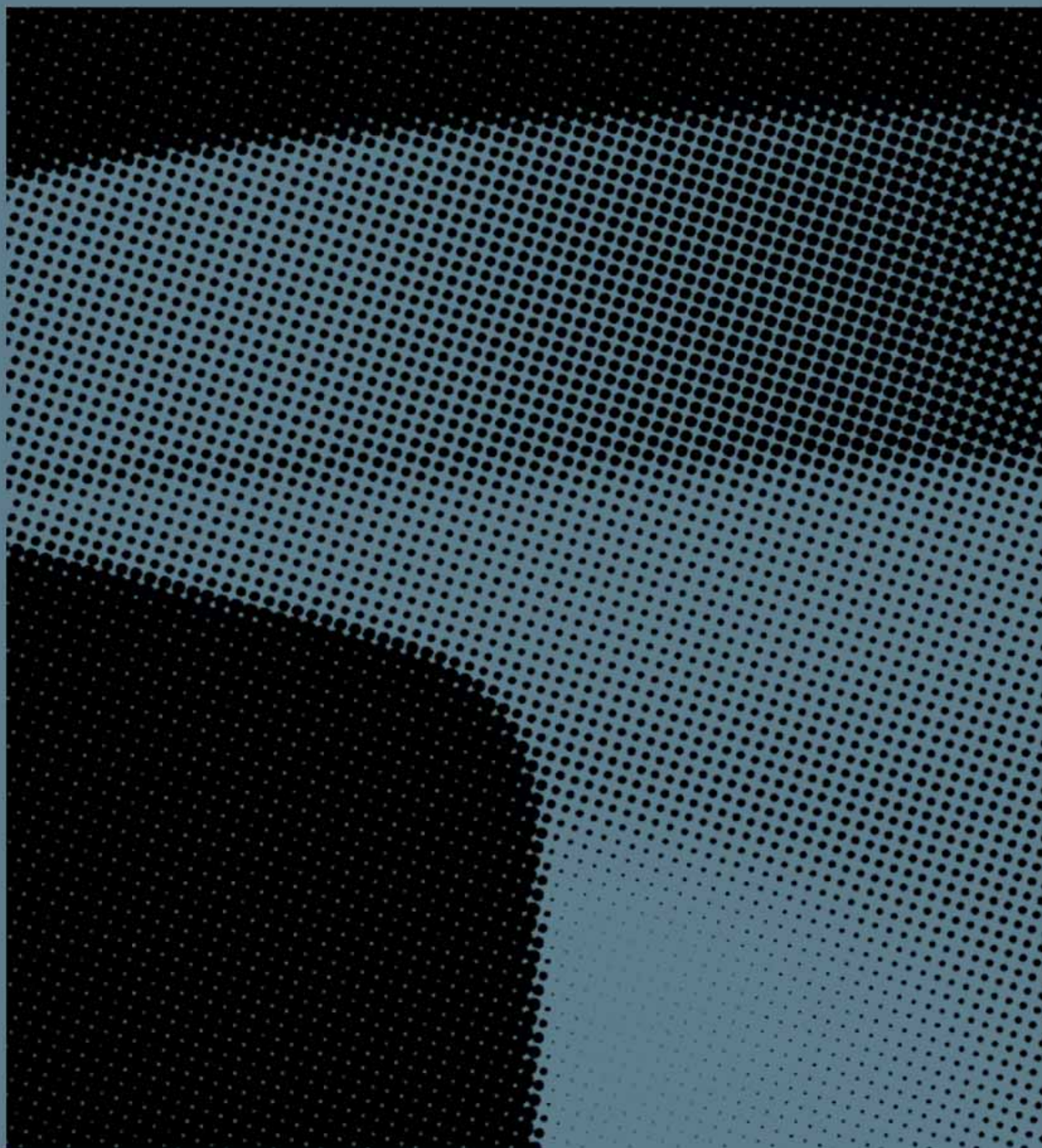

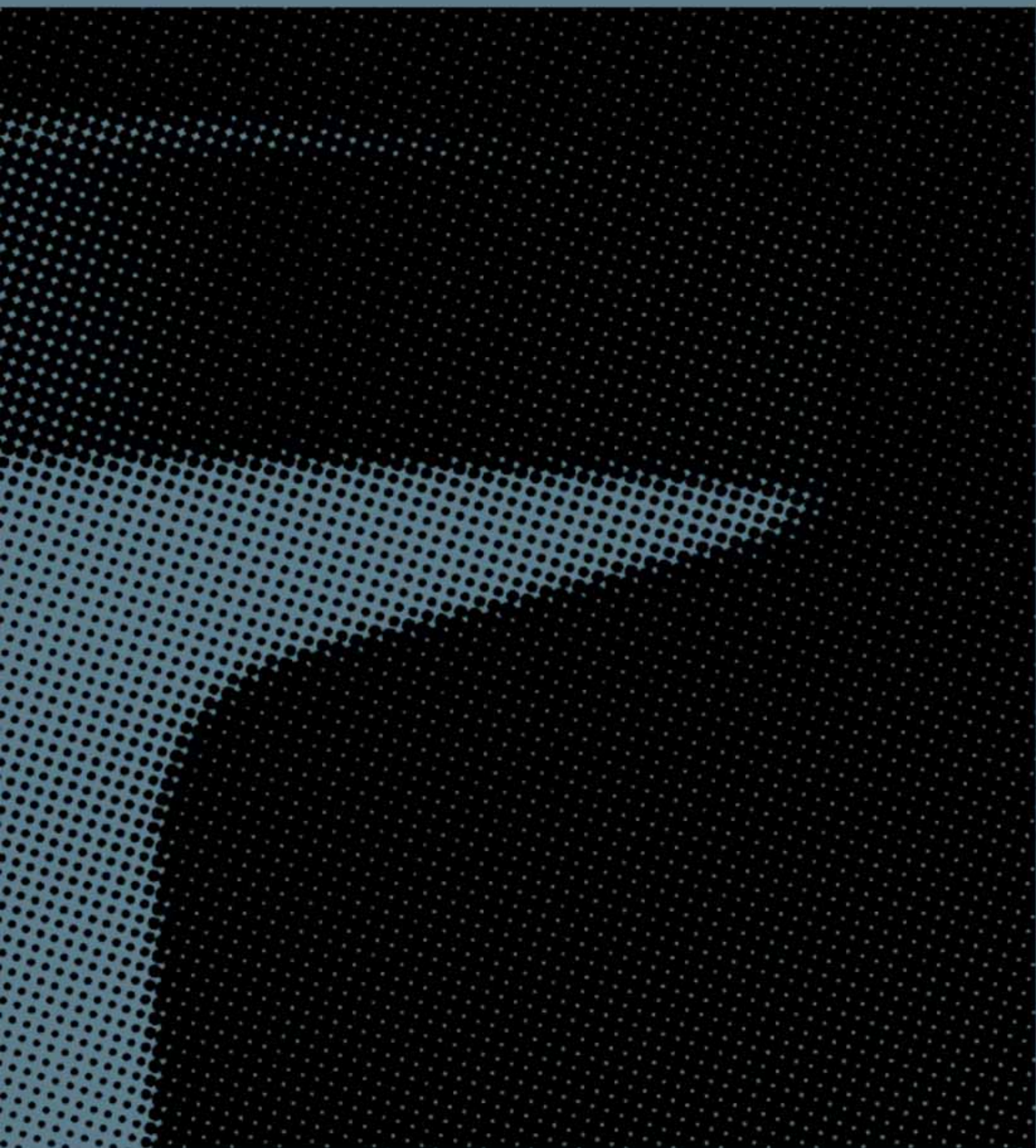



Nite

Jorge Pensi

 Fluor. Plumen 11W (E27)

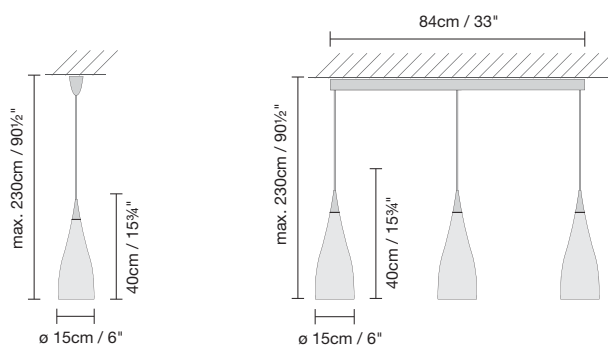

Luminaria de suspensión de vidrio soplado.

Acabados: Nuevo acabado con pantalla gris transparente y cable textil gris. También disponible en vidrio blanco opalino con cable plata.

Glass-blown suspension lamp.

Finishes: New finish with transparent grey shade and grey textile cable. Also available in opal white glass with grey cable.

Hängeleuchte aus geblasenem Glas.

Ausführungen: Neue Ausführung mit transparentem grauem Schirm und grauem Textilkabel. Auch in opalweißem Glas mit silbernem Kabeln erhältlich.





Q.Bo

Carlos Serra / Antonio Herrero



 Fluor. 18W (GX24 d-2)

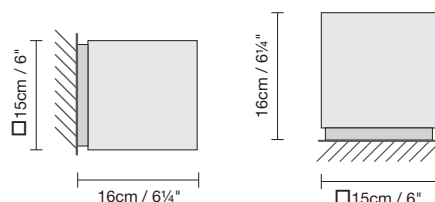

Luminaria de mesa, plafón y aplique con difusor de policarbonato y equipo electrónico.
Acabados: Nuevo acabado con base pintada en blanco mate. También disponible en gris.

Table, ceiling and wall lamp with a polycarbonate diffuser and electronic equipment.

Finishes: New finishes, with a matte white painted base. Also available in grey.

Tisch-, Decken- und Wandleuchte mit Polykarbonatdiffusor und elektrischer Ausstattung.

Ausführungen: Neue Ausführung mit matt-weiß gestrichener Basis. Auch in Grau verfügbar.





Boletus

Jorge Pensi



 Fluor. 20W (E27)

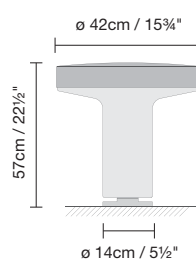

Luminaria de mesa de estructura en cristal tríplex y reflector metálico lacado. **Acabados:** Nuevo acabado con reflector en blanco o beige texturado mate y cable textil del mismo tono. También disponible en acabado níquel satin.

Table lamp with a triplex glass structure and lacquered metallic reflector. **Finishes:** New finish with reflector in white or textured matte beige, and a textile cable in the same tone. Also available in a satin nickel finish.

Tischleuchte mit Triplexglas-Struktur und lackiertem Metallreflektor. Ausführungen: Neue Ausführung mit weißem oder beigeem Reflektor, matt texturiert, und Textilkabel in derselben Farbe. Auch erhältlich mit satinierter Nickeloberfläche.



Ronda

Jorge Pensi

Familia de luminarias compuesta por las funciones de mesa, pie, suspensión y plafón, de estructura metálica y pantalla de madera curvada.
Acabados: Nuevo acabado en blanco mate. También disponible en acabado gris claro con pantalla de madera de roble natural, o wengué.

A line of lamps covering table, floor, suspension and ceiling functions, with a metallic structure and curved wooden shade.

Finishes: New finish in matte white. Also available in light grey with a natural oak or wenge shade.

Leuchtenfamilie mit Varianten als Tisch-, Steh-, Hänge- und Deckenleuchte. Metallstruktur, Schirm aus gebogenem Holz.

Ausführungen: Neue Ausführung in mattem Weiß. Auch erhältlich in der Ausführung Hellgrau mit Eichenholzschirm natur oder Wengué.



Fluor. circ. 40W (2Gx13)

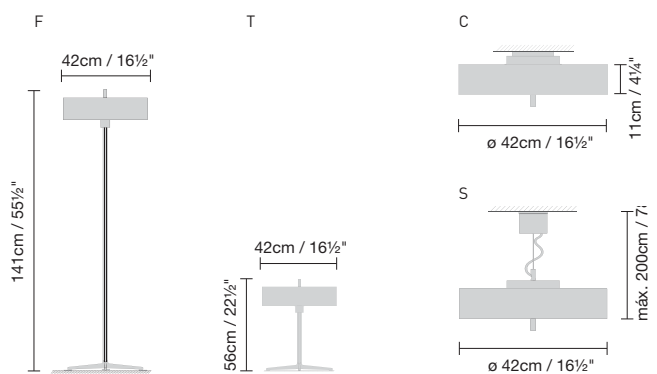



Olsen

Jorge Pensi

 Fluor. circ. 60W [2Gx13]

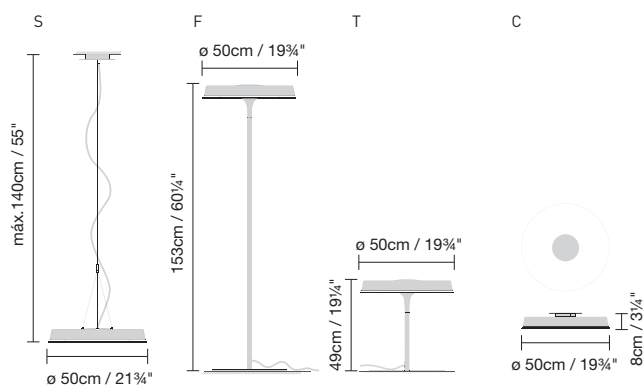

Familia de luminarias de mesa, pie, suspensión y plafón fabricada en aluminio y difusor blanco opal.

Acabados: Nuevo acabado en negro mate texturado con cable textil negro. También disponible en blanco mate texturado con cable textil blanco.

A line of table, floor, suspension and ceiling lamps crafted in aluminium, with an opal white diffuser.

Finishes: New finish in texturized matte black, with a black textile cable. Also available in texturized matte white with a white textile cable.

Leuchtenfamilie mit Varianten als Tisch-, Steh-, Hänge- und Deckenleuchte aus Aluminium mit opalweißem Diffusor.

Ausführungen: Neue Ausführung in Schwarz matt und texturiert mit schwarzem Textilkabel. Auch erhältlich in Weiß matt und texturiert mit weißem Textilkabel.



Luminaria de mesa o aplique con dos posiciones y estructura metálica. Luz orientable.

Acabados: Nuevo acabado en blanco mate texturado con cable blanco. También disponible en gris metalizado.

Table or wall lamp featuring two positions and a metallic structure. Adjustable light.

Finishes: New finish in texturized matte white, with a white cable. Also available in metallised grey.

Tisch- oder Wandleuchte mit zwei Positionen und Metallstruktur. Ausrichtbares Licht.

Ausführungen: Neue Ausführung in Weiß matt und texturiert mit weißem Kabel. Auch in Graumetallic verfügbar.

LED 7,35W 3000K 896 lm

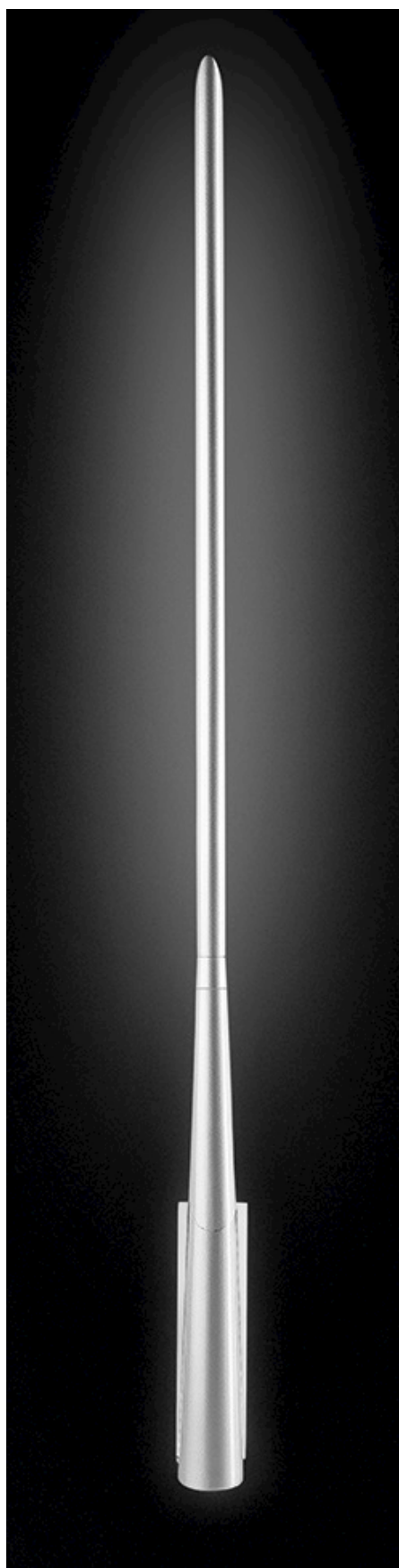
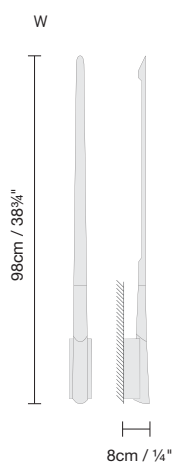
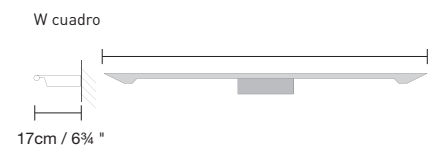
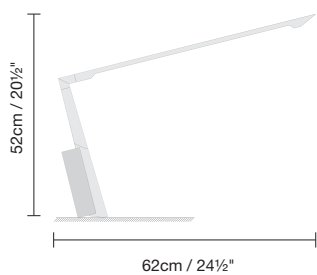
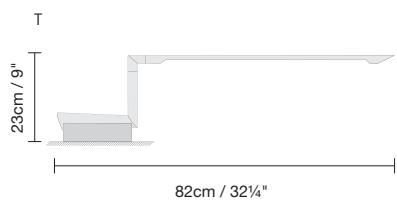

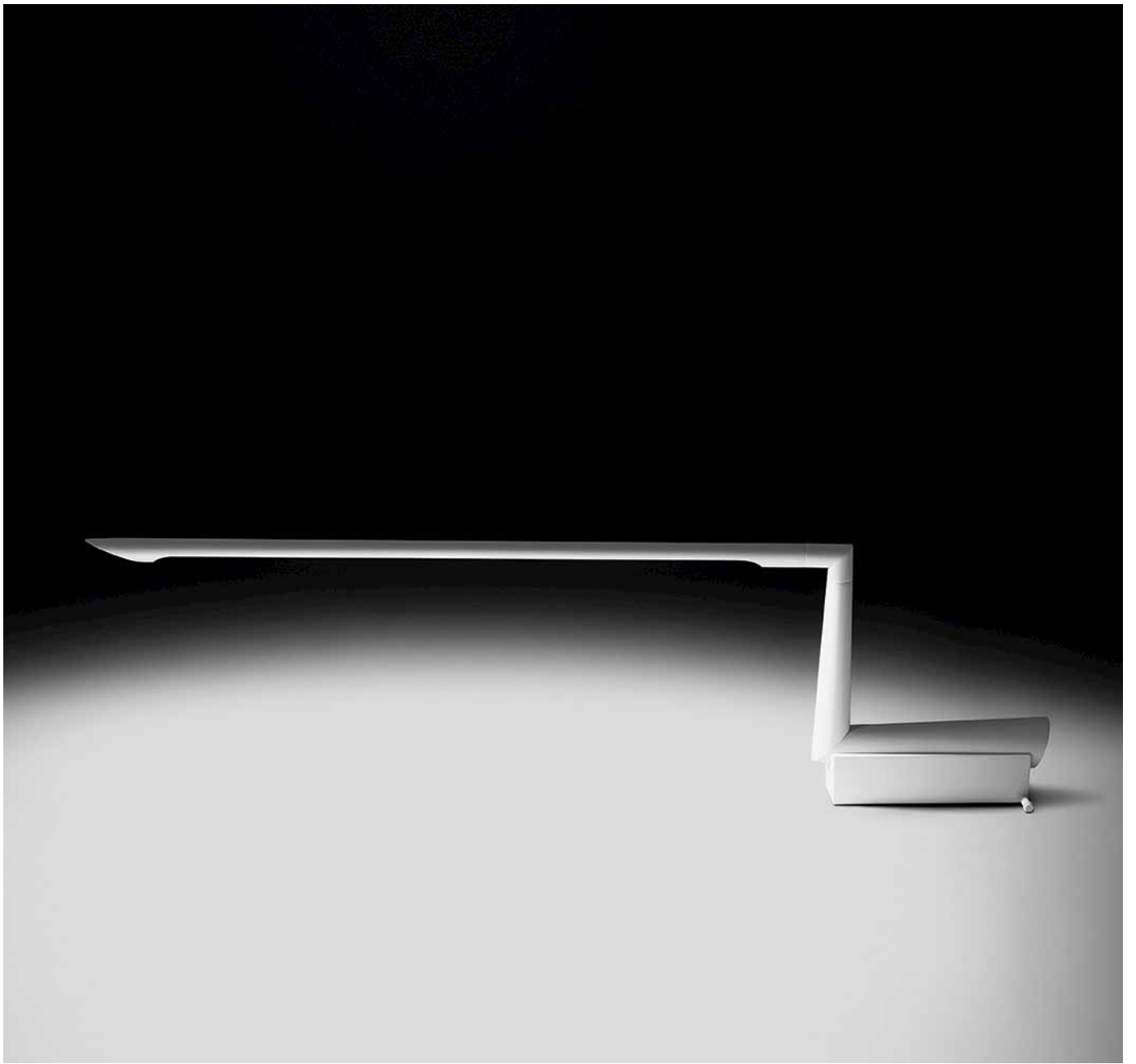

Eliana

Manel Ybargüengoitia

Luminaria de suspensión de luz directa.

Acabados: Nuevo acabado en madera de roble, con cable textil marrón. También disponible en acabado cromo mate con cable textil rojo, plata o negro, y acabado bronce con cable negro.

Direct light suspension lamp.

Finishes: New finish in oak, with brown textile cable. Also available in matte chrome finish with a textile cable in red, silver, or black, or a bronze finish with a black cable.

Hängeleuchte für direkte Beleuchtung.

Ausführungen: Neue Ausführung in Eichenholz mit braunem Textilkabel. Auch verfügbar in den Ausführungen matt verchromt mit rotem, silbernem oder schwarzem Textilkabel, oder in Bronze mit schwarzem Kabel.



◇ G125 máx. 70W (E27) Reflector
o Lámpara vintage de filamento 60W (E27)
o G125 Halóg. Clara 18W (E27)

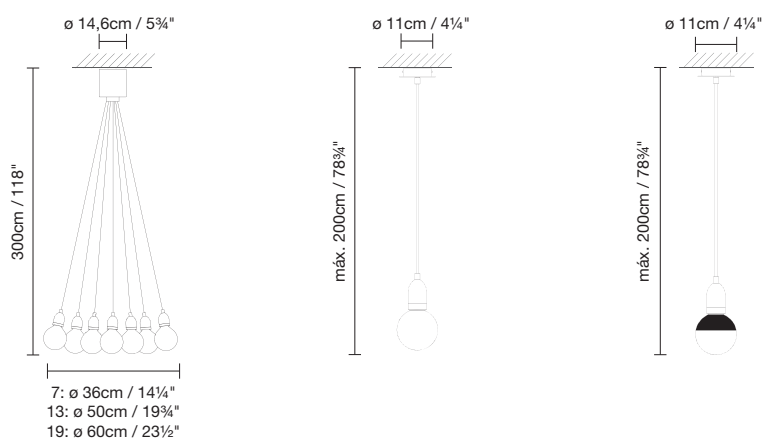



Ilde Wood

David Abad

Centra

Halóg. PAR30 75W (E27)
Inc. 60W (E27)

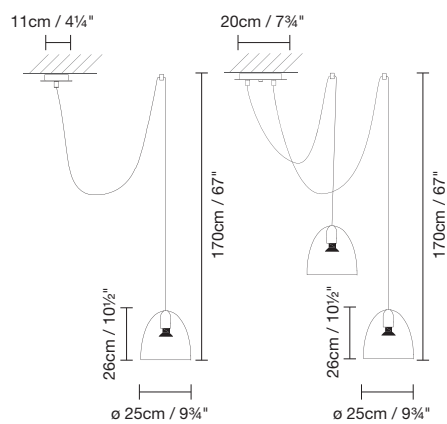

Minicentra

Halóg. PAR16 50W (Gu10)
Inc. 60W (E27)

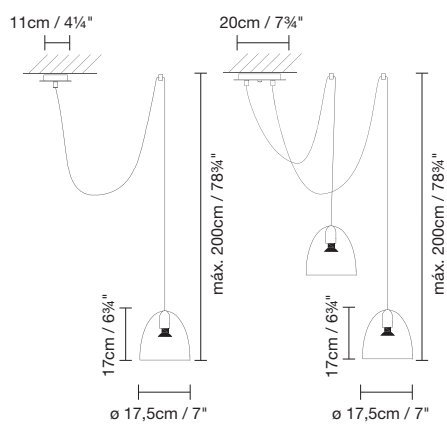

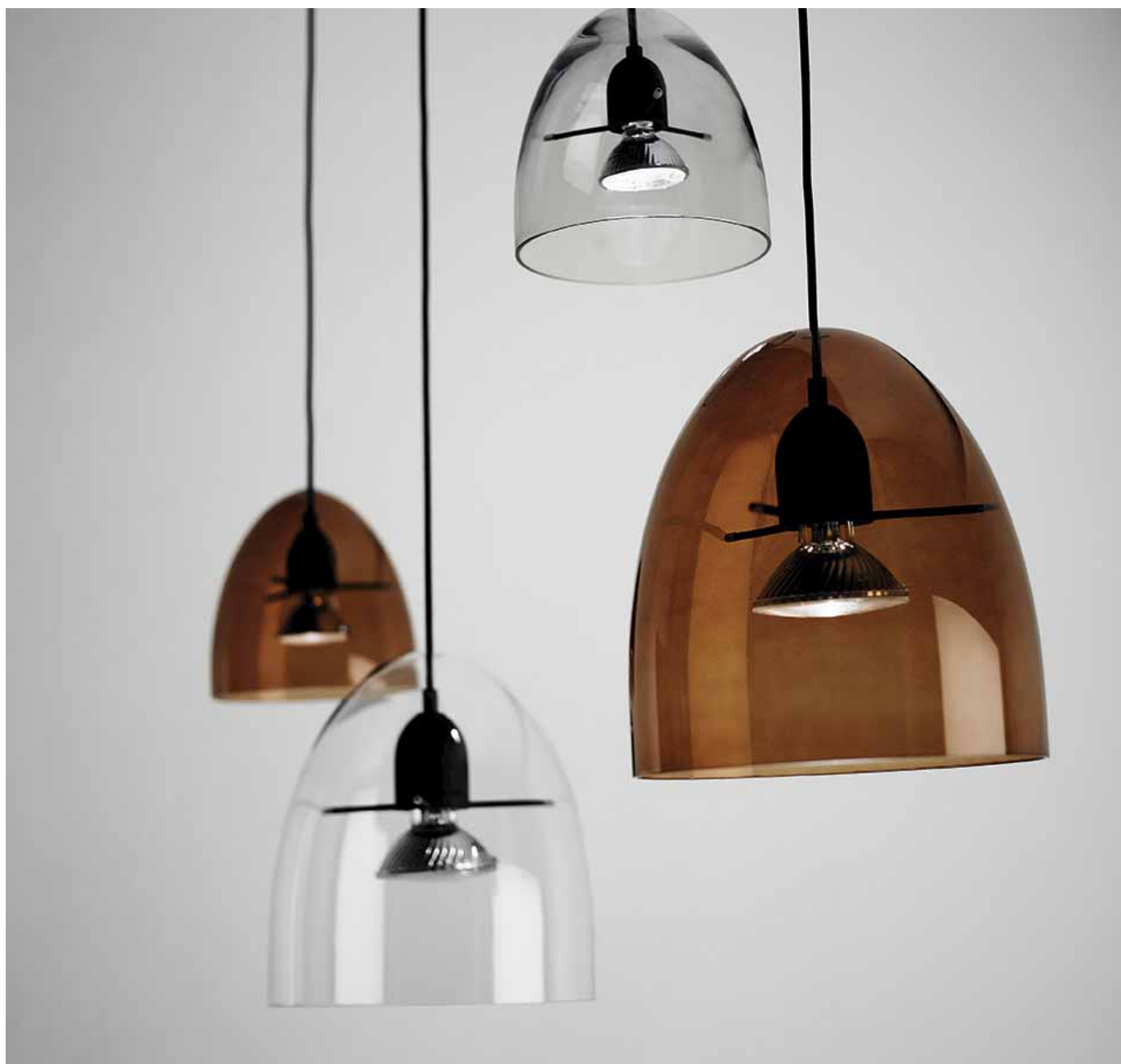

Centra / Minicentra

David Abad



Luminaria de suspensión de estructura metálica y pantalla de cristal soplado. Luz directa.

Acabados: Nuevo acabado pantalla gris, coñac transparente. También disponible con pantalla de cristal transparente.

Suspension lamp with a metallic structure and blown-glass shade and direct light.

Finishes: New finish in transparent cognac or gray. Also available in transparent glass shade.

Hängeleuchte mit Metallstruktur und Schirm aus geblasenem Glas. Direkte Beleuchtung.

Ausführungen: Neue Ausführung mit transparentem grauem Schirm und grauem Silikonkabel. Auch mit transparentem Glasschirm erhältlich.

Petite

T/W21: Halog. classic máx. 46W (E14)
T/W22: Halog. classic máx. 57W (E27)

T/W11: Halog. classic máx. 46W (E14)
T/W12: Halog. classic máx. 57W (E27)

P22: Halog. classic max. 52W (E27)
P12: Halog. classic max. 52W (E27)

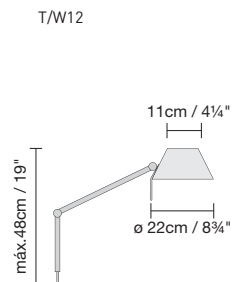
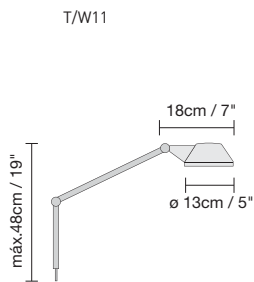
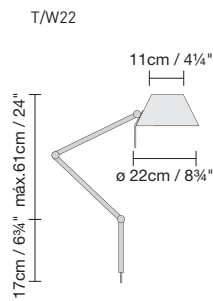
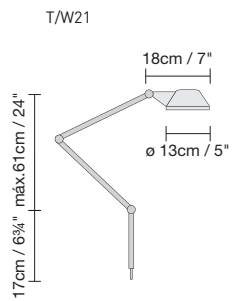
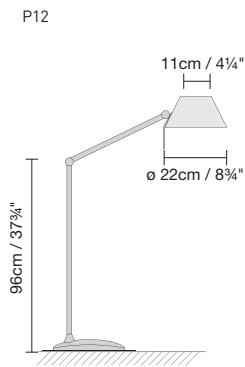
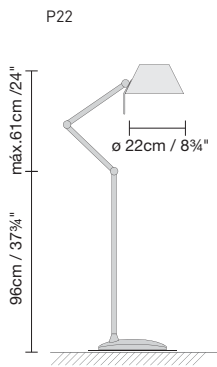

Petite Led

T1: LED 5 X 2,27w 700 mA 750 lm 3000K

T2: LED 5 X 2,27w 700 mA 750 lm 3000K

F: LED 5 X 2,27w 700 mA 750 lm 3000K

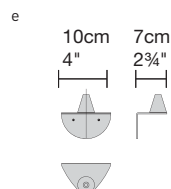
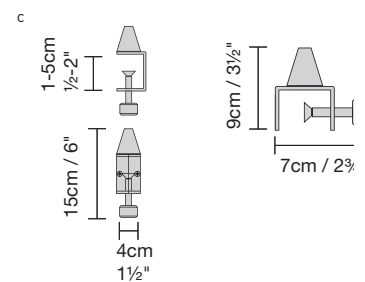
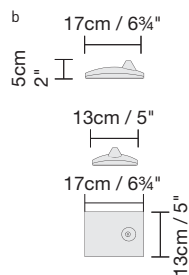
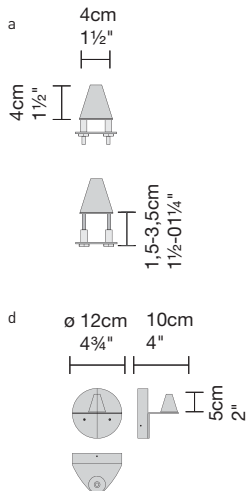
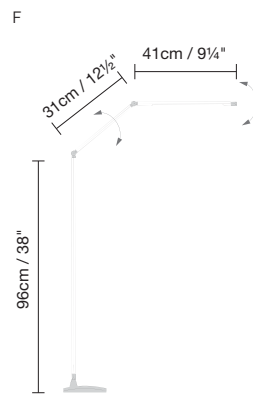
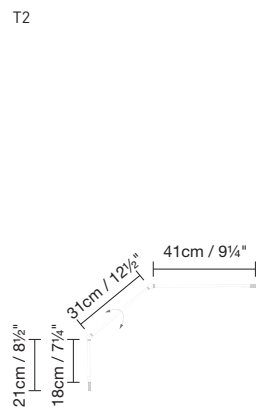
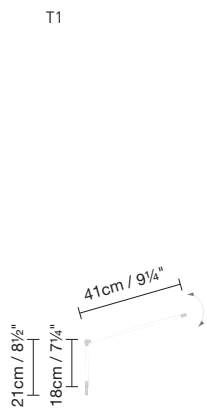



Petite / Petite Led

Miguel Herranz



Familia de luminarias de mesa, pie y aplique, articuladas y orientables, de estructura metálica.

Acabados: Blanco mate, gris mate, y anodizado brillo.

A line of table, floor and wall lamps, articulated and adjustable, with metallic structures.

Finishes: Matte white, matte grey, and anodized gloss.

Mit Gelenken verstellbare Leuchtenfamilie mit Varianten als Tisch-, Steh- und Wandleuchte. Metallstruktur.

Ausführungen: Weiß matt, Grau matt und glänzend anodisiert.



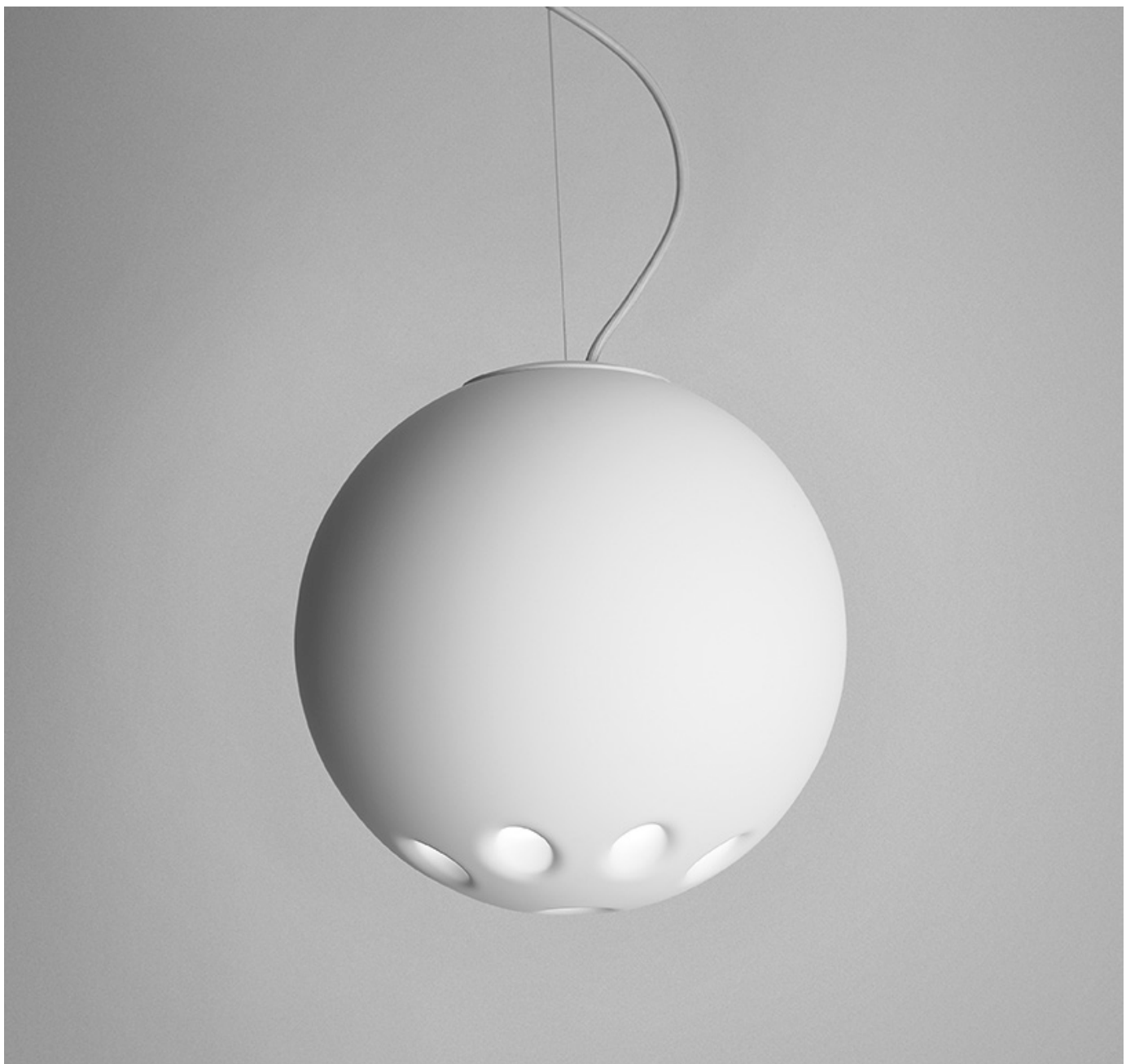

Round White

Marco Bisenzi

 S1-40: LED 9 x 3W 900 mA Dimmer 1690 lm 3000K
 S1-50: LED 15 x 3W 900 mA Dimmer 2800 lm 3000K

Luminaria de suspensión de policarbonato y forma esférica, con lámparas LED. Disponible en dos tamaños.

Acabados: Nuevo acabado en blanco mate texturado, con cable textil blanco. También disponible en acabado espejo y cable textil plata o rojo.

Polycarbonate suspension lamp with a spherical shape, and hed hight. Available in two sizes.

Finishes: New finish matte white, with a white textile cable . Also available in a mirror finish and a silver or red textile cable.

Kugelförmige Hängeleuchte mit LEDs, hergestellt aus transparentem Polykarbonat. Lieferbar in zwei Größen.

Ausführungen: Neue Ausführung in Weiß matt und texturiert mit weißem Textilkabel. Auch verfügbar als verspiegelte Ausführung mit Textilkabel in Silber oder Rot.

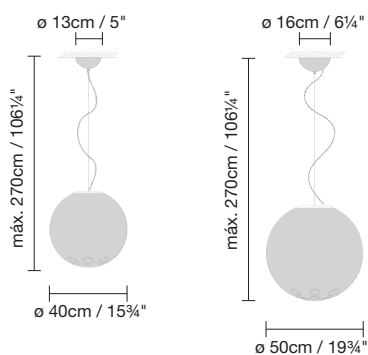



Helios

Manel Ybargüengoitia

- 60: Halóg. classic 7 x máx. 60W (E14)
- 90: Halóg. classic 7 x máx. 100W (E27)

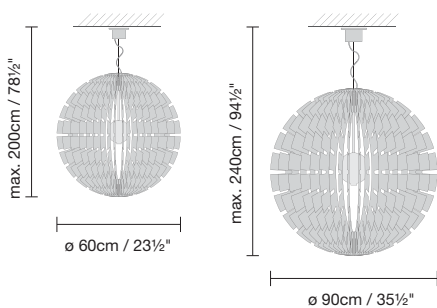

Luminaria de suspensión de estructura metálica o madera.
Acabados: Nuevo acabado en blanco texturado con cable blanco.
 También disponible en gris mate con cable transparente, o en madera con cable plata (solo Helios 60).

Suspension lamp featuring a metallic or wooden structure.
Finishes: New finish in texturized white, with a white cable.
 Also available in grey matte with a transparent cable, or in wood with a silver cable (only Helios 60).

Hängeleuchte, Struktur aus Metall und Holz.
Ausführungen: Neue Ausführung in texturiertem Weiß und mit weißem Kabel. Auch erhältlich in matt Grau mit transparentem Kabel oder in Holz mit silbernem Kabel (nur Helios 60).





Roof C/W

David Abad

CI/WI 70: Fluor. 14/24W (G5)
 CI/WI 130: Fluor. 28/54W (G5)
 CI/WI 160: Fluor. 35/49W (G5)

CII/WII 70: Fluor. 2 x 14/24W (G5)
 CII/WII 130: Fluor. 2 x 28/54W (G5)
 CII/WII 160: Fluor. 2 x 35/49W (G5)

Plafón o aplique individual o doble de aluminio, con difusor de cristal transparente y luz difusa.

Acabados: nuevo acabado blanco mate. También disponible en aluminio satinado.

Single or double wall or ceiling lamp made from aluminium, with a transparent glass shade and diffuse light.

Finishes: new finish in matte white. Also available in satin aluminium.

Einzel oder paarweise installierte Wand- und Deckenleuchte, jeweils mit transparentem Glasdiffusor für Streulicht.

Ausführungen: Neue Ausführung in mattem Weiß. Auch in satines Aluminium verfügbar.

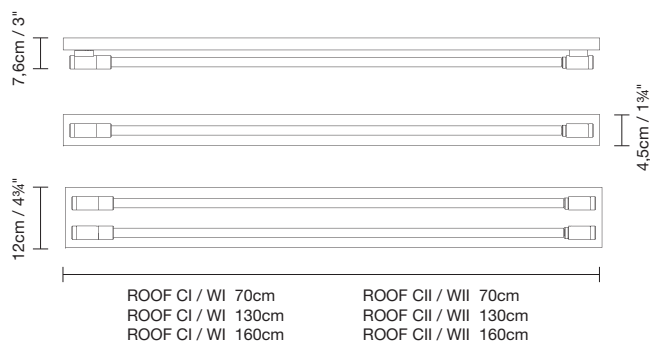



Roof S

David Abad

 S130: Fluor. 28/54W (G5)
 S160: Fluor. 35/49W (G5)

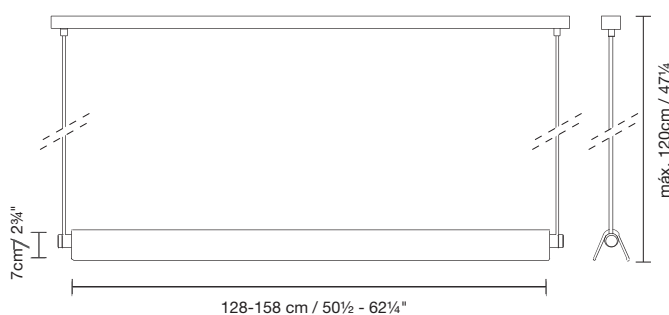

Luminaria de suspensión fabricada en aluminio. Luz directa.
Accesorios: reflector de lamas de aluminio brillo, pantalla reflectora de aluminio, o de metacrilato.
Nuevo acabado: blanco mate con pantalla reflectora laminada en madera de roble.

Suspension lamp made from aluminium. Direct light.
Accessories: gloss aluminium reflector panel, reflective aluminium shade or reflective methacrylate shade.
Finishes: new finish in matte white with an oak veneer reflective shade.

Hängeleuchte aus Aluminium. Direkte Beleuchtung.
Unwesentlich: Aluminiumlamellen Reflektor, Reflektorschirm oder ans Methacrylat.
Ausführungen: Neue Ausführung Weiss matt mit Eiche natur Reflektorschirm.



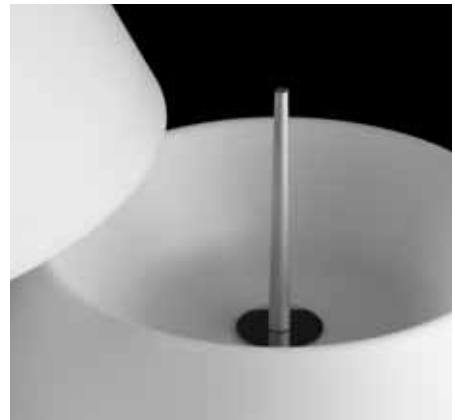
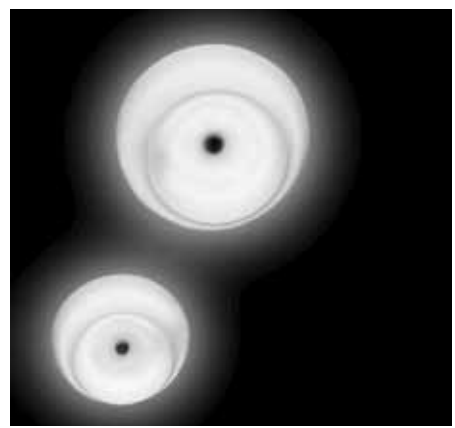

Julia & Julieta

Manel Ybargüengoitia

Julia: Fluor. circ. 55W [2Gx13]
 Julieta: Fluor. circ. 22W [2Gx13]

Familia de luminarias de mesa, plafón y aplique de estructura metálica y difusor de metacrilato blanco mate que oculta la fuente de luz.

Acabados: Nuevo acabado en blanco mate texturado. También disponible en acabado gris.

A line of table, ceiling and wall lamps with metallic structures and a matte white methacrylate diffuser that conceals the light source.
Finishes: New finish in texturized matte white. Also available in a grey finish.

Leuchtenfamilie mit Varianten als Tisch-, Decken- und Wandleuchte, Metallstruktur, der matt-weiße Methacrylat-Diffusor verbirgt die Lichtquelle.

Ausführungen: Neue Ausführung in mattem, texturiertem Weiß. Auch in Grau verfügbar.

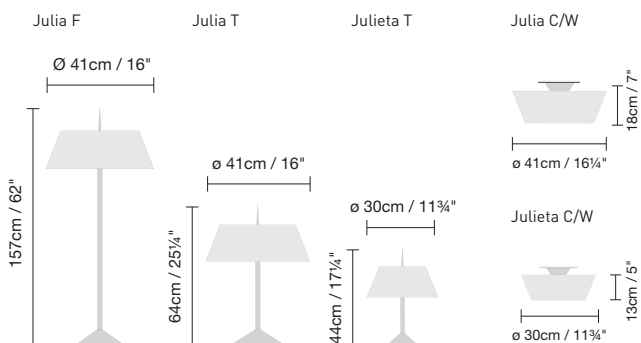

TECH

Anvil System
Deep Cove System
Deep System
Deep R

La personalización se ha convertido en un punto diferenciador que contribuye a satisfacer las necesidades de ejecución de proyectos arquitectónicos exclusivos. B.lux cuenta con una gama de sistemas de perfiles equipados con las más eficientes fuentes de luz, así como luminarias técnicas y estándar, que unidas a su capacidad de ejecución productiva, ofrecen un servicio personalizado, indispensable para el desarrollo de los proyectos más exigentes.

Customization has become a distinguishing factor serving to meet the needs of unique architectural projects. B.lux boasts a range of profile systems equipped with the most efficient light sources, as well as technical and standard lamps which, along with their unique productive capacity, offer customized service, indispensable to meet the requirements of the most demanding projects.

Die individuelle Anpassung von Designs und Systemen ist zu einem wichtigen Differenzierungsfaktor geworden, um bei der Umsetzung exklusiver architektonischer Projekte die konkreten Anforderungen zu erfüllen. B.lux bietet ein breites Sortiment von Schienen, ausgestattet mit effizientesten Leuchten. Dazu kommen die technischen Leuchten und Standardmodelle, die dank spezifischer Produktionskapazitäten den individuellen Wünschen entsprechend gefertigt werden können. Ein Service, der für die Entwicklung der anspruchsvollsten Projekte unverzichtbar ist.

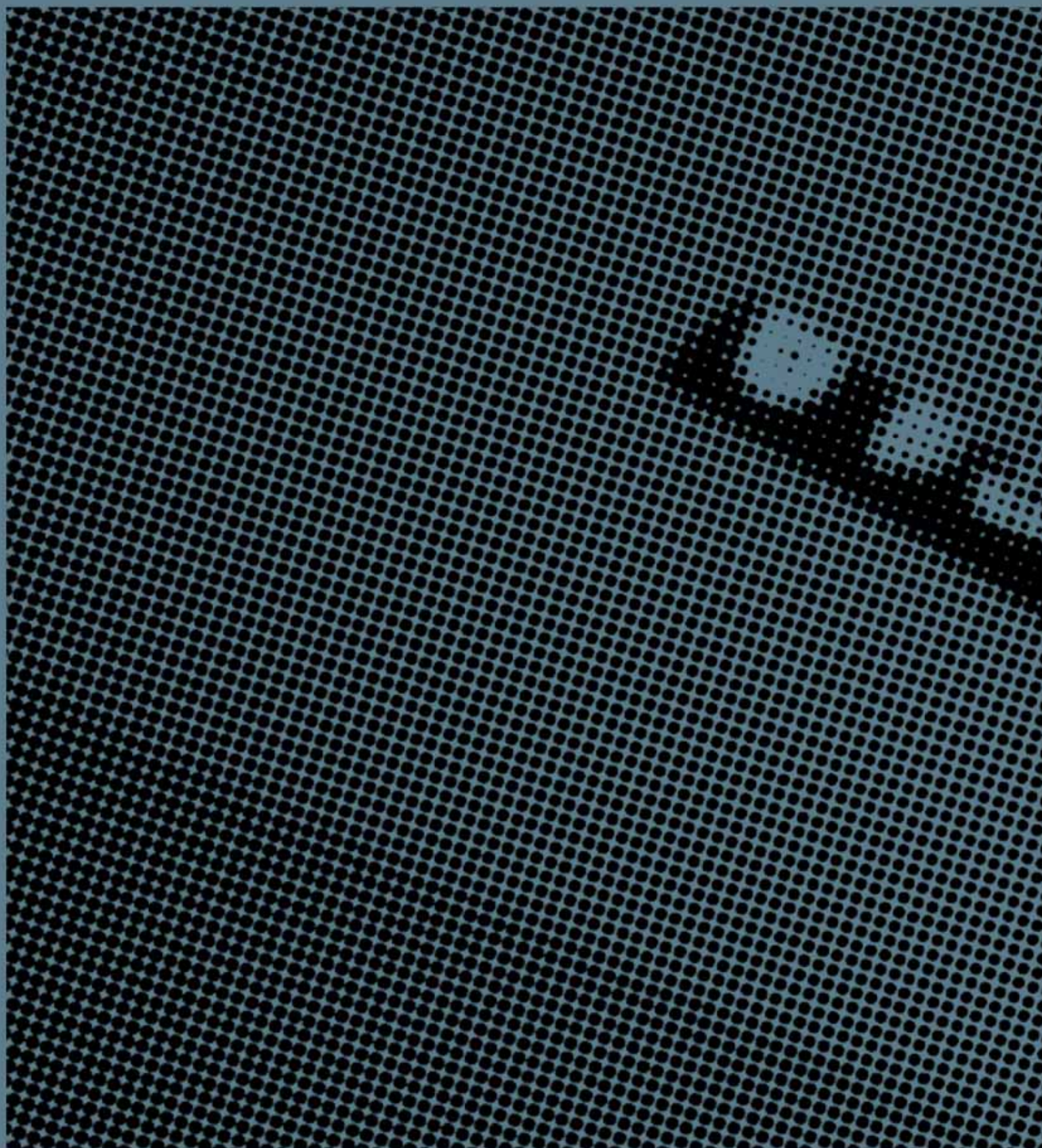

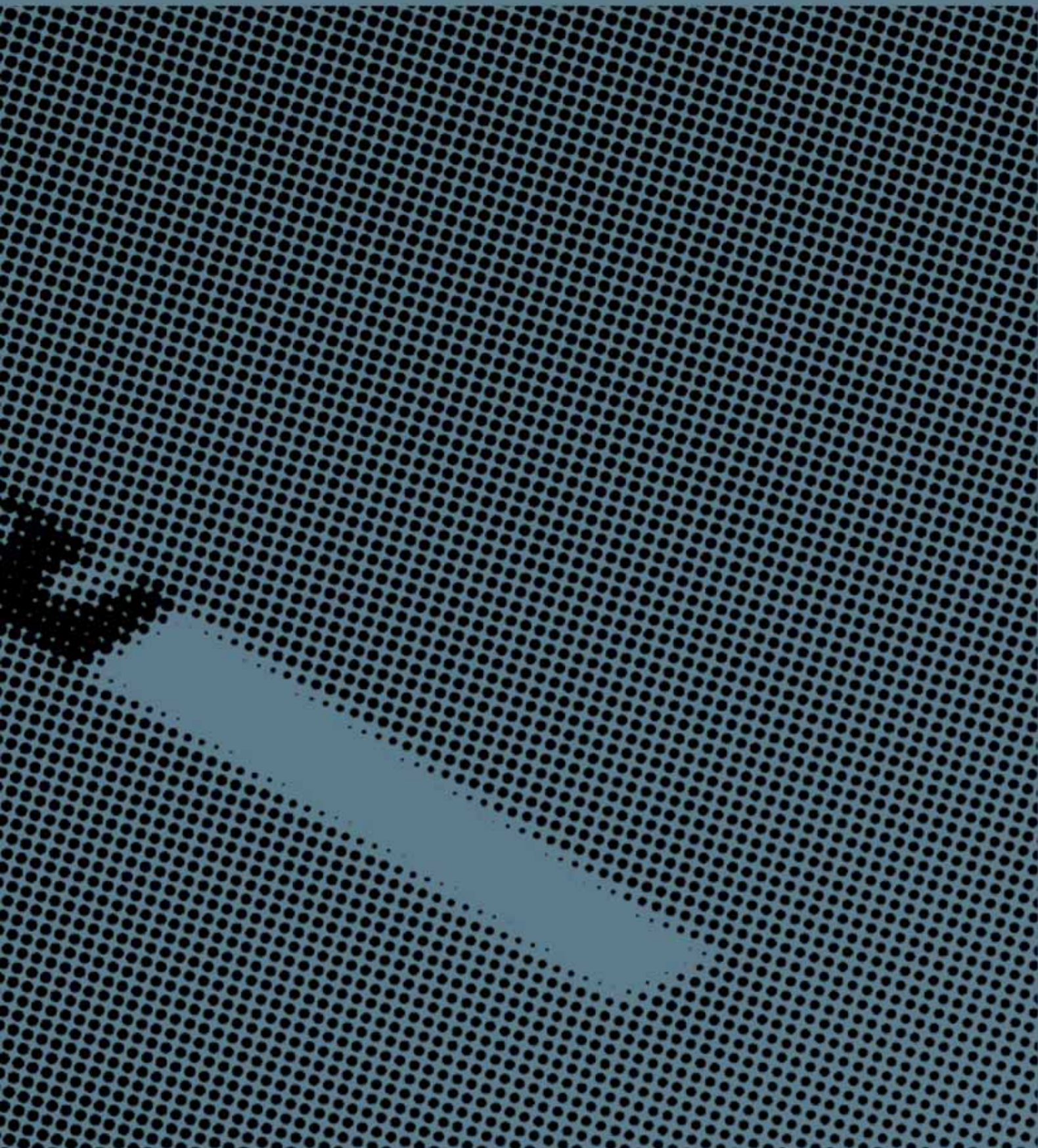



Anvil System

David Abad



Sistema de iluminación fluorescente de luz continua seamless o módulos LED. Fabricado en aluminio extruido.

Acabados: Blanco o negro, mate.

Continuous fluorescent lighting system; seamless or LED modules. Manufactured in extruded aluminium.

Finishes: White or black, matte.

Durchgehendes Seamless-Beleuchtungssystem mit Leuchtstoffröhren oder LED-Module. Gefertigt aus extrudiertem Aluminium.

Ausführungen: Weiß oder Schwarz, Matt.



C90/S90: Fluor. 14-24W (G5) seamless
 C120/S120: Fluor. 21-39W (G5) seamless

C180/S180: Fluor. 28-54W (G5) seamless
 C240/S240: Fluor. 35-49-80W (G5) seamless

LED 25,6W 2520 lm 3000K CRI 80

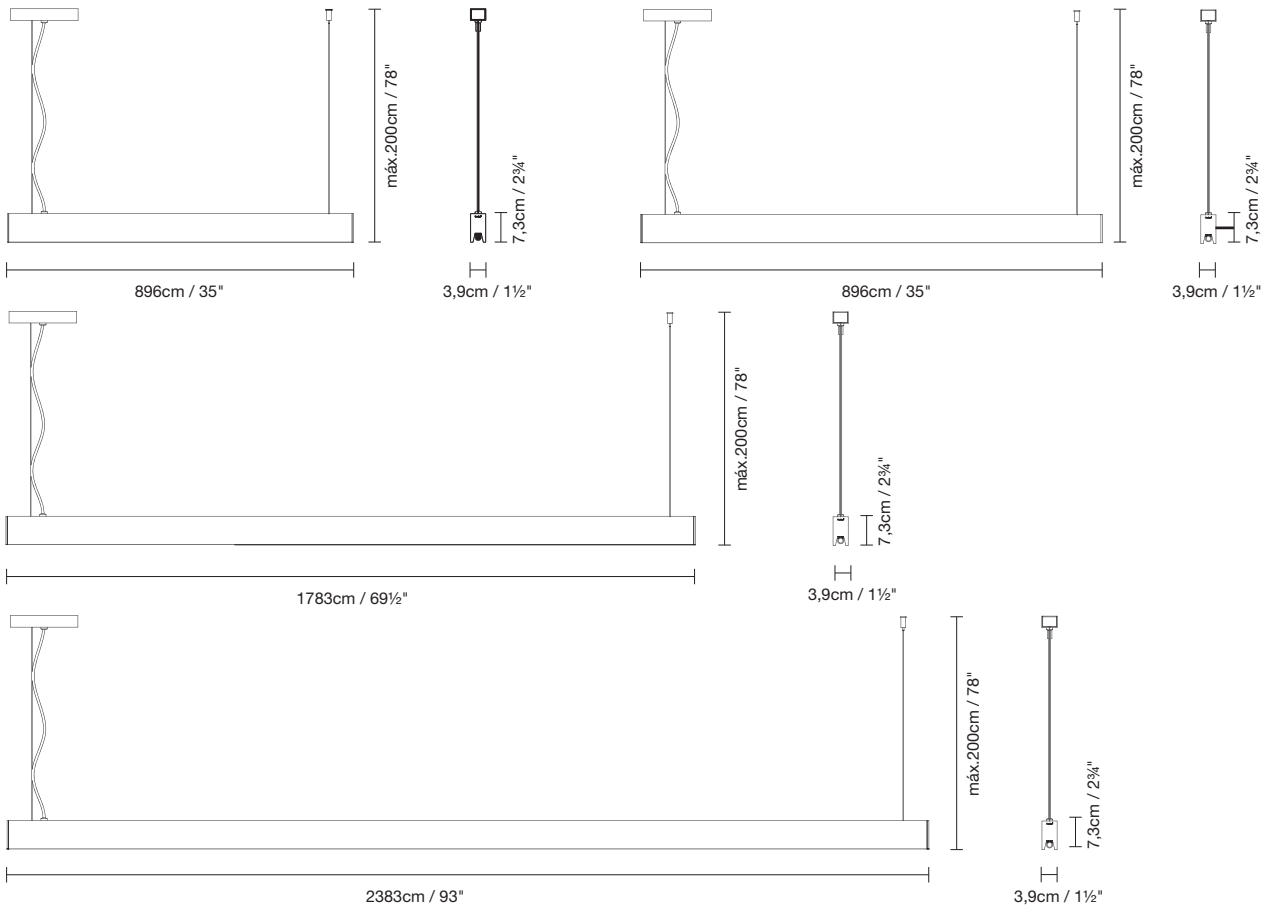

PERFILES STANDARD

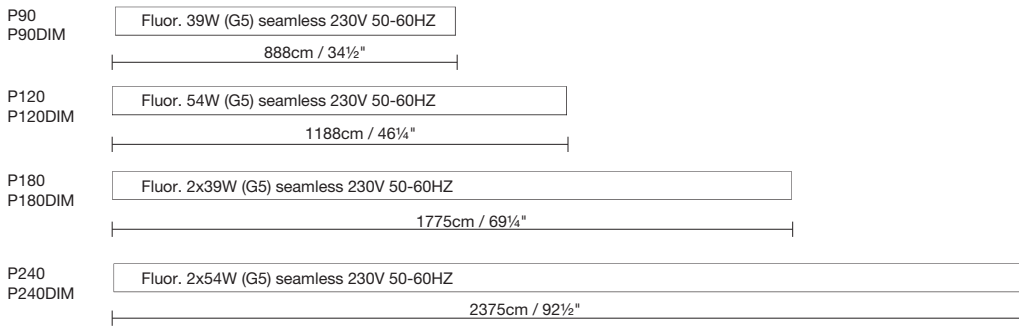

PERFILES A MEDIDA

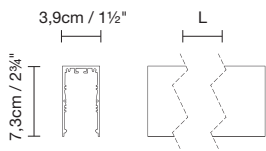

ANGULOS ANVIL

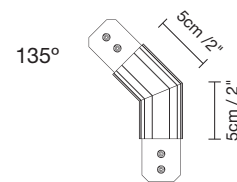
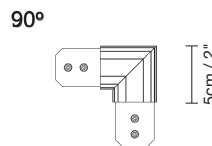
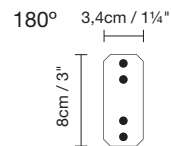



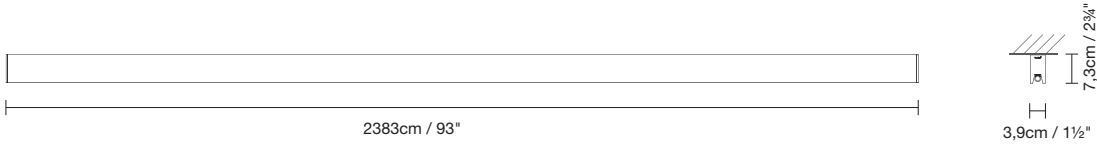
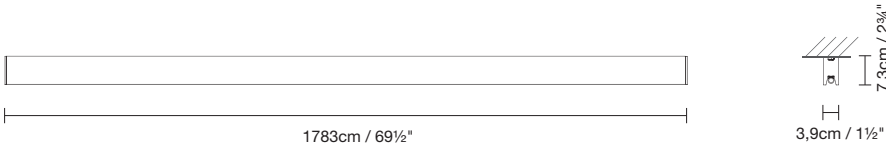
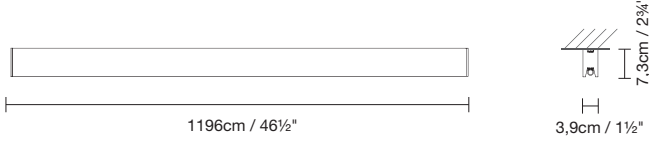
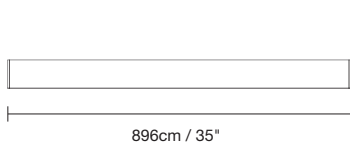

ANVIL CONSTRUYE

*Ejemplo fluorescente

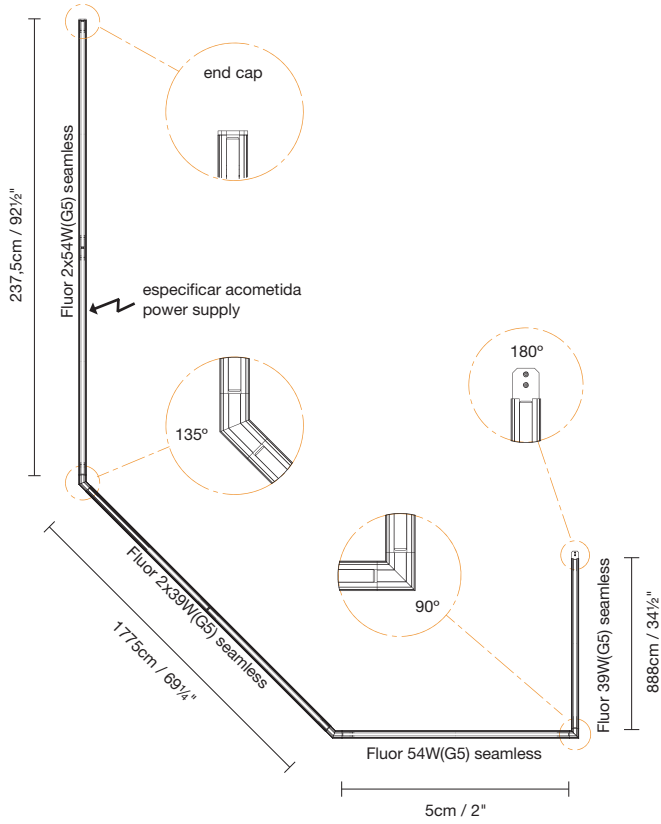

*Ejemplo Led

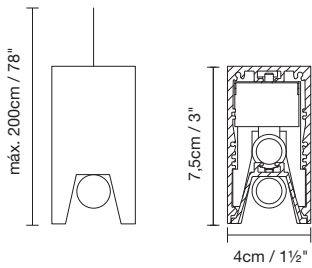
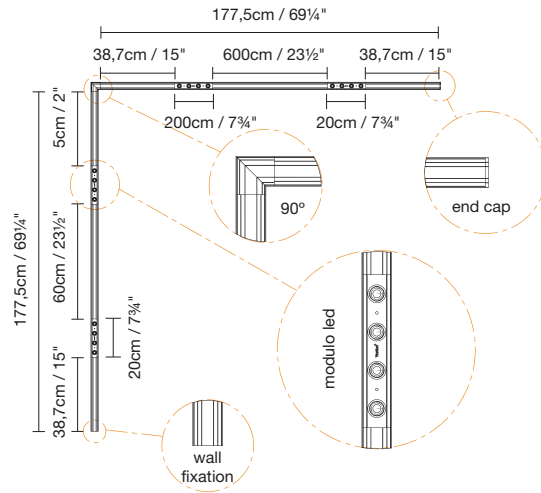



Sistema de iluminación trimless de perfilera de aluminio extruido, específicamente concebido para conseguir efectos cornisa y espacios perimetrales retroiluminados trimless, con posibilidad de instalar proyectores ocultos, o ambos. Asimismo, permite la instalación de carril trifásico universal para la incorporación de proyectores Deep con adaptador. Óptima iluminación, totalmente invisible desde cualquier ángulo. Permite múltiples aplicaciones. Fácil instalación. Deep Cove System se fabrica ajustándose al proyecto del cliente.

Acabados: Aluminio natural para integrar en el acabado de la arquitectura. Otros acabados, consultar.

Trimless lighting system featuring an extruded aluminium profile specifically designed to achieve cornice effects and trimless backlit perimeter spaces, with the capacity to install hidden projectors, or both. It also makes possible the installation of universal three-phase tracks for the incorporation of Deep projectors with an adapter. Optimum lighting, completely invisible from any angle. Features multiple applications. Easy installation. Deep Cove System is custom-made according to the customer's specifications.

Finishes: Natural aluminium, for integration into the architecture's finish. Inquire about other finishes.

Eingelassenes Trimless-Beleuchtungssystem mit Schienen aus extrudiertem Aluminium, speziell entwickelt für Gesimse und eine nahtlose, umlaufende Ausleuchtung von Räumen. Strahler lassen sich verborgen installieren oder mit sichtbaren Strahlern kombinieren. Ermöglicht die Installation einer Universal-Dreiphasenschiene, um Strahler des Modells Deep mit Adapter zu integrieren. Optimale Beleuchtung, die aus jedem Winkel unsichtbar bleibt. Erlaubt diverse Anwendungen. Einfache Installation. Deep Cove System wird nach den Vorgaben des Kunden speziell für sein Projekt angefertigt.

Ausführungen: Aluminium Natur, in die Verkleidungselemente der Architektur zu integrieren. Weitere Ausführungen auf Anfrage.

Fluor. (G5)
QR111 máx. 100W (G53)

CDM-R 111 70W (GX8,5)
LED AR-111 12W (G53)

LED SMD continuo 24,5W/m 3000K

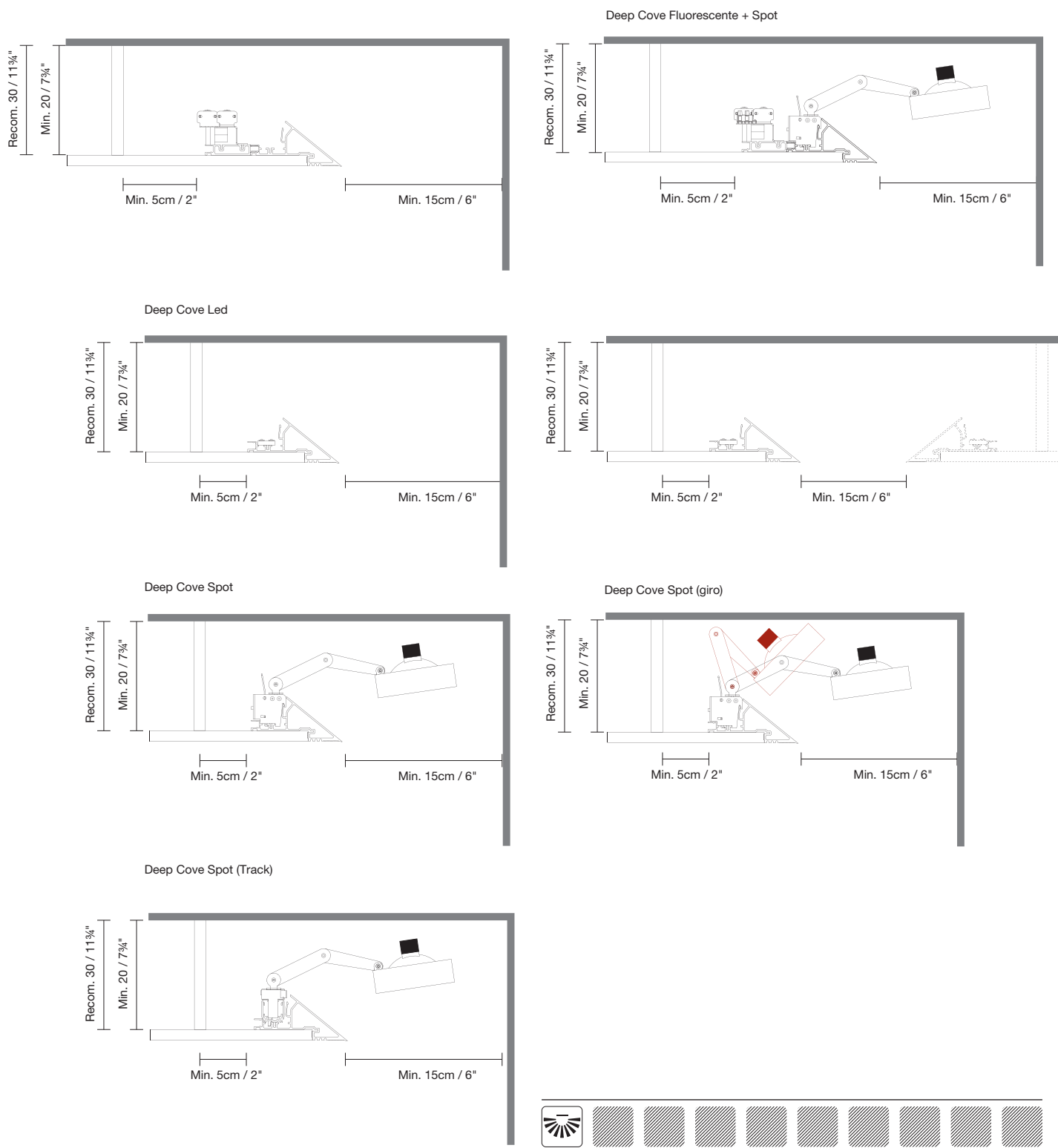



Deep Cove System

David Abad

ÁNGULOS DEEP COVE

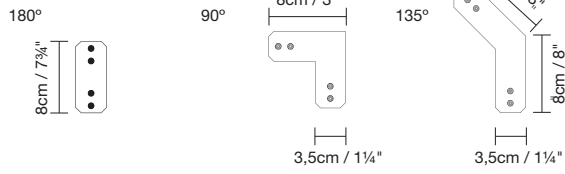

EJEMPLOS

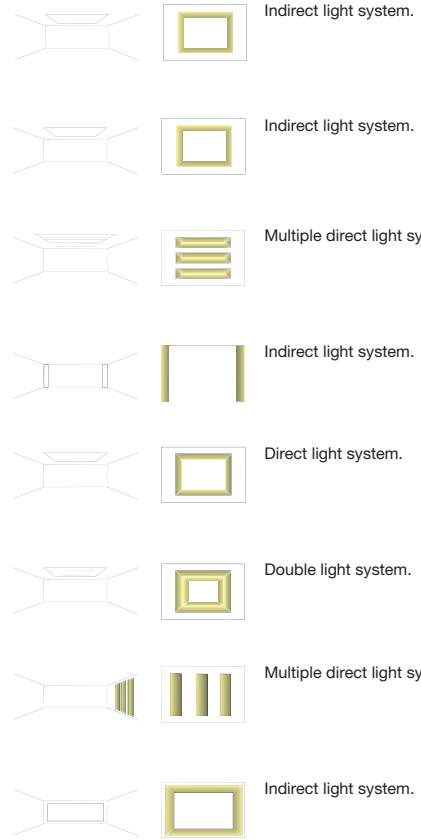
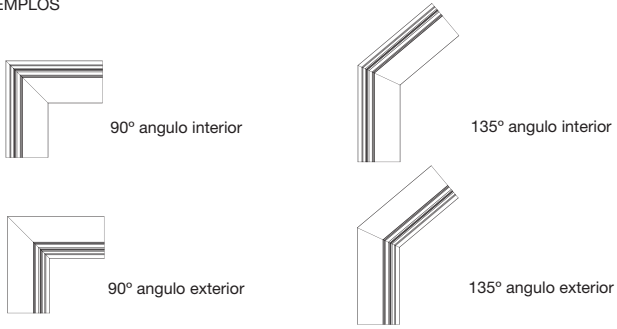

ACCESORIOS

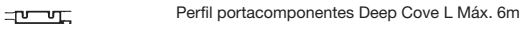

- Deep aro embellecedor QR-111
- Deep aro embellecedor + rejilla QR-111
- Deep aro embellecedor CDMR-111
- Deep aro embellecedor + rejilla CDMR-111

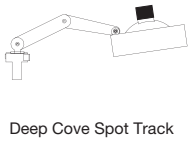

- Carril trifasico Global
- Carril trifasico Global control DALI

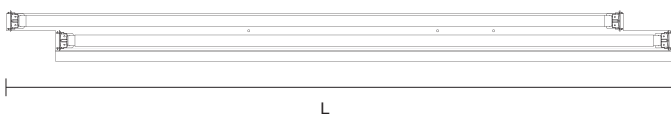
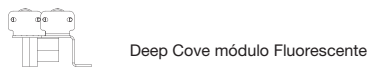

- 2x14/24W L: 70cm / 27 1/2"
- 2x21/39W L: 100cm / 39 1/4"
- 2x28/54W L: 130cm / 51 1/4"
- 2x35/80W L: 160cm / 63"



Sistema de iluminación trimless de perfilera de aluminio extruido para empotrar, que crea una abertura lineal y continua. Ofrece la posibilidad de instalar proyectores halógenos y halogenuros, así como proyectores LED o módulos de fluorescencia. Deep System incluye la posibilidad de incorporar carril trifásico. Sistema de difusores de climatización bajo consulta.

Acabados: Anodizado negro y pintura negro mate.

Trimless, recessed lighting systems featuring extruded aluminium profiles, creating a linear and continuous opening. It offers the possibility of installing halogen projectors and halides, as well as LED projectors or fluorescent modules. The Deep System includes the possibility of incorporating a three-phase track. Climate control diffuser system, upon request.

Finishes: Anodized black and matte black paint.

Eingelassenes Trimless-Beleuchtungssystem mit Schienen aus extrudiertem Aluminium, ebenfalls zum Einlassen. Sorgt für einen lineare, einheitliche Lichtwirkung. Ausgelegt für Strahler mit Halogenlampen und Metaldampf-Halogenlampen sowie LED-Strahler und Leuchtstoffmodule. Deep System bietet die Möglichkeit, eine Dreiphasenschiene zu integrieren. System für Klimaanlage-Belüftungsausgänge auf Anfrage.

Ausführungen: Schwarz anodisiert und mattschwarzer Anstrich.





Deep System

David Abad

Fluor. (G5)
QR111 máx. 100W (G53)

CDM-R 111 70W (GX8,5)
LED AR-111 12W (G53) o (Gu10)

Accesorios:

Deep Aro embellecedor
Deep Pantalla nido de abeja

Accessories:

Deep ring cover
Deep honeycomb screen

Zubehör:

Zierring Deep Aro
Bienenwaben-Schirm Deep Pantalla

Deep Spot:
LED 5W (Gu10)
HID 35W (GX10)
Halóg. 50W (Gu10)
QR111 máx. 100W (G53)
CDM-R 111 70W (GX8,5)
LED AR-111 12W (G53) o (Gu10)

Deep Spot:
LED 5W (Gu10)
HID 35W (GX10)
Halóg. 50W (Gu10)
QR111 máx. 100W (G53)
CDM-R 111 70W (GX8,5)
LED AR-111 12W (G53) o (Gu10)

Deep Spot:
LED 5W (Gu10)
HID 35W (GX10)
Halóg. 50W (Gu10)
QR111 máx. 100W (G53)
CDM-R 111 70W (GX8,5)
LED AR-111 12W (G53) o (Gu10)

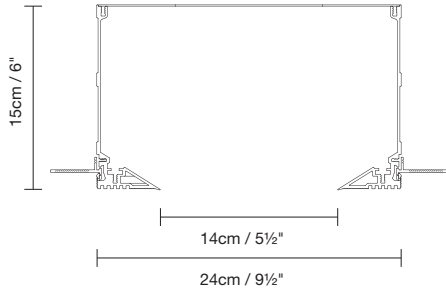

sección caja Deep System

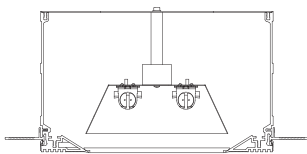
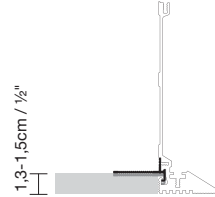

Deep System Fluorescente

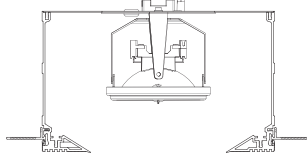

Deep System Cardan

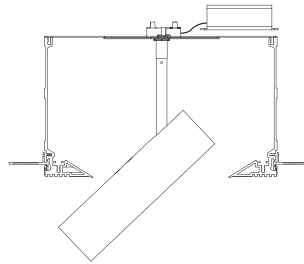

Deep System Spot 55

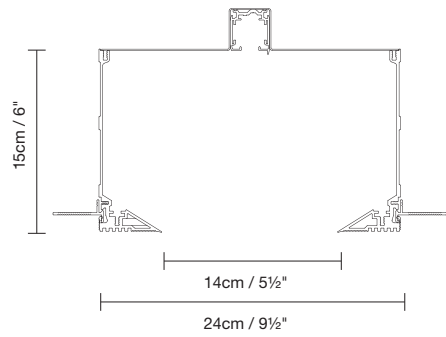

sección caja Deep Track System

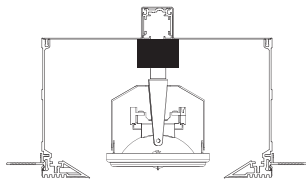

Deep System Cardan

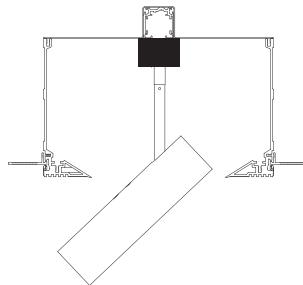

Deep System Spot 55

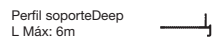

Herrajes

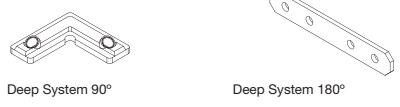

Fuentes de Luz

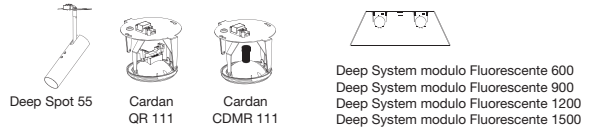

Tapas Superiores

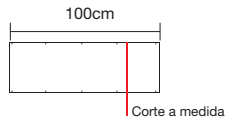
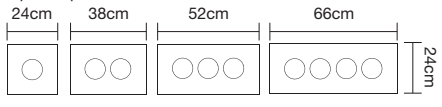

Tapas inferiores módulos Fluorescentes

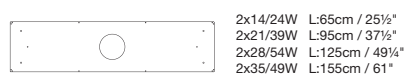

Tapa lateral para los módulos de Fluorescencia

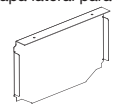

Conexión L

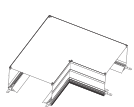

Conexión T

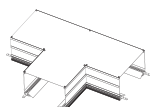

Conexión X

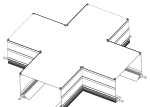



Deep R

David Abad

Fluor. (G5)
QR111 máx. 100W (G53)

CDM-R 111 70W (GX8,5)
LED AR-111 12W (G53) o (Gu10)

Luminarias empotrables trimless de perfilera de aluminio extruido, que crean una profundidad en el techo. Luz orientable y directa. Ofrece la posibilidad de instalar proyectores halógenos y halogenuros, así como proyectores LED o fluorescencia.

Acabados: Anodizado negro y pintura negra, o blanco mate.

Trimless, extruded aluminium profile lamps which create a sensation of depth in the ceiling. Adjustable and direct light. It offers the possibility of installing halogen projectors and halides, as well as LED projectors or fluorescence.

Finishes: Anodized black and black paint, or matte white.

Nahtlose Trimless-Einbauleuchten mit Schienen aus extrudiertem Aluminium. Schaffen Tiefenwirkung an der Decke. Ausrichtbare, direkte Beleuchtung. Ausgelegt für Strahler mit Halogenlampen und Metalldampf-Halogenlampen sowie LED- und Leuchtstoff-Strahler.

Ausführungen: Schwarz anodisiert und matt-schwarzer oder matt-weißer Anstrich.



Accesorios:
Deep Aro embellecedor
Deep Pantalla nido de abeja

Accessories:
Deep ring cover
Deep honeycomb screen

Zubehör:
Zierring Deep Aro
Bienenwaben-Schirm Deep
Pantalla

Deep Spot:
LED 5W (Gu10)
HID 35W (GX10)
Halóg. 50W (Gu10)
R25: Fluor. 13W (G24-q1)
R40: Fluor. 2 x 13W (G24-q1)

Deep Spot:
LED 5W (Gu10)
HID 35W (GX10)
Halóg. 50W (Gu10)
R25: Fluor. 13W (G24-q1)
R40: Fluor. 2 x 13W (G24-q1)

Deep Spot:
LED 5W (Gu10)
HID 35W (GX10)
Halóg. 50W (Gu10)
R25: Fluor. 13W (G24-q1)
R40: Fluor. 2 x 13W (G24-q1)

R25



R40

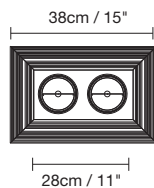

R55

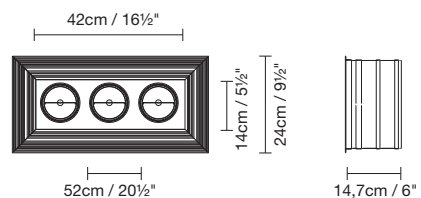

R70

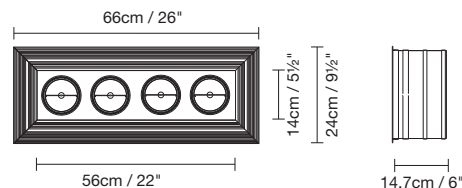

Outdoor

Magnet
Lap Bench
AMS
Frame
Junko
20/20

La iluminación de exterior se ha convertido en la clave para crear exteriores de gran personalidad. B.lux ofrece dos líneas de productos outdoor: luminarias decorativas de exterior para hogar, y otras, de carácter urbano. De diseño exclusivo, todas ellas están técnicamente resueltas para sobrevivir en el exterior y cuentan con la tecnología lumínica más avanzada.

Outdoor lighting has become the key to creating exteriors with real personality. B.lux offers two outdoor product lines: decorative outdoor lamps for the home, and others of an urban nature. With exclusive designs, all of them boast technical designs enabling them to weather outside conditions, and are equipped with the most advanced lighting technology.

Die Außenbeleuchtung hat bei der Gestaltung unverwechselbarer Außenbereiche eine zentrale Stellung eingenommen. B.lux bietet zwei Produktlinien für Außenbereiche: dekorative Außenleuchten für Wohnanwesen und solche für die Gestaltung urbaner Räume. Sie alle bieten exklusives Design und sind technisch so ausgereift und gestaltet, dass sie den spezifischen Bedingungen des Einsatzes im Freien bestens gewachsen sind. Ausgestattet sind sie mit fortschrittlichster Beleuchtungstechnologie.

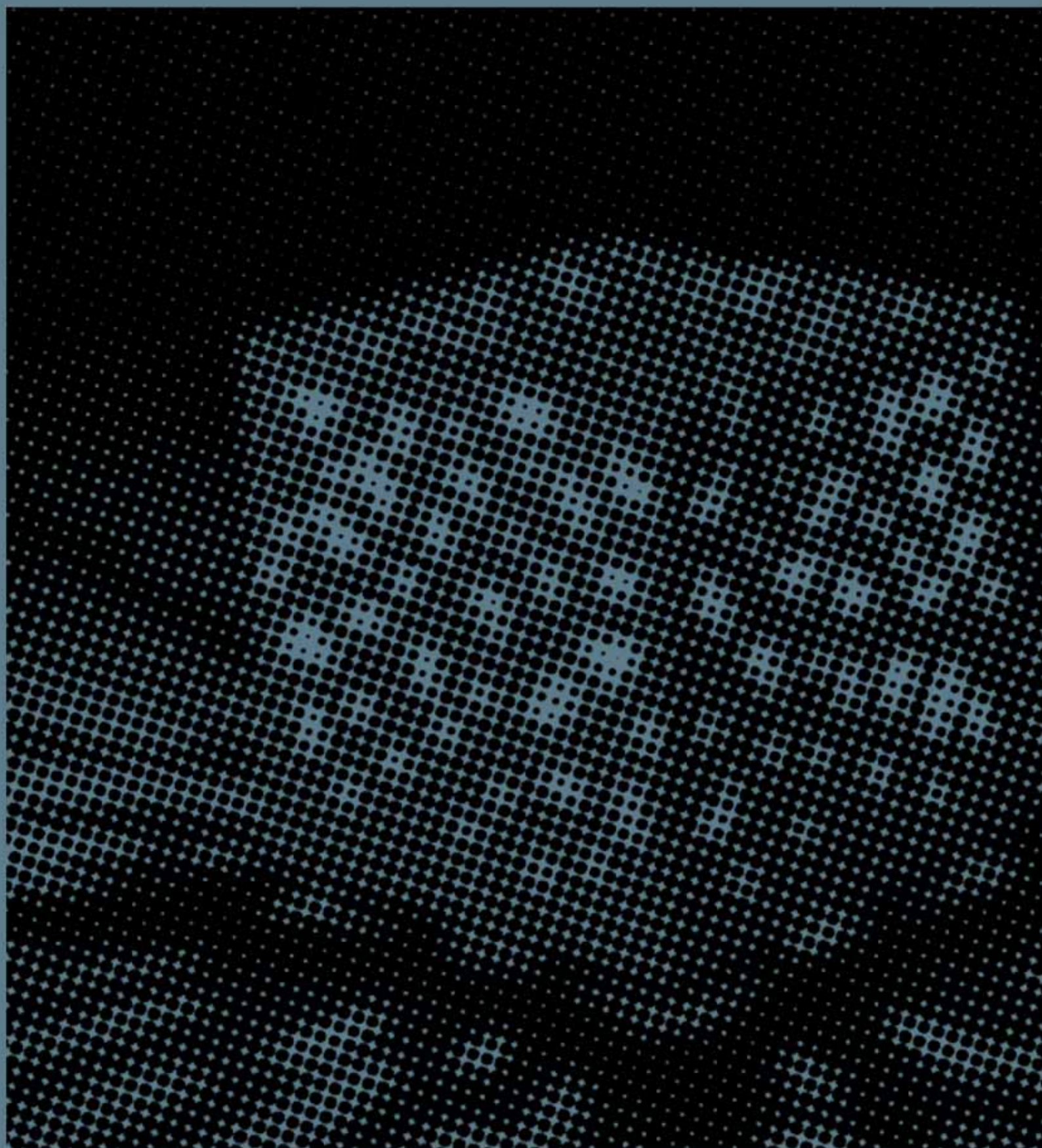

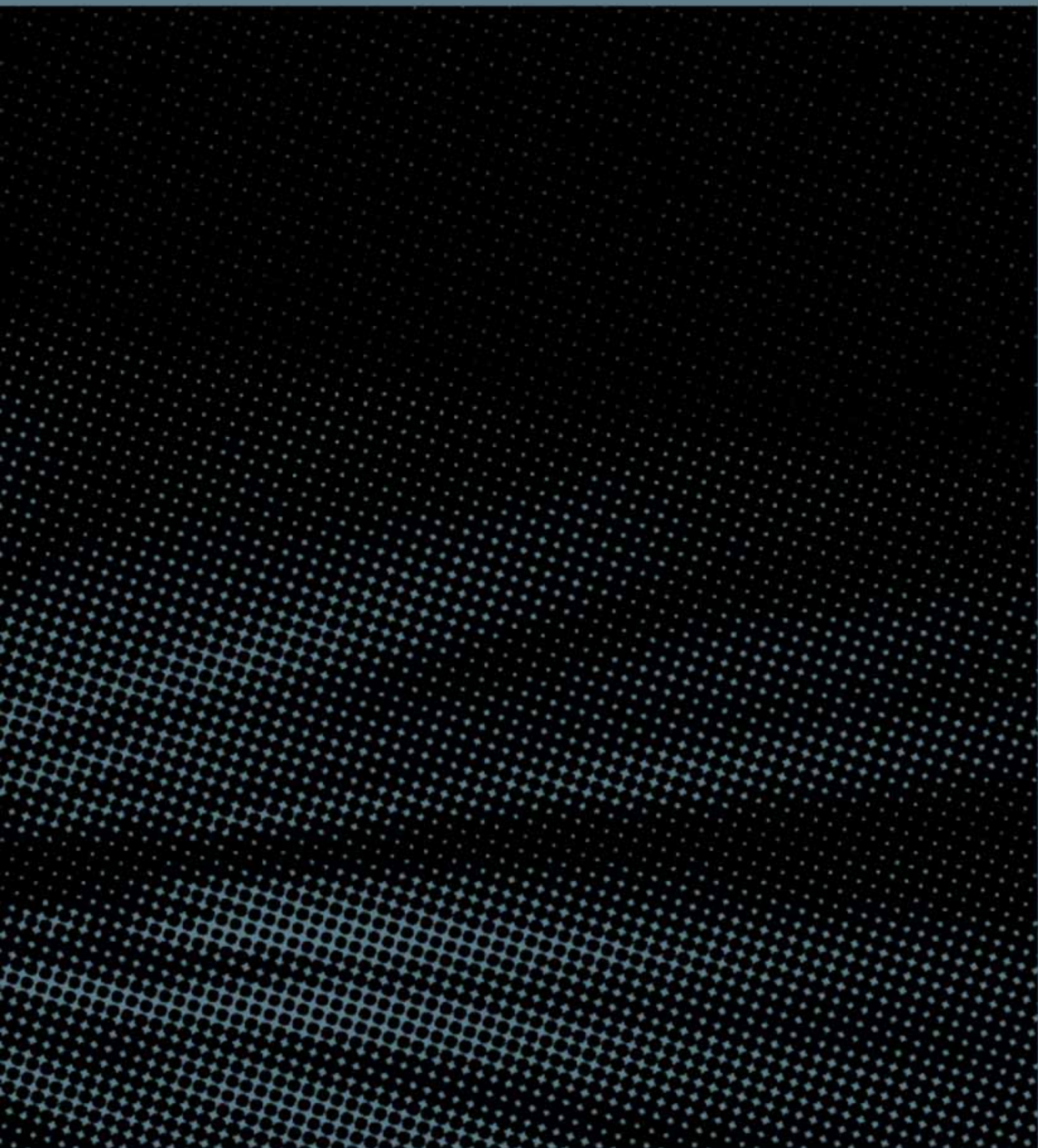

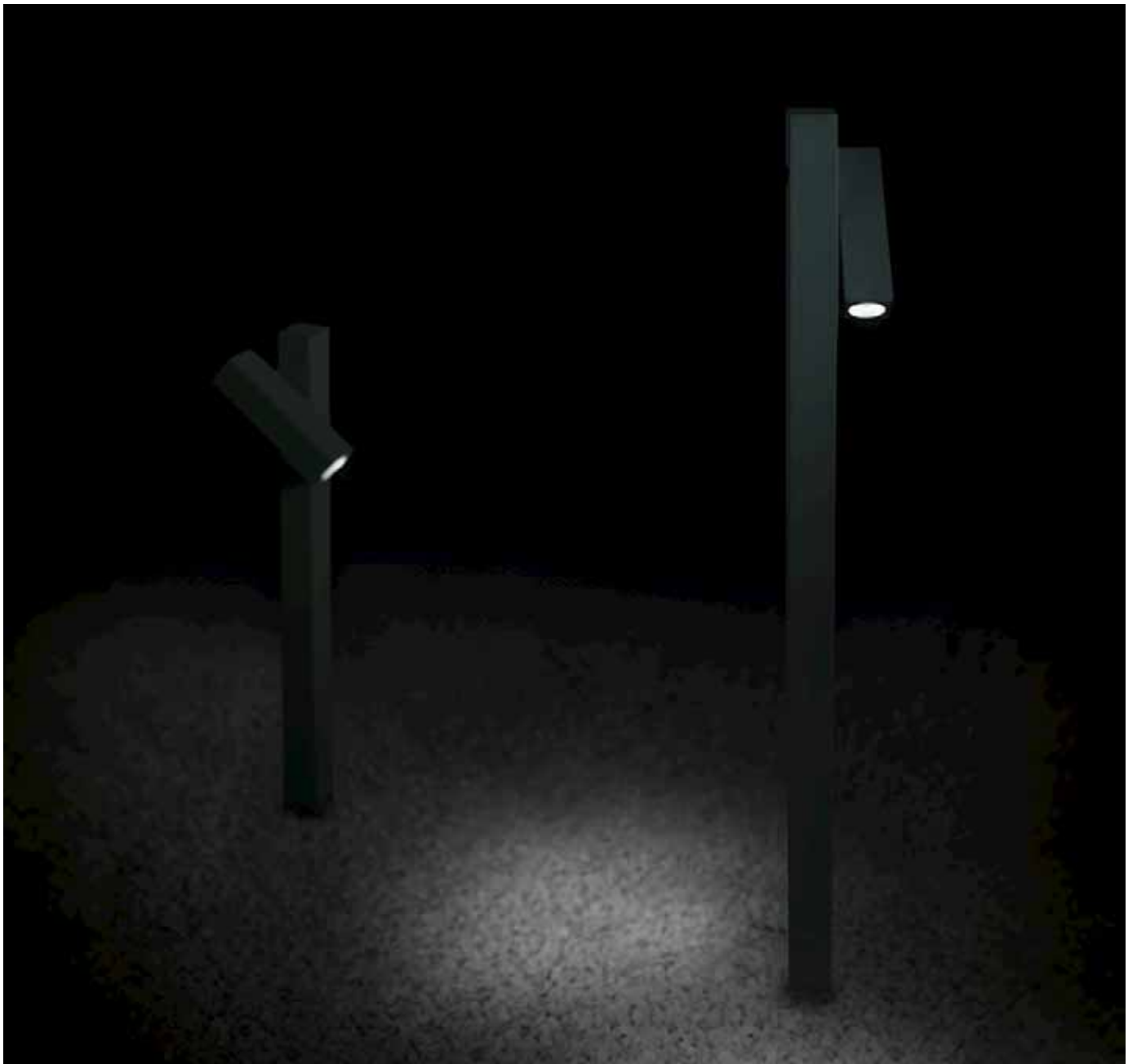

Magnet

J. L. Xuclà



LED 9,3W 544 lm 3000K

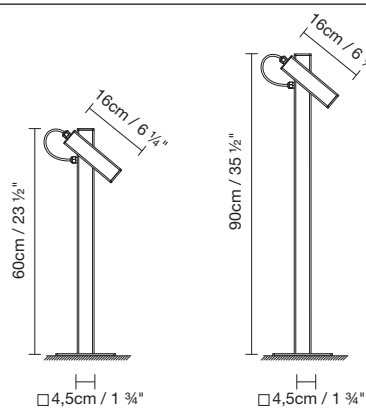

Baliza de acero para exterior, disponible en dos alturas. Posee un sistema magnético para orientar la cabeza lumínica.

Acabado: verde oliva.

Outdoor beacon lamp, available in two heights, featuring a magnetic system to angle the light head.

Finish: Olive green.

Pollerleuchte aus Stahl für Außenbereiche, lieferbar in zwei Höhen. Ist mit einem magnetischen System zur Ausrichtung des Leuchtenkopfes ausgestattet.

Ausführung: Olivgrün.



Banco de madera bossé para exterior e interior con iluminación a ambos lados. Lap Bench A se fija al suelo coincidiendo con una acometida prevista, mientras que Lap Bench B es portátil y posee una longitud de acometida máxima de 3,5 metros. Disponible en dos longitudes.

Acabados: gris hormigón y óxido.

Bossé wooden bench for indoors or outdoors. Lap Bench A may be connected to the ground or floor at a fixed connection point, while Lap Bench B is portable, with a 3.5-meter cable. Available in two lengths.

Finishes: Concrete grey and rust.

Beidseitig beleuchtete Bank aus bossiertem Holz für Außen- und Innenbereiche. Lap Bench A ist über einem festen Stromanschluss im Boden verankert, Lap Bench B ist tragbar und verfügt über ein 3,5 Meter langes Kabel. Lieferbar in zwei Längen.

Ausführung: Betongrau und oxidiert.

Fluor. 2 x 24W (2G11)
Tira LED 6,8W 630 lm 3000K

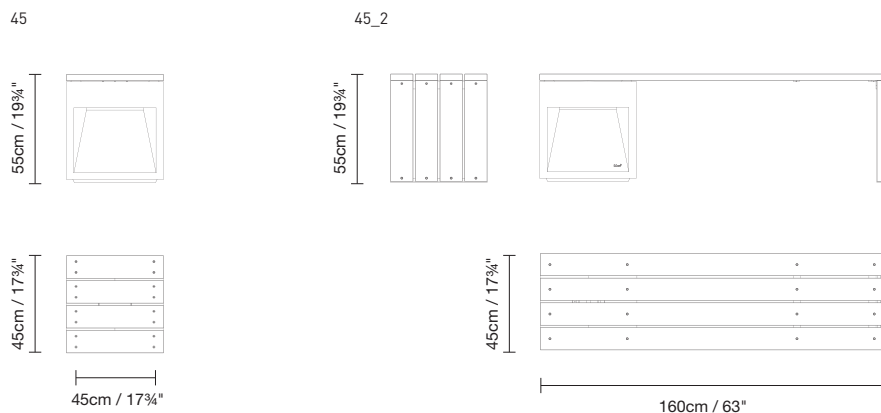



Lap Bench

David Abad

Familia de luminarias de exterior de formas geométricas, disponible en tres tamaños. Se fabrica en acero corten o acero inoxidable.

A line of outdoor lamps with geometric forms, available in three sizes. Made from corten or stainless steel.

Geometrisch designte Leuchten-Modellreihe für Außenbereiche, erhältlich in drei Größen. Wird in Cortenstahl oder Edelstahl hergestellt.

Sortiment von Außenleuchten mit geometrischen Formen, erhältlich in drei Größen. Gefertigt aus Cortenstahl oder Edelstahl.

- 12: Halóg. máx. 40W (G9)
- 20: Halóg. máx 60W (E27), Fluor. 18W (E27)
- 40: Halóg. máx. 100W (E27), Fluor. 26W (E27)

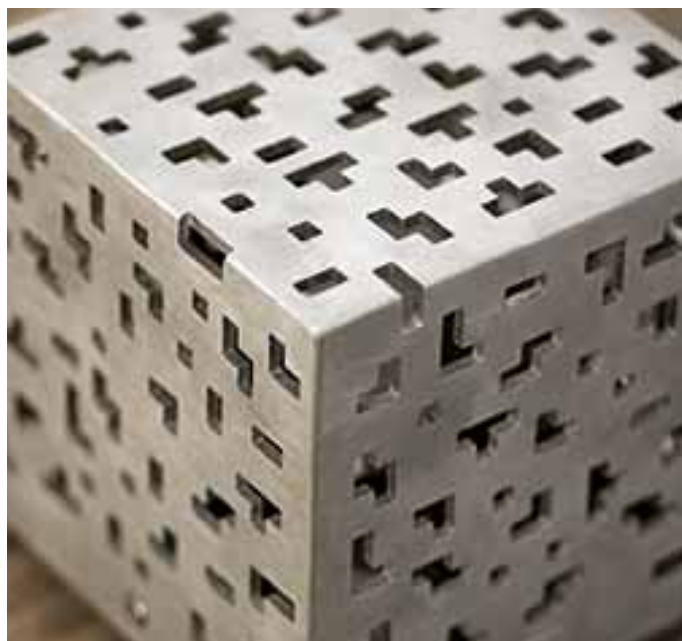
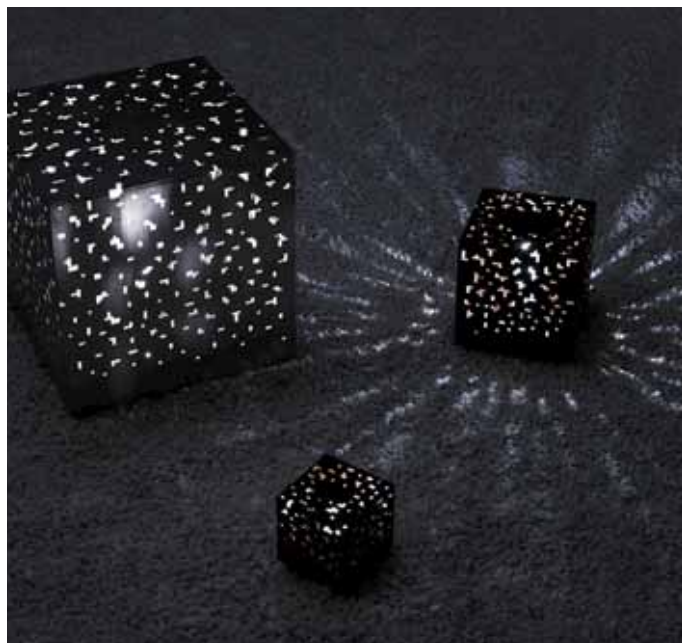
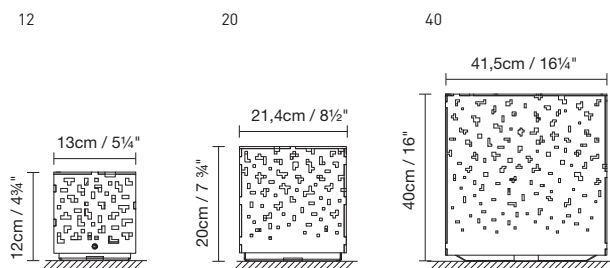



AMS

David Abad

Baliza para exterior que recrea un prisma hueco rectangular de ángulos redondeados. Estructura de aluminio. Disponible en tres tamaños.

Acabados: blanco, marrón, antracita y verde oliva, todos ellos mate.

Outside beacon in the form of a hollow, rectangular prism, with rounded corners. Aluminium frame. Available in three sizes.

Finishes: white, brown, anthracite, olive green, all of them matte.

Orientierungsleuchte für Außenbereiche, ein rechteckiges Prisma mit abgerundeten Ecken, das mit seiner Aussparung in der Mitte dem Licht förmlich einen Rahmen gibt. Die Struktur ist aus Aluminium Lieferbar in drei Größen.

Ausführungen: Weiß, Braun, Anthrazit und Olivgrün, jeweils matt.

 S: Fluor. 2 x 7W (2G7)
 o LED 5W PRI 230v SEC 24v
 M/L: Fluor. 2 x 7W (2G7)

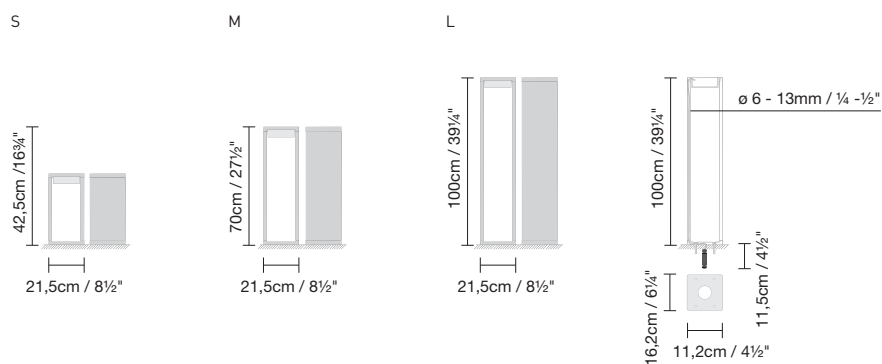



Frame

Mario Ruiz

Baliza para exterior fabricada en acero inoxidable pintado. El fuste está disponible en dos versiones: con un ángulo de 75° y de 90°. La cabeza de luz es orientable en el momento de su instalación. Se fabrica en tres alturas.

Acabado: Verde oliva.

Outdoor beacon lamp in painted stainless steel. The pillar is available in two versions: one with an angle of 75°, and one 90°. Head light is adjustable during installation. It is manufactured in three heights.

Finish: Olive green.

Pollerleuchte für Außenbereiche, gefertigt aus lackiertem Edelstahl. Der Pfosten ist in zwei Ausführungen erhältlich: Winkel von 75° und 90°. Der Leuchtaufsatz kann bei der Installation individuell ausgerichtet werden. Wird in drei Höhen hergestellt.

Ausführung: Olivgrün.

Halóg. metálico 50W (Gu10)
LED 9,5W 556 lm 3000K

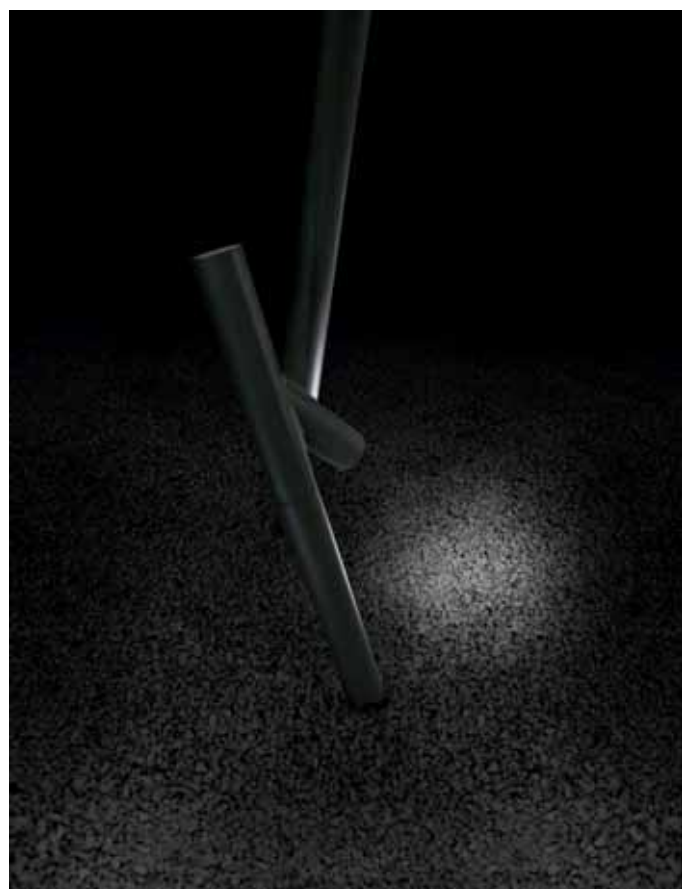
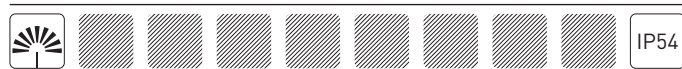
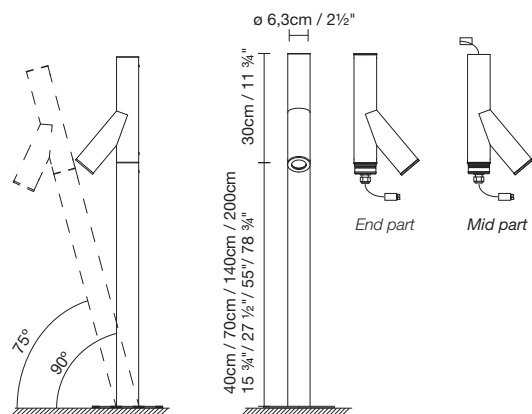

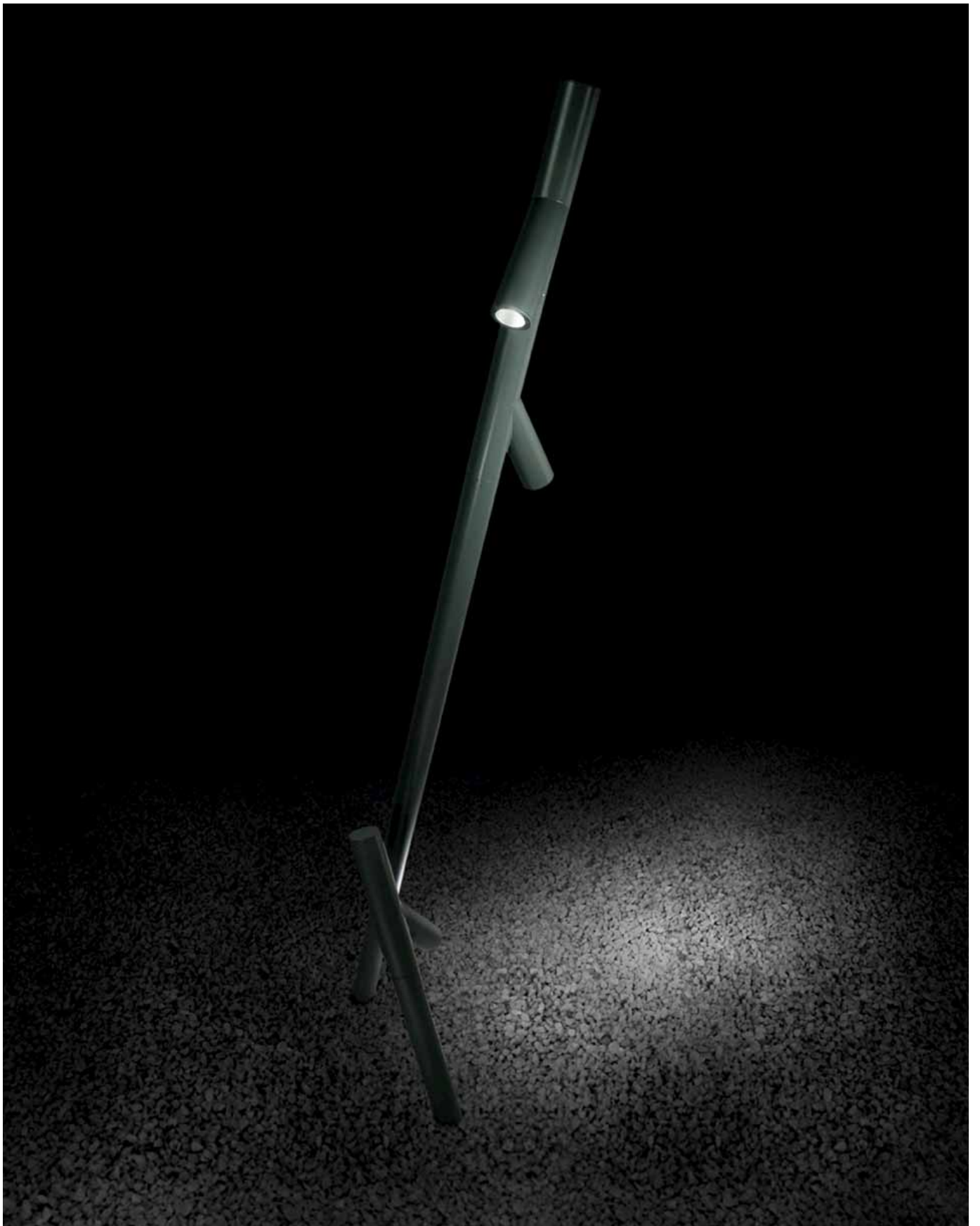

Junko

J. L. Xuclà

Luminaria de exterior y estructura de aluminio, que proporciona una iluminación angular directa. De formas lineales, 20/20 se comercializa en dos alturas, de 350 y 100 centímetros.

Outdoor lamp with an aluminium structure which provides direct angular lighting. With linear forms, the 20/20 is available in two different heights: 350 and 100 centimetres.

Außenleuchte mit Aluminiumstruktur und direkter, schräger Beleuchtung. Gerade Formen. 20/20 ist in zwei Höhen verfügbar: 350 und 100 Zentimeter.

- 100: Halogenuro Master Color CDMT mini 20W (PGJ5)
LED 17,5W 1300 lm 3000K CRI 80
- 350: Halogenuro 150W (G12)
LED 35W 2700 lm 3000K CRI 80

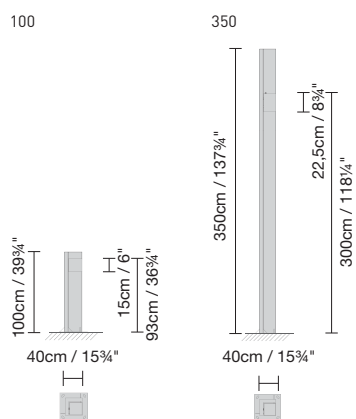



20/20

David Abad



www.grupoblux.com

B.LUX S.A. / VANLUX S.A.
Pol. Ind. Okamika, pab. 1
48.289 Gizaburuaga (Bizkaia, SPAIN)
T. (+34) 94 682 72 72
F. (+34) 94 682 49 02
info@grupoblux.com



B.lux S.A. y Vanlux S.A. se reservan el derecho de efectuar cualquier modificación y anulación de los productos y sus características técnicas, sin previo aviso.

B.lux S.A. y Vanlux S.A. reserve the right to make any modifications and remove products and their technical characteristics without prior notice.

B.lux S.A. y Vanlux S.A. behalten sich das Recht vor, Produkte bzw. Deren technische Eigenschaften ohne vorherige Ankündigung abzüandern oder zu streichen.